

ALVEXPO

Plastic and Cosmetic Surgery Instruments

- Making Health Care
- Discover a New To You

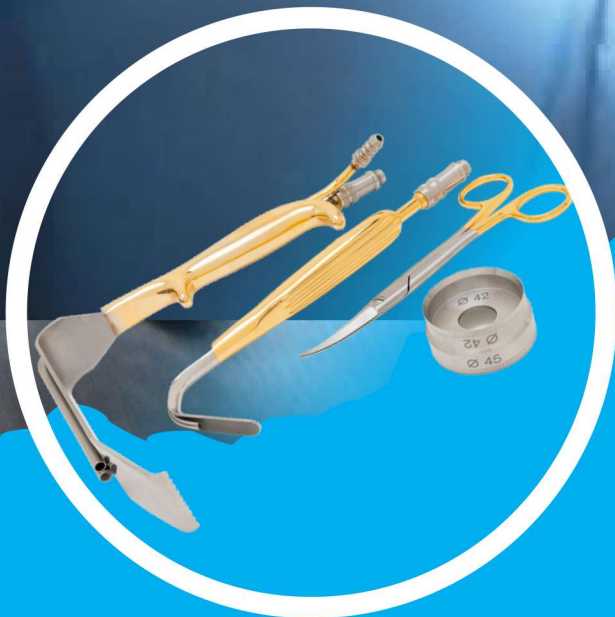

Contents

- Scalpel / Dermotomes
- Measuring Instruments
- Scissors
- Forceps
- Approximators Vessel Clips
- Haemostatic Forceps / Tissue and Intestinal Holding Forceps / Cotton Swap Forceps Sponge Holding Forceps
- Retractors / Soft Tissue Retractors for Maxillo Facial Surgery / Retractors Wound Spreader Self Retaining
- Needle Holders
- Mallets / Chisels / Elevators / Periosteal Elevators
- Nasal Specula / Nasal Saws
- Nasal Rasps / Septum Forceps / Bone Ronguers / Bone Cutting Forceps
- Lacrimal Dilators / Bone Crushers
- Instrument Trays / Basic Set for Plastic Surgery
- Numerical Index / Index
- Misceleneous Instruments



1:1

135 mm – 5₄"

EG-101-13

Titan
Titanium

Titan
Titanio
Titanio



1:1



1:1



1:1



1:1

Fig. 63

Fig. 64

Fig. 67

Fig. 69

EG-101-03

EG-101-04

EG-101-07

EG-101-09

Mikroklingen – Packung mit 25 Stück

Micro-Spare blade – package of 25 pieces

Micro-Lame de réchange paquet de 25 pièces

Micro-Hoja de cambio – paquete de 25 piezas

Micro-Lame di ricambio – confezione da 25 pezzi

Scalpel Handle



Standard	Standard	Barron				
Fig. 3	Fig. 4	Fig. 3	Fig. 3 R	Fig. 3 RG	Fig. 7K	Fig. 7
EG-102-03-A	EG-102-04	EG-102-03-B	EG-102-03-C	EG-102-03-D	EG-102-07-A	EG-102-07-B

Scalpel Blades



1:1
Fig. 10

EG-103-10T



1:1
Fig. 11

EG-103-11T



1:1
Fig. 12

EG-103-12T



1:1
Fig. 12d

EG-103-12DT



1:1
Fig. 15

EG-103-15T

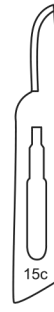

1:1
Fig. 15c

EG-103-15CT

doppelschneidend
double cutting edge
double tranchante
corta doble
a doppio taglio



1:1
Fig. 18

EG-103-18T

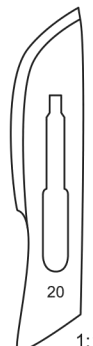

1:1
Fig. 20

EG-103-20T

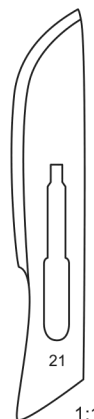

1:1
Fig. 21

EG-103-21T



1:1
Fig. 22

EG-103-22T

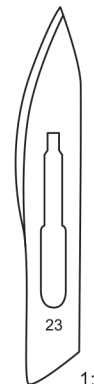

1:1
Fig. 23

EG-103-23T

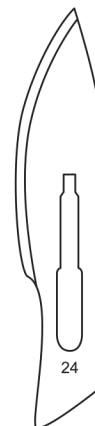

1:1
Fig. 24

EG-103-24T

Dermotomes



1:2

Tiersch

200 mm – 8"

EG-104-20



1:2

Schink

EG-104-30 300 mm – 12 "

komplett mit 1 Klinge und 2 Spannhaltern
complete with 1 blade and 2 plates
 complèt avec 1 lame et 2 plaques
completo con 1 hoja y 2 placas
 completo con 1 lama e 2 placche



1:2

EG-104-50

Ersatzklinge
spare blade
 lame de rechange
hoja de cambio
 lama di ricambio



1:2

Schink

EG-104-40

Spannplatte
Skin fi xing plate
 Plaque pour tendre la peau
Placa para extender la piel
 Placca per stendere la pelle

Dermotomes



1:2

Humby
310 m – 12,4"
EG-105-00

komplett mit 1 Klinge
complete with 1 blade
complet avec 1 lame
completo con 1 hoja
completo con 1 lama



1:2

EG-105-01

spare blade for RM-105-00, RM-105-02



Spare Blade

50, 60 mm

EG-105-03



1:2

Watson
300 mm – 12 "
EG-105-02

komplett mit 1 Klinge, Stange starr
complete with 1 blade, fi xed bar
complet avec 1 lame, tige fi x
completo con 1 hoja, barra fi jada
completo con 1 lama, barra fi ssa



Ø = 32 mm	Ø = 36 mm	Ø = 40 mm	Ø = 42 mm	Ø = 45 mm	Ø = 47 mm
EG-106-00-A	EG-106-00-B	EG-106-00-C	EG-106-00-D	EG-106-00-E	EG-106-00-F

Mamillenringe (stumpf)
Areola markers (blunt)
 Marqueurs pour l'aréole (mousses)
Marcadores para aréola (romos)
 Marcatori per areola (smussati)

Freeman

Ø = 34 mm	Ø = 36 mm	Ø = 38 mm	Ø = 42 mm	Ø = 45 mm	Ø = 50 mm
EG-106-01-A	EG-106-01-B	EG-106-01-C	EG-106-01-D	EG-106-01-E	EG-106-01-F



Mamillenringe (stumpf)
Areola markers (blunt)
 Marqueurs pour l'aréole (mousses)
Marcadores para aréola (romos)
 Marcatori per areola (smussati)

Chang

Ø = 38/42 mm

EG-106-02



1:2

Mamillerring (stumpf)
Areola marker (blunt)
 Marqueur pour l'aréole (mousses)
Marcador para aréola (romos)
 Marcatore per areola (smussati)

Grossman

Ø = 48/52 mm

EG-106-03



1:2

Mamillerring (stumpf)
Areola marker (blunt)
 Marqueur pour l'aréole (mousses)
Marcador para aréola (romos)
 Marcatore per areola (smussati)

Für präzises Markieren der Brustwarze bei:

- kombinierter Bruststraffung
- Verkleinerung des Brustwarzenhofes

For precise marking of the nipple during:

- combined breast-lifting
- reduction of the areola

Pour marquage exact du mamelon en cas de:

- lifting des seins combiné
- réduction de l'aréole

Para la marcación precisa del pezón en caso de:

- combinación con un lifting de la mama
- reducción del tamaño de la areola mamaria

Per la marcatura esatta del capezzolo in caso di:

- rassodamento combinato della mammella



100 mm – 4 "	EG-106-04
150 mm – 6 "	EG-106-05
200 mm – 8 "	EG-106-06
300 mm – 12 "	EG-106-07
500 mm – 20 "	EG-106-08

Leahands



EG-107-01

für Kinder
child size
pour enfants
para niños
per bambini



EG-107-02

für Erwachsene
adult size
pour adultes
para adultos
per adulti

EG-107-03

für Erwachsene, mit Silikonüberzug
adult size with silicone coating
pour adultes, avec couche de silicone
para adultos, con cubierta de silicon
per adulti, rivestito di silicone

EG-107-04

für Kinder, mit Silikonüberzug
child size with silicone coating
pour enfants, avec couche de silicone
para niños, con cubierta de silicon
per bambini, rivestito di silicone

□ Standard Cut

Hochwertige Scheren mit Standardschliff

High performance scissors with standard cutting edges

Ciseaux de haute qualité avec coupe standard

Tijeras de alta calidad con afiladura estándar

Forbici di altissima qualità con filettatura standard



■ SuperCut

Osteotomschliff und Mikrozahnung

Präzises Präparieren und minimal traumatisierender Schnitt

Osteotom edges and micro serration

Precise dissection and minimal traumatizing cut

Coupe ostéotome et dentelure micro

Dissection précise et minimal traumatisante

Corte osteotomo y dentado micro

Dissección precisa mínima traumática

Affilatura a forma di osteotomo e dentellatura micro

Dissezione precisa e taglio minimamente traumatizzante



■ TC Cut

Eingeschweisste Hartmetallschneiden mit Standardschliff

Lange Schnitthaltigkeit

Welded tungsten-carbide cutting edges

Long lasting cutting ability

Plaques en carbure de tungstène soudées dans les lames

Qualité de coupe continue

Placas de carburo de tungsteno soldadas en las hojas

Calidad de corte permanente

Lame saldate al carburo di tungsteno con filettatura standard

Lunga durata di taglio



TC SuperCut

Eingeschweisste Hartmetallschneiden, Osteotomschliff und Mikroverzahnung
Lange Schnitthaltigkeit, präzises Präparieren und minimal traumatisierender Schnitt

*Welded tungsten-carbide cutting edges, osteotom edges and micro serration
Long lasting cutting ability, precise dissection and minimal traumatizing cut*

Plaques en carbure de tungstène, coupe ostéotome et dentelure micro
Qualité de coupe continue, dissection précise et minimal traumatisante

*Placas de carburo de tungsteno, corte osteotomo y dentado micro
Calidad de corte permanente, dissección precisa mínima traumática*

Lame saldate al carburo di tungsteno con affilatura a forma di osteotomo e dentellatura micro
Lunga durata di taglio, dissezione precisa e taglio minimamente traumatizzante



Ceramic SuperCut

Eingeschweisste Hartmetallschneide mit Osteotomschliff und Mikroverzahnung, schwarze Keramikbeschichtung
Lange Schnitthaltigkeit durch hohe Oberflächenhärte der Beschichtung, blendfreie Oberfläche, präzises Präparieren und minimal traumatisierender Schnitt

*Welded tungsten-carbide cutting edges with osteotom edges and micro serration, black ceramic coating
Long lasting cutting ability due to high surface hardness of the coating, anti-glaring surface, better vision, precise dissection and minimal traumatizing cut*

Plaques en carbure de tungstène, coupe ostéotome et dentelure micro, surface céramisée
Qualité de coupe continue, dissection précise et minimal traumatisante, surface anti-éblouissante

*Placas de carburo de tungsteno, corte osteotomo y dentado micro, superficie cerámica
Calidad de corte permanente, dissección precisa mínima traumática, superficie antideslumbrante*

Lame saldate al carburo di tungsteno con affilatura a forma di osteotomo e dentellatura micro, rivestimento di ceramica.
Lunga durata di taglio grazie all'alta durezza della superficie. Superficie antiriflesso, dissezione precisa e taglio minimamente traumatizzante



Operating Scissors



Metzenbaum

STANDARD

140 mm – 5½ "	EG-110-01-A	EG-110-01-B
150 mm – 6 "	EG-110-02-A	EG-110-02-B
180 mm – 8 "	EG-110-03-A	EG-110-03-B
200 mm – 8 "	EG-110-04-A	EG-110-04-B
230 mm – 9 "	EG-110-05-A	EG-110-05-B

SUPERCUT

140 mm – 5½ "	EG-110-06-A	EG-110-06-B
150 mm – 6 "	EG-110-07-A	EG-110-07-B
180 mm – 8 "	EG-110-08-A	EG-110-08-B
200 mm – 8 "	EG-110-09-A	EG-110-09-B
230 mm – 9 "	EG-110-10-A	EG-110-10-B

TC CUT

140 mm – 5½ "	EG-110-11-A	EG-110-11-B
180 mm – 8 "	EG-110-12-A	EG-110-12-B
200 mm – 8 "	EG-110-13-A	EG-110-13-B
230 mm – 9 "	EG-110-14-A	EG-110-14-B

CERAMIC SUPERCUT

140 mm – 5½ "	EG-110-15-A	EG-110-15-B
180 mm – 8 "	EG-110-16-A	EG-110-16-B
200 mm – 8 "	EG-110-17-A	EG-110-17-B
230 mm – 9 "	EG-110-18-A	EG-110-18-B
250 mm – 9¾ "	EG-110-19-A	EG-110-19-B



Plastic Surgery

Operating Scissors



1:1

Metzenbaum Fino

<input type="checkbox"/> STANDARD	
140 mm – 5½ "	EG-111-14-A
180 mm – 8 "	EG-111-18-A
200 mm – 8 "	EG-111-20-A
<input checked="" type="checkbox"/> SUPERCUT	
140 mm – 5½ "	EG-111-14-B
180 mm – 8 "	EG-111-18-B
200 mm – 8 "	EG-111-20-B
<input checked="" type="checkbox"/> TC CUT	
140 mm – 5½ "	EG-111-14-C
180 mm – 8 "	EG-111-18-C
200 mm – 8 "	EG-111-20-C
<input checked="" type="checkbox"/> TC SUPERCUT	
180 mm – 8 "	EG-111-18-D
<input checked="" type="checkbox"/> CERAMIC SUPERCUT	
140 mm – 5½ "	EG-111-14-E
180 mm – 8 "	EG-111-18-E
200 mm – 8 "	EG-111-20-E



Baby Metzenbaum

<input type="checkbox"/> STANDARD		1:1
115 mm – 4½ "	EG-111-11-A	
<input checked="" type="checkbox"/> SUPERCUT		
115 mm – 4½ "	EG-111-11-B	
<input checked="" type="checkbox"/> TC CUT		
115 mm – 4½ "	EG-111-11-C	
<input checked="" type="checkbox"/> TC SUPERCUT		
115 mm – 4½ "	EG-111-11-D	
<input checked="" type="checkbox"/> CERAMIC SUPERCUT		
115 mm – 4½ "	EG-111-11-E	

Plastic Surgery

Operating Scissors



1:2

Lexer

<input type="checkbox"/> STANDARD	
160 mm – 6¼ "	EG-112-16-A
<input checked="" type="checkbox"/> SUPERCUT	
160 mm – 6¼ "	EG-112-16-B
<input checked="" type="checkbox"/> TC CUT	
160 mm – 6¼ "	EG-112-16-C
<input checked="" type="checkbox"/> TC SUPERCUT	
160 mm – 6¼ "	EG-112-16-D
<input checked="" type="checkbox"/> CERAMIC SUPERCUT	
160 mm – 6¼ "	EG-112-16-E



1:1



1:2

Mayo Lexer

<input checked="" type="checkbox"/> TC CUT	
165 mm – 6½ "	EG-112-16-F
<input checked="" type="checkbox"/> TC SUPERCUT	
165 mm – 6½ "	EG-112-16-G
<input checked="" type="checkbox"/> CERAMIC SUPERCUT	
165 mm – 6½ "	EG-112-16-H



1:1

Plastic Surgery

Operating Scissors



1:2



1:1

Mayo Stille

<input type="checkbox"/> STANDARD	
170 mm – 6¾ "	RM-113-17-A
<input checked="" type="checkbox"/> SUPERCUT	
170 mm – 6¾ "	RM-113-17-B
<input checked="" type="checkbox"/> TC CUT	
170 mm – 6¾ "	RM-113-17-C
<input checked="" type="checkbox"/> TC SUPERCUT	
170 mm – 6¾ "	RM-113-17-D
<input checked="" type="checkbox"/> CERAMIC SUPERCUT	
170 mm – 6¾ "	RM-113-17-E



1:1



Reynolds

<input type="checkbox"/> STANDARD	
140 mm – 5½ "	RM-113-14-A
160 mm – 6¼ "	RM-113-16-A
<input checked="" type="checkbox"/> CERAMIC SUPERCUT	
160 mm – 6¼ "	RM-113-16-B

Plastic Surgery

Operating Scissors



1:2

Joseph

<input type="checkbox"/> STANDARD	
150 mm – 6 "	EG-114-14-A
<input checked="" type="checkbox"/> SUPERCUT	
150 mm – 6 "	EG-114-14-B



1:1



1:2

Kelly

<input type="checkbox"/> STANDARD	
160 mm – 6¼ "	EG-114-16-A
<input checked="" type="checkbox"/> SUPERCUT	
160 mm – 6¼ "	EG-114-16-B
<input checked="" type="checkbox"/> TC CUT	
160 mm – 6¼ "	EG-114-16-C
<input checked="" type="checkbox"/> TC SUPERCUT	
160 mm – 6¼ "	EG-114-16-D
<input checked="" type="checkbox"/> CERAMIC SUPERCUT	
160 mm – 6¼ "	EG-114-16-E



1:1



1:2

Stevens

STANDARD

130 mm – 5 "

EG-115-13-A

SUPERCUT

130 mm – 5 "

EG-115-13-B

stumpf

blunt

mousses

roma

smusse



1:1



1:2

Iris

SUPERCUT

115 mm – 4½ "

EG-115-15-A

TC SUPERCUT

115 mm – 4½ "

EG-115-15-B

spitz

sharp

pointue

aguda

acuta



1:1



standard

Scheren aus rostfreiem Stahl mit Standardschliff für präzises Arbeiten.

Stainless steel scissors with standard cut for precise working.

Ciseaux d'acier inoxydable avec coupe standard pour des travaux précis.

Tijeras de acero inoxidable con corte standard para un trabajo preciso.

Forbici di acciaio inossidabile con fi lattura Standard per tagli precisi.

SU

super cut

Messerschliff und Mikroverzahnung für einen feinen minimal traumatisierenden Schnitt.

Knife edges and micro serration for a fine and minimally traumatizing cut.

Aiguisement tranchante et dents micro pour une coupe fine, peu traumatisante.

Hoja de bisturí y dentadura micro para un corte fino, mínimo traumatizante.

Affilatura a scalpello e dentellatura micro per uno taglio fine, minimo traumatizzante.

SUB

super cut

SuperCut Scheren mit schwarzen Griffen.

SuperCut scissors with black handles.

Ciseaux SuperCut avec anneaux noirs

Tijeras SuperCut con anillos negros

Forbici SuperCut con anelli neri

black handle



TC

tungsten carbide

Nahtlos aufgeschweisste, korrosionsfreie Hartmetallschneiden.

Seamless welded, corrosion-free tungsten carbide cutting edges.

Plaques en carbure de tungstène, non-corrosives, soudées homogènement dans les lames.

Placas de carburo de tungsteno soldadas homogéneamente y anticorrosiva en las hojas.

Congiunzione omogenea senza cordolo lame saldate al carburo di tungsteno.



SU TC

super cut

Nahtlos aufgeschweisste Hartmetallschneide mit Messerschliff und Mikroverzahnung

Tungsten carbide plates, seamlessly welded into the jaws. Knife edges and micro serration.

Plaques en carbure de tungstène, soudées homogènement das les lames. Aiguisement trachante et de

Placas de carburo de tungsteno soldadas homogéneamente y en las hojas. Hoja de bisturí y dentura m

lame con taglio in tungsteno, senza saldature del morso, con taglio delle lame e dentatura micro.

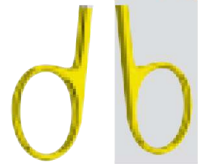

tungsten carbide

Plastic Surgery

Operating Scissors - Dissecting Scissors



Mayo

145 mm – 5 ⁷ / ₈ "	EG-117-14-A	EG-117-14-B
150 mm – 6" ¹ / ₄	EG-117-15-A	EG-117-14-B
170 mm – 6" ³ / ₄	EG-117-17-A	EG-117-14-B
230 mm – 9"	EG-117-23-A	EG-117-14-B

145 mm – 5 ⁷ / ₈ "	EG-117-14-A-SU	EG-117-14-B-SU
150 mm – 6" ¹ / ₄	EG-117-15-A-SU	EG-117-15-B-SU
170 mm – 6" ³ / ₄	EG-117-17-A-SU	EG-117-17-B-SU
230 mm – 9"	EG-117-23-A-SU	EG-117-23-B-SU

145 mm – 5 ⁷ / ₈ "	EG-117-14-A-SUB	EG-117-14-B-SUB
150 mm – 6" ¹ / ₄	EG-117-15-A-SUB	EG-117-15-B-SUB
170 mm – 6" ³ / ₄	EG-117-17-A-SUB	EG-117-17-B-SUB
230 mm – 9"	EG-117-23-A-SUB	EG-117-23-B-SUB

145 mm – 5 ⁷ / ₈ "	EG-117-14-A-TC	EG-117-14-B-TC
170 mm – 6" ³ / ₄	EG-117-17-A-TC	EG-117-17-B-TC
230 mm – 9"	EG-117-23-A-TC	EG-117-23-B-TC





1:2



1:1

Fig. 1



1:1

Fig. 2



1:1

Fig. 3

120 mm – 4 1/4"

EG-118-12-A

EG-118-12-B

EG-118-12-C



1:2



1:1

Fig. 1



1:1

Fig. 2



1:1

Fig. 3

120 mm – 4 1/4"

EG-118-12-D

EG-118-12-E

EG-118-12-F

Plastic Surgery

Operating Scissors - Dissecting Scissors



Lexer

160 mm – 6 $\frac{1}{4}$ "	EG-119-16-A	EG-119-16-B
210 mm - 8 $\frac{1}{4}$	EG-119-21-A	EG-119-21-B
160 mm – 6 $\frac{1}{4}$ "	EG-119-16-A-SU	EG-119-16-B-SU
160 mm – 6 $\frac{1}{4}$ "	EG-119-16-A-SUB	EG-119-16-B-SUB
160 mm – 6 $\frac{1}{4}$ "	EG-119-16-A-TC	EG-119-16-B-TC



Kelly

160 mm – 6 $\frac{1}{4}$ "	EG-119-16-A1	EG-119-16-B1
180 mm - 7"	EG-119-18-A	EG-119-18-B

Fistel Scheren
Fistula scissors
 Ciseaux pour fi stules
Tijeras para fi stulas
 Forbici per fi stole

Plastic Surgery

Operating Scissors - Dissecting Scissors



1:2



1:1



1:1

Peck-Josef

140 mm – 5 ₂ "	EG-120-14-A	EG-120-14-B
140 mm – 5 ₂ "	EG-120-14-A-SU	EG-120-14-B-SU
140 mm – 5 ₂ "	EG-120-14-A-SUB	EG-120-14-B-SUB
140 mm – 5 ₂ "	EG-120-14-A-TC	EG-120-14-B-TC
140 mm – 5 ₂ "	EG-120-14-A-SU-TC	EG-120-14-A-SU-TC



1:2

Brophy (Sullivan)

145 mm – 5 ₄ "	EG-120-14-A1	EG-120-14-B1
---------------------------	---------------------	---------------------



1:1



1:1



Ragenal Killner

130 mm

EG-120-13



Metzenbaum-Nelson

	Fig. 1	Fig. 2	Fig. 3
115 mm – 4½"	EG-121-11-A	EG-121-11-B	EG-121-11-C
145 mm – 5¾"	EG-121-14-A	EG-121-14-B	EG-121-14-C
150 mm – 6"	EG-121-15-A	EG-121-15-B	EG-121-15-C
180 mm – 7"	EG-121-18-A	EG-121-18-B	EG-121-18-C
200 mm – 8"	EG-121-20-A	EG-121-20-B	EG-121-20-C
230 mm – 9"	EG-121-23-A	EG-121-23-B	EG-121-23-C
250 mm – 9¾"	EG-121-25-A	EG-121-25-B	EG-121-25-C
280 mm – 11"	EG-121-28-A	EG-121-28-B	EG-121-28-C
300 mm – 12"	EG-121-30-A	EG-121-30-B	EG-121-30-C
145 mm – 5¾"	EG-121-14-A-SU	EG-121-14-B-SU	EG-121-14-C-SU
180 mm – 7"	EG-121-18-A-SU	EG-121-18-B-SU	EG-121-18-C-SU
200 mm – 8"	EG-121-20-A-SU	EG-121-20-B-SU	EG-121-20-C-SU
230 mm – 9"	EG-121-23-A-SU	EG-121-23-B-SU	EG-121-23-C-SU
145 mm – 5¾"	EG-121-14-A-SUB	EG-121-14-B-SUB	EG-121-14-C-SUB
180 mm – 7"	EG-121-18-A-SUB	EG-121-18-B-SUB	EG-121-18-C-SUB
200 mm – 8"	EG-121-20-A-SUB	EG-121-20-B-SUB	EG-121-20-C-SUB
230 mm – 9"	EG-121-23-A-SUB	EG-121-23-B-SUB	EG-121-23-C-SUB
115 mm – 4½"	EG-121-11-A-TC	EG-121-11-B-TC	EG-121-11-C-TC
145 mm – 5¾"	EG-121-14-A-TC	EG-121-14-B-TC	EG-121-14-C-TC
180 mm – 7"	EG-121-18-A-TC	EG-121-18-B-TC	EG-121-18-C-TC
200 mm – 8"	EG-121-20-A-TC	EG-121-20-B-TC	EG-121-20-C-TC
230 mm – 9"	EG-121-23-A-TC	EG-121-23-B-TC	EG-121-23-C-TC
250 mm – 9¾"	EG-121-25-A-TC	EG-121-25-B-TC	EG-121-25-C-TC
280 mm – 11"	EG-121-28-A-TC	EG-121-28-B-TC	EG-121-28-C-TC
300 mm – 12"	EG-121-30-A-TC	EG-121-30-B-TC	EG-121-30-C-TC



Plastic Surgery

Operating Scissors - Dissecting Scissors



Metzenbaum-Nelson

	Fig. 1	Fig. 2	Fig. 3
115 mm – 4 $\frac{1}{2}$ "	EG-122-11-A	EG-122-11-B	EG-122-11-C
145 mm – 5 $\frac{1}{4}$ "	EG-122-14-A	EG-122-14-B	EG-122-14-C
150 mm – 6 "	EG-122-15-A	EG-122-15-B	EG-122-15-C
180 mm – 7 "	EG-122-18-A	EG-122-18-B	EG-122-18-C
200 mm – 8 "	EG-122-20-A	EG-122-20-B	EG-122-20-C
230 mm – 9 "	EG-122-23-A	EG-122-23-B	EG-122-23-C
250 mm – 9 $\frac{1}{4}$ "	EG-122-25-A	EG-122-25-B	EG-122-25-C
280 mm – 11 "	EG-122-28-A	EG-122-28-B	EG-122-28-C
300 mm – 12 "	EG-122-30-A	EG-122-30-B	EG-122-30-C
145 mm – 5 $\frac{1}{4}$ "	EG-122-14-A-SU	EG-122-14-B-SU	EG-122-14-C-SU
180 mm – 7 "	EG-122-18-A-SU	EG-122-18-B-SU	EG-122-18-C-SU
200 mm – 8 "	EG-122-20-A-SU	EG-122-20-B-SU	EG-122-20-C-SU
230 mm – 9 "	EG-122-23-A-SU	EG-122-23-B-SU	EGF-122-23-C-SU
145 mm – 5 $\frac{1}{4}$ "	EG-122-14-A-SUB	EG-122-14-B-SUB	EG-122-14-C-SUB
180 mm – 7 "	EG-122-18-A-SUB	EG-122-18-B-SUB	EG-122-18-C-SUB
200 mm – 8 "	EG-122-20-A-SUB	EG-122-20-B-SUB	EG-122-20-C-SUB
230 mm – 9 "	EG-122-23-A-SUB	EG-122-23-B-SUB	EG-122-23-C-SUB
115 mm – 4 $\frac{1}{2}$ "	EG-122-11-A-TC	EG-122-11-B-TC	EG-122-11-C-TC
145 mm – 5 $\frac{1}{4}$ "	EG-122-14-A-TC	EG-122-14-B-TC	EG-122-14-C-TC
180 mm – 7 "	EG-122-18-A-TC	EG-122-18-B-TC	EG-122-18-C-TC
200 mm – 8 "	EG-122-20-A-TC	EG-122-20-B-TC	EG-122-20-C-TC
230 mm – 9 "	EG-122-23-A-TC	EG-122-23-B-TC	EG-122-23-C-TC
250 mm – 9 $\frac{1}{4}$ "	EG-122-25-A-TC	EG-122-25-B-TC	EG-122-25-C-TC
280 mm – 11 "	EG-122-28-A-TC	EG-122-28-B-TC	EG-122-28-C-TC
300 mm – 12 "	EG-122-30-A-TC	EG-122-30-B-TC	EG-122-30-C-TC



Plastic Surgery

Operating Scissors - Dissecting Scissors



Metzenbaum-Fino

	Fig. 1	Fig. 3	Fig. 1	Fig. 3
145 mm – 5 7/8"	EG-123-14-A	EG-123-14-B	EG-123-14-C	EG-123-14-D
180 mm – 7 "	EG-123-18-A	EG-123-18-B	EG-123-18-C	EG-123-18-D
200 mm – 8 "	EG-123-20-A	EG-123-20-B	EG-123-20-C	EG-123-20-D
230 mm – 9 "	EG-123-23-A	EG-123-23-B	EG-123-23-C	EG-123-23-D
145 mm – 5 7/8"	EG-123-14-A-SU	EG-123-14-B-SU	EG-123-14-C-SU	EG-123-14-D-SU
180 mm – 7 "	EG-123-18-A-SU	EG-123-18-B-SU	EG-123-18-C-SU	EG-123-18-D-SU
200 mm – 8 "	EG-123-20-A-SU	EG-123-20-B-SU	EG-123-20-C-SU	EG-123-20-D-SU
230 mm – 9 "	EG-123-23-A-SU	EG-123-23-B-SU	EG-123-23-C-SU	EG-123-23-D-SU
145 mm – 5 7/8"	EG-123-14-A-SUB	EG-123-14-B-SUB	EG-123-14-C-SUB	EG-123-14-D-SUB
180 mm – 7 "	EG-123-18-A-SUB	EG-123-18-B-SUB	EG-123-18-C-SUB	EG-123-18-D-SUB
200 mm – 8 "	EG-123-20-A-SUB	EG-123-20-B-SUB	EG-123-20-C-SUB	EG-123-20-D-SUB
230 mm – 9 "	EG-123-23-A-SUB	EG-123-23-B-SUB	EG-123-23-C-SUB	EG-123-23-D-SUB
145 mm – 5 7/8"	EG-123-14-A-TC	EG-123-14-B-TC	EG-123-14-C-TC	EG-123-14-D-TC
180 mm – 7 "	EG-123-18-A-TC	EG-123-18-B-TC	EG-123-18-C-TC	EG-123-18-D-TC
200 mm – 8 "	EG-123-20-A-TC	EG-123-20-B-TC	EG-123-20-C-TC	EG-123-20-D-TC
230 mm – 9 "	EG-123-23-A-TC	EG-123-23-B-TC	EG-123-23-C-TC	EG-123-23-D-TC



Plastic Surgery

Iris Scissors



90 mm – 3½"	EG-124-09-A	EG-124-09-B
115 mm – 4½"	EG-124-11-A	EG-124-11-B
115 mm – 4½"	EG-124-11-A-TC	EG-124-11-B-TC



90 mm – 3½"	EG-124-09-A1	EG-124-09-B1
100 mm – 4"	EG-124-10-A1	EG-124-10-B1
115 mm – 4½"	EG-124-11-A1	EG-124-11-B1
100 mm – 4"	EG-124-10-A-SU	EG-124-10-B-SU
100 mm – 4"	EG-124-10-A-SUB	EG-124-10-B-SUB

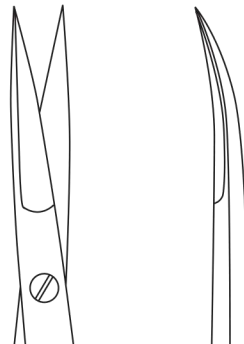

Jabaley

130 mm	EG-124-13-A	EG-124-13-B
130 mm	EG-124-13-A-SU	EG-124-13-B-SU
130 mm	EG-124-13-A-SUB	EG-124-13-B-SUB

Plastic Surgery

Fine Scissors



1:2



Strabismus-Schere

115 mm – 4	EG-125-11-A	EG-125-11-B
2		
115 mm – 4	EG-125-11-A-SU	EG-125-11-B-SU
2		
115 mm – 4	EG-125-11-A-SU	EG-125-11-B-SU



1:2

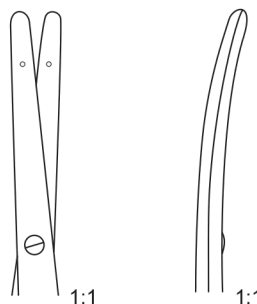

Knapp

120 mm	EG-125-10-A	EG-125-10-B
120 mm	EG-125-10-A-SU	EG-125-10-B-SU

stumpf
blunt
mousse
aguda
smusse



1:2

Gradle

90 mm – 3/4"
EG-125-09

gebogen, spitz
curved, pointed
courbes, pointue
curva, aguda
curve, acuta



Quinby

125 mm – 5 "	EG-126-12-A
--------------	--------------------



Neumann

120 mm – 4 1/4 "	EG-126-12-B
------------------	--------------------

S-förmig gebogen
S curved
 courbe en S
curva en S
 curve a forma di S



Mc Indoe

180 mm – 7 "	EG-126-18
180 mm – 7 "	EG-126-18-SU
180 mm – 7 "	EG-126-18-SUB

Kurzes Maul
Short jaw
 Mors court
Boca corta
 Taglio corto



Locklin

165 mm – 6 1/2 "	EG-126-16-A	EG-126-16-B
------------------	--------------------	--------------------

gerade, gezahnt
straight, saw edge
 droit, dentelée
recta, dentada
 rette, dentate



gebogen, gezahnt
curved, saw edge
 courbe, dentelée
curva, dentada
 curve, dentate

Plastic Surgery

Fine Operating Scissors



Converse

100 mm – 3³/₄"

EG-127-10

aufgewinkelt
angled

courbe vers le haut
angulado
angulato

1:2



Beuse

115 mm – 5 "

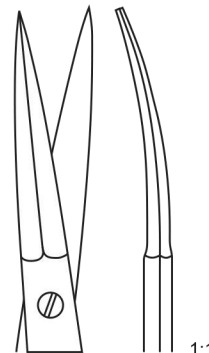

1:1

EG-127-11-A

leicht gebogen, spitz
slightly curved, pointed

légèrement courbe,
pointues
ligeramente curve, aguda
legeramente curve, acuta



1:1

EG-127-1A-B

leicht gebogen, stumpf
slightly curved, blunt

légèrement courbe,
mousses

ligeramente curva, roma
legeramente curve, smusso



1:2

Ribbon Stevens

95 mm – 3³/₄"

EG-127-09-A

EG-127-09-B

spitz – spitz
sharp – sharp
pointue – pointue
aguda – aguda
acuta – acuta



1:1



1:1



1:1

Ribbon Stevens

95 mm – 3³/₄"

EG-127-09-C

EG-127-09-D

stumpf – stumpf
blunt – blunt
mousse – mousse
roma – roma
smussa – smussa



1:1

Plastic Surgery



Stevens

100 mm – 4 "	EG-128-10-A	EG-128-10-B
110 mm – 4 1/4 "	EG-128-11-A	EG-128-11-B
100 mm – 4 "	EG-128-10-A-SU	EG-128-10-B-SU
110 mm – 4 1/4 "	EG-128-11-A-SU	EG-128-11-B-SU
100 mm – 4 "	EG-128-10-A-SU	EG-128-10-B-SU
110 mm – 4 1/4 "	EG-128-11-A-SU	EG-128-11-B-SU

spitz – spitz
 sharp – sharp
 pointue – pointue
 aguda – aguda
 acuta – acuta



EG

Stevens

100 mm – 4 "	EG-128-10-A1	EG-128-10-B1
110 mm – 4 1/4 "	EG-128-11-A1	EG-128-11-B1
100 mm – 4 "	EG-128-10-A1-SU	EG-128-10-B1-SU
110 mm – 4 1/4 "	EG-128-11-A1-SU	EG-128-11-B1-SU
100 mm – 4 "	EG-128-10-A1-SU	EG-128-10-B1-SU
110 mm – 4 1/4 "	EG-128-11-A1-SU	EG-128-11-B1-SU

stumpf – stumpf
 blunt – blunt
 mousse – mousse
 roma – roma
 smussa – smussa

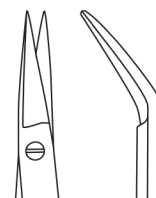

Converse Daniel

95 mm

EG-128-09

black line



Reynolds (Jameson)

160 mm – 6 ¹ / ₄ "	EG-129-16-A	EG-129-18-B
180 mm – 7 "	EG-129-18-A	EG-129-18-B
160 mm – 6 ¹ / ₄ "	EG-129-16-A-SU	EG-129-18-B-SU
180 mm – 7 "	EG-129-18-A-SU	EG-129-18-B-SU
160 mm – 6 ¹ / ₄ "	EG-129-16-A-SUB	EG-129-18-B-SUB
180 mm – 7 "	EG-129-18-A-SUB	EG-129-18-B-SUB



Kilner (Ragnell)

120 mm – 4 ¹ / ₄ "	EG-129-12
150 mm – 6 "	EG-129-15
120 mm – 4 ¹ / ₄ "	EG-129-12-SU
150 mm – 6 "	EG-129-15-SU
180 mm – 7 "	EG-129-18-SU
200 mm – 8 "	EG-129-20-SU
120 mm – 4 ¹ / ₄ "	EG-129-12-SUB
150 mm – 6 "	EG-129-15-SUB
180 mm – 7 "	EG-129-18-SUB
200 mm – 8 "	EG-129-20-SUB
120 mm – 4 ¹ / ₄ "	EG-129-12-TC
150 mm – 6 "	EG-129-15-TC



Joseph

140 mm – 5½"



1:1



1:1

EG-130-14-A	EG-130-14-B
--------------------	--------------------



Gorney

180 mm – 7¼"

230 mm – 9"

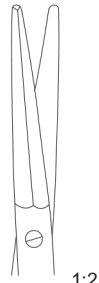

1:2

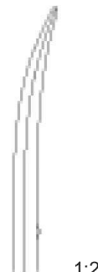

1:2

EG-130-18-A-SU	EG-130-18-B-SU
EG-130-23-A-SU	EG-130-23-B-SU

EG-130-18-A-SUB	EG-130-18-B-SUB
EG-130-23-A-SUB	EG-130-23-B-SUB

EG-130-19-A-TC	EG-130-19-B-TC
EG-130-23-A-TC	EG-130-23-B-TC



Gorney Platysma

230 mm – 9"	EG-131-23-A-SU	EG-131-23-B-SU
230 mm – 9"	EG-131-23-A-SUB	EG-131-23-B-SUB
230 mm – 9"	EG-131-23-A-TC	EG-131-23-B-TC

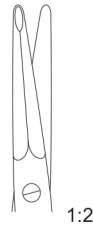

1:2



1:2



Gorney-Freeman

190 mm – 7 $\frac{1}{2}$ "	EG-131-19-A	EG-131-19-B
190 mm – 7 $\frac{1}{2}$ "	EG-131-19-A-SU	EG-131-19-B-SU
190 mm – 7 $\frac{1}{2}$ "	EG-131-19-A-SUB	EG-131-19-B-SUB
190 mm – 7 $\frac{1}{2}$ "	EG-131-19-A-TC	EG-131-19-B-TC
190 mm – 7 $\frac{1}{2}$ "	EG-131-19-A-SU-TC	EG-131-19-B-SU-TC

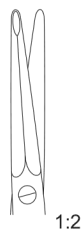

1:2

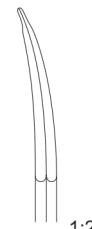

1:2



Gorney-Delicate

205 mm – 8 $\frac{1}{4}$ "	EG-132-20-SU
205 mm – 8 $\frac{1}{4}$ "	EG-132-20-SUB
205 mm – 8 $\frac{1}{4}$ "	EG-132-20-TC
205 mm – 8 $\frac{1}{4}$ "	EG-132-20-SU-TC

gebogen
curved
 courbe
curva
 curve

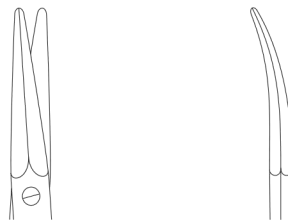

Kaye

145 mm – 5 $\frac{1}{4}$ "	EG-132-14-A-SU	EG-132-14-B-SU
185 mm – 7 "	EG-132-18-A-SU	EG-132-18-B-SU
230 mm – 9 "	EG-132-23-A-SU	EG-132-23-B-SU
145 mm – 5 $\frac{1}{4}$ "	EG-132-14-A-SUB	EG-132-14-B-SUB
185 mm – 7 "	EG-132-18-A-SUB	EG-132-18-B-SUB
230 mm – 9 "	EG-132-23-A-SUB	EG-132-23-B-SUB
145 mm – 5 $\frac{1}{4}$ "	EG-132-14-A-TC	EG-132-14-B-TC
185 mm – 7 "	EG-132-18-A-TC	EG-132-18-B-TC
230 mm – 9 "	EG-132-23-A-TC	EG-132-23-B-TC
145 mm – 5 $\frac{1}{4}$ "	EG-132-14-A-SU-TC	EG-132-14-B-SU-TC
185 mm – 7 "	EG-132-18-A-SU-TC	EG-132-18-B-SU-TC
230 mm – 9 "	EG-132-23-A-SU-TC	EG-132-23-B-SU-TC

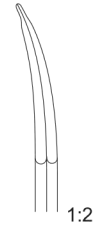
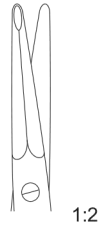

Freeman-Kaye

185 mm – 7 "	EG-133-18-A-SU	EG-133-18-B-SU
185 mm – 7 "	EG-133-18-A-SUB	EG-133-18-B-SUB
185 mm – 7 "	EG-133-18-A-TC	EG-133-18-B-TC
185 mm – 7 "	EG-133-18-A-SU-TC	EG-133-18-B-SU-TC

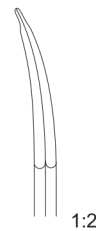
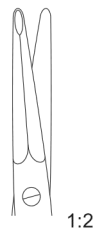

Aufricht

150 mm – 5,4"	EG-133-15-A-SU	EG-133-15-B-SU
150 mm – 5,4"	EG-133-15-A-SUB	EG-133-15-B-SUB

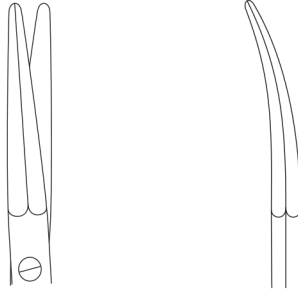

Kahn

145 mm – 5½"	EG-134-14-A	EG-134-14-B
180 mm – 7"	EG-134-18-A	EG-134-18-B

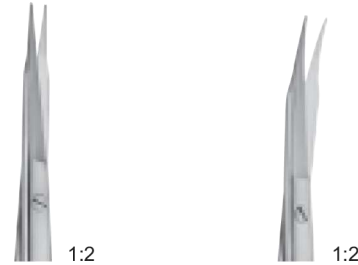

Goldman-Fox

130 mm – 5"	EG-134-13-A	EG-134-13-B
130 mm – 5"	EG-134-13-A-SU	EG-134-13-B-SU
130 mm – 5"	EG-134-13-A-SUB	EG-134-13-B-SUB
130 mm – 5"	EG-134-13-A-SU-TC	EG-134-13-B-SU-TC

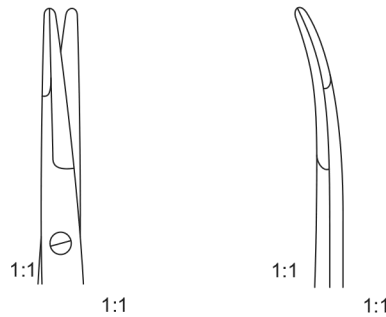

Kaye Ribbon Type

115 mm – 4½"	EG-134-11-A	EG-134-11-B
--------------	--------------------	--------------------

Plastic Surgery

Facelift Scissors

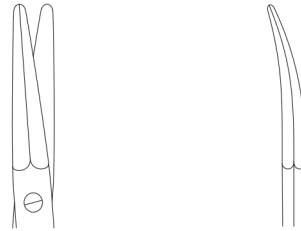

Rees

170 mm – 6 7/8"	EG-135-17-A	EG-135-17-B
205 mm –	EG-135-20-A	EG-135-20-B
170 mm – 6 7/8"	EG-135-17-A-SU	EG-135-17-B-SU
205 mm –	EG-135-20-A-SU	EG-135-20-B-SU
170 mm – 6 7/8"	EG-135-17-A-SUB	EG-135-17-B-SUB
205 mm –	EG-135-20-A-SUB	EG-135-20-B-SUB
170 mm – 6 7/8"	EG-135-17-A-TC	EG-135-17-B-TC
205 mm –	EG-135-20-A-TC	EG-135-20-B-TC



Rees Bulldog

130 mm – 5"

EG-135-13

leicht gebogen
slightly curved
 légèrement courbe
ligeramente curva
 legermente curve

1:2



Davis

170 mm – 6 7/8"

EG-135-17-A1

170 mm – 6 7/8"

EG-135-17-A1-SJ

170 mm – 6 7/8"

EG-135-17-A1-SUB

1:2



Gregory

145 mm – 5 $\frac{1}{2}$ "

EG-136-14-TC

leicht gebogen
slightly curved
 légèrement courbe
ligeramente curva
 legermente curve

1:2

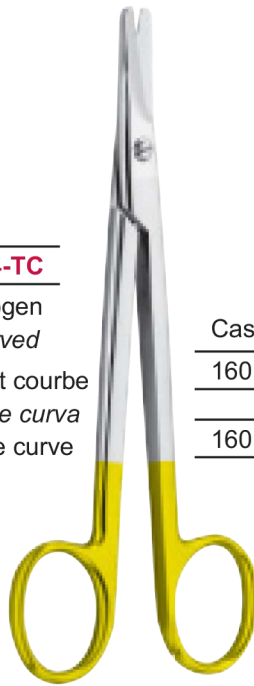

1:2

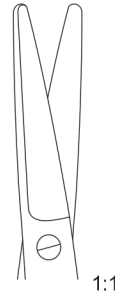

1:1



1:1

Castanares

160 mm – 6 $\frac{1}{4}$ "

EG-136-16-A

EG-136-16-B

160 mm – 6 $\frac{1}{4}$ "

EG-136-16-A-TC

EG-136-16-B-TC



Fomon

130 mm

EG-136-13

gewinkelt
angled
 angulée
angulado
 angulato



Fomon

155 mm

EG-136-15

blackline

Plastic Surgery



Knight

180 mm – 7 "	EG-137-18
--------------	------------------

 gewinkelt
angled
 angulée
angulado
 angulato

1:2



Fomon

135 mm – 5 ₄ "	EG-137-13
135 mm – 5 ₄ "	EG-137-13-SU
135 mm – 5 ₄ "	EG-137-13-SUB

stark gebogen
strongly curved
 fortement courbe
fuertemente curva
 fortamente curve

1:2



Boettcher

180 mm – 7 "	EG-137-18-A
--------------	--------------------

1:2



Thorek

190 mm – 7 ₂ "	EG-137-19
---------------------------	------------------

1:2



1:2



1:1



1:1

Shea

120 mm – 4 ₄	EG-138-12-A	EG-138-12-B
120 mm – 4 ₄	EG-138-12-A-SU	EG-138-12-B-SU
120 mm – 4 ₄	EG-138-12-A-SUB	EG-138-12-B-SUB

spitz
pointed
pointue
aguda
acuta



1:2



1:1



1:1

Bonn

80 mm – 3 ₄	EG-138-08-A	EG-138-08-B
------------------------	--------------------	--------------------



Joseph Daniel

150 mm	EG-138-15-A	EG-138-15-B
--------	--------------------	--------------------



Plastic Surgery

Blepharoplasty Scissors



Par-Type

115 mm – 4½"	EG-139-11-A	EG-139-11-B
145 mm – 5¾"	EG-139-14-A	EG-139-14-B
115 mm – 4½"	EG-139-11-A-SU	EG-139-11-B-SU
145 mm – 5¾"	EG-139-14-A-SU	EG-139-14-B-SU
115 mm – 4½"	EG-139-11-A-SUB	EG-139-11-B-SUB
145 mm – 5¾"	EG-139-14-A-SUB	EG-139-14-B-SUB
115 mm – 4½"	EG-139-11-A-TC	EG-139-11-B-TC
145 mm – 5¾"	EG-139-14-A-TC	EG-139-14-B-TC
115 mm – 4½"	EG-139-11-A-SU-TC	RM-139-11-B-SU-TC
145 mm – 5¾"	EG-139-14-A-SU-TC	RM-139-14-B-SU-TC



1:1



1:1

Greenberg Par

115 mm – 4½"	EG-139-15-A	EG-139-15-B
115 mm – 4½"	EG-13915-A-SU	EG-139-15-SU
115 mm – 4½"	EG-139-15-A-SUB	EG-139-15-A-SUB
115 mm – 4½"	EG-139-15-A-TC	EG-139-15-A-TC
1:2 115 mm – 4½"	EG-139-15-A-SU-TC	EG-139-15-A-SU-TC



Universal HM

120 mm

RM-139-12

Plastic Surgery

Blepharoplasty Scissors



1:2



1:1



1:1

Kaye Blepharoplasty

115 mm – 4½	EG-140-11-A	EG-140-11-B
115 mm – 4½	EG-140-11-A-SU	EG-140-11-B-SU
115 mm – 4½	EG-140-11-A-SUB	EG-140-11-B-SUB
115 mm – 4½	EG-140-11-A-TC	EG-140-11-B-TC
115 mm – 4½	EG-140-11-A-SU-TC	EG-140-11-B-SU-TC

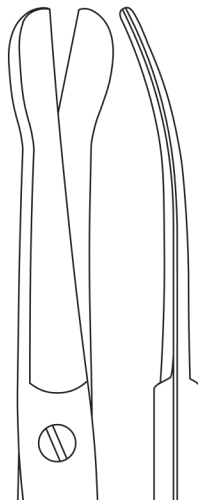

20 cm - 8"

EG-140-20-A-SU

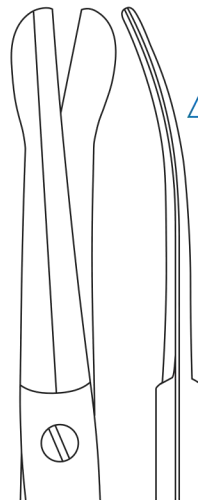

20 cm - 8"

EG-140-20-B-SU

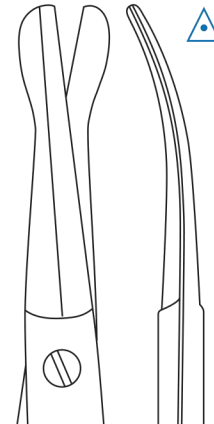

15 cm - 6"

EG-140-20-C-SU

Solz

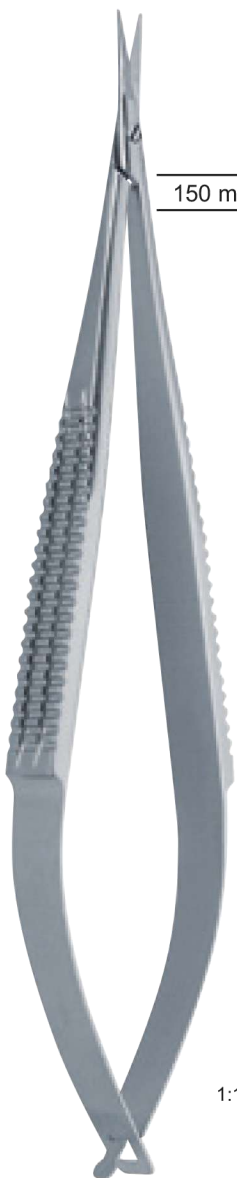

1:1



1:1

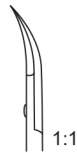

1:1

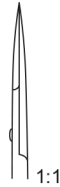

1:1

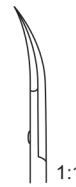

1:1

150 mm – 6"	EG-141-15-A	EG-141-15-B	EG-141-15-C	EG-141-15-D
gerade, Schneide <i>blades</i>	gebogen, Schneide <i>curved, blades</i>	gerade, Schneide <i>straight, blades</i>	gebogen, Schneide <i>curved,</i>	
droite, lames courtes <i>recta, hojas cortas</i>	courbe, lames courtes <i>curva, hojas cortas</i>	droite, lames longues <i>recta, hojas largas</i>	courbe, lames longues <i>curva, hojas largas</i>	
retta, lama corta	curva, lama corta	retta, lama lunga	curva, lama lunga	



1:1



1:1

150 mm – 6"	EG-141-15-E	EG-141-15F
gerade, gerade, <i>edge</i>	<i>curved,</i>	
droite, dentelée <i>recta, dentadas</i>	courbe, dentelée <i>curva, dentadas</i>	
retta, dentata	curva, dentata	

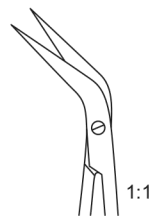

1:1

150 mm – 6"	EG-141-15-G
180 mm – 7"	EG-141-18-A

kniegebogen, 45°
angled on flat, 45°
angulaire, 45°
acodada, 45°
angolata, 45°

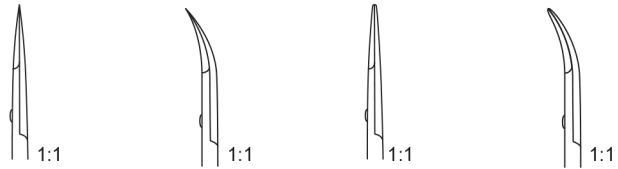

145 mm – 5 3/4"	EG-142-14-A	EG-142-14-B	EG-142-14-C	EG-142-14-D
180 mm – 7"	EG-142-18-A	EG-142-18-B	EG-142-18-C	EG-142-18-D

	glatt <i>smooth</i>	gerade,spitz <i>straight,sharp</i>	gebogen,spitz <i>curved,sharp</i>	gerade,stumpf <i>straight,blunt</i>	gebogen, <i>curved,</i>
lames courtes 8mm, lisses <i>hojas cortas 8 mm, lisos</i> lama corta 8mm, liscia		droites, pointues <i>rectas, agudas</i> retta, acuta	courbes, pointues <i>curvas, agudas</i> curva, acuta	droites, mousses <i>rectas, romas</i> retta, smussa	courbes, mousses <i>curvas, romas</i> curva, smussa

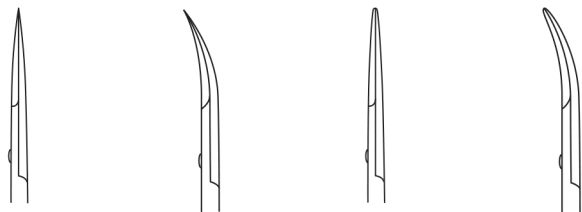

145 mm – 5 3/4"	EG-142-14-A1	EG-142-14-B1	EG-142-14-C1	EG-142-14-D1
180 mm – 7"	EG-142-18-A1	EG-142-18-B1	EG-142-18-C1	EG-142-18-D1

lange <i>long</i>	glatt <i>smooth</i>	gerade,spitz <i>straight,sharp</i>	gebogen,spitz <i>curved,sharp</i>	gerade,stumpf <i>straight,blunt</i>	gebogen, <i>curved,</i>
lames longues 14mm, lisses <i>hojas largas 14 mm, lisos</i> lama lunga 14 mm, liscia		droites, pointues <i>rectas, agudas</i> retta, acuta	courbes, pointues <i>curvas, agudas</i> curva, acuta	droites, mousses <i>rectas, romas</i> retta, smussa	courbes, mousses <i>curvas, romas</i> curva, smussa

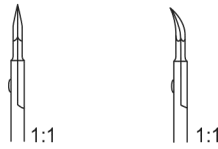

Vannas

	7 mm Ø	7 mm Ø
120 mm – 5 "	EG-143-12-A	EG-143-12-B

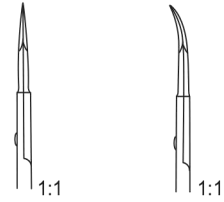

Vannas

	8 mm Ø	8 mm Ø
150 mm – 6 "	EG-143-15-A	EG-143-15-B

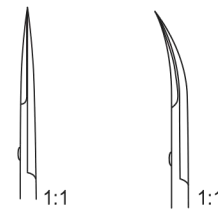

Castroviejo

	8 mm Ø	8 mm Ø
150 mm – 6 "	EG-143-15-A1	EG-143-15-B1

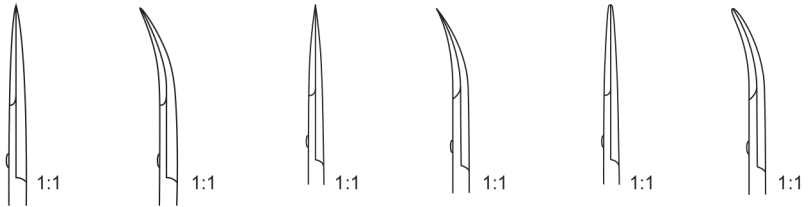

	180 mm - 7"	180mm - 7"	180mm - 7"	180mm - 7"	180mm - 7"	180mm - 7"
8 mm Ø	EG-144-08-A	EG-144-08-B	EG-144-08-C	EG-144-08-D	EG-144-08-E	EG-144-08-F
10 mm Ø	EG-144-10-A	EG-144-10-B	EG-144-10-C	EG-144-10-D	EG-144-10-E	RM-144-10-F

Plastic Surgery

Dressing Forceps - Dissecting Forceps



Semken

125 mm – 5 "	EG-145-12-A	EG-145-12-B
150 mm – 6 "	EG-145-15-A	EG-145-15-B



Cushing

175 mm – 7 "	EG-145-17-A	EG-145-17-B
175 mm – 7 "	EG-145-17-A-TC	EG-145-17-B-TC



Gillies
150 mm – 6"
EG-146-15-A



Mc Indoe
150 mm – 6" **EG-146-15-B**
150 mm – 6" **EG-146-15-B-TC**



Wangensteen
150 mm – 6" **EG-146-15C**
230 mm – 9" **EG-146-23**



1:2



1:1



1:1



1:1

Oehler

140 mm – 5 $\frac{1}{2}$ "	160 mm – 6 $\frac{1}{4}$ "	180 mm – 7"
EG-146-14-TC	EG-146-16-TC	EG-146-18-TC



1:1



1:1



1:1

200 mm – 8"	250 mm – 9 $\frac{1}{4}$ "	300 mm – 12"
EG-146-20-TC	EG-146-25-TC	EG-146-30-TC

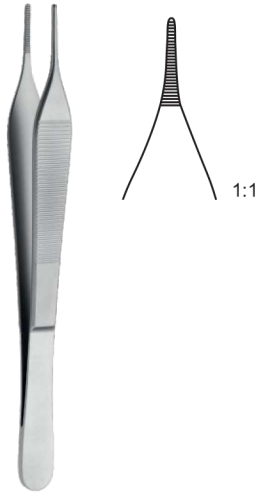

Adson

120 mm – 4 1/4"	EG-147-12-A
150 mm – 6"	EG-147-15-A
120 mm – 4 1/4"	EG-147-12-TC
150 mm – 6"	EG-147-15-TC

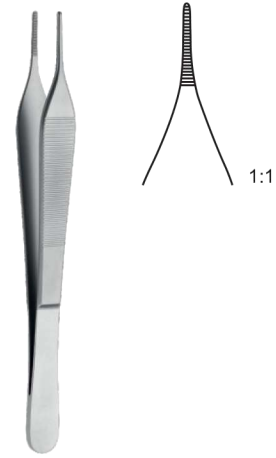

Micro-Adson

120 mm – 4 1/4"	EG-147-12-B
150 mm – 6"	EG-147-15-B



Adson-Graefe

120 mm – 4 1/4"	EG-147-12-A1
-----------------	---------------------



Adson Brown

120 mm – 4 1/4"	EG-147-12-B1	EG-147-12-C1
120 mm – 4 1/4"	EG-147-12-B1-C	EG-147-12-C1-TC

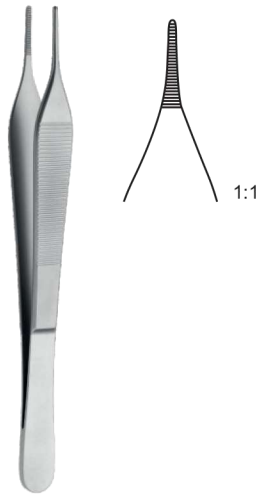

Adson

120 mm – 4 ¹ / ₄ "	EG-147-12-A
150 mm – 6"	EG-147-15-A
120 mm – 4 ¹ / ₄ "	EG-147-12-TC
150 mm – 6"	EG-147-15-TC

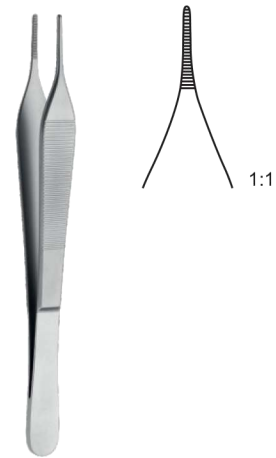

Micro-Adson

120 mm – 4 ¹ / ₄ "	EG-147-12-B
150 mm – 6"	EG-147-15-B



Adson-Graefe

120 mm – 4 ¹ / ₄ "	EG-147-12-A1
--	---------------------



Adson Brown

120 mm – 4 ¹ / ₄ "	EG-147-12-B1	EG-147-12-C1
120 mm – 4 ¹ / ₄ "	EG-147-12-B1-C	EG-147-12-C1-TC

Plastic Surgery

Dressing Forceps - Dissecting Forceps



Adson

120 mm – 4 1/4"	EG-148-12-A	EG-148-12-A1
150 mm – 6"	EG-148-15-A	EG-148-15-A1
120 mm – 4 1/4"	EG-148-12-A-TC	EG-148-12-A1-TC
150 mm – 6"	EG-148-15-A-TC	EG-148-15-A1-TC



EG-148-12-B	EG-148-12-B1
EG-148-15-B	EG-148-15-B1
EG-148-12-B-TC	EG-148-12-B1-TC
EG-148-15-B-TC	EG-148-15-B1-TC



Adson

120 mm – 4 1/4"
EG-148-13-A
mit Fadenplatte 1 mm with tying platfoEG 1 mm
avec platefoEGe pour sutures 1 mm con platafoEGa para suturas 1 mm con plattafoEGa per suture 1 mm



Ultra-Micro-Adson
(Braka)

120 mm – 4 1/4"
EG-148-13-B
mit Fadenplatte 1 mm with tying platfoEG 1 mm
avec platefoEGe pour sutures 1 mm con platafoEGa para suturas 1 mm con plattafoEGa per suture 1 mm

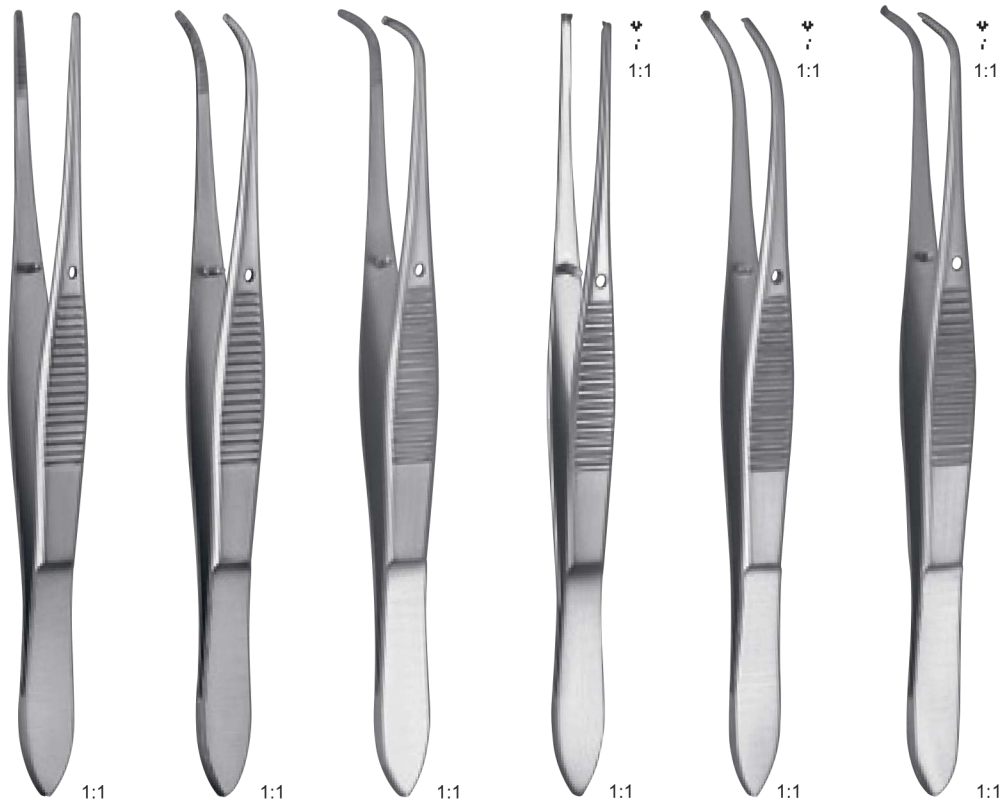

Graefe

105 mm – 4¹/₄"

EG-149-10-A

EG-149-10-B

EG-149-10-C

EG-149-10-D

EG-149-10-E

EG-149-10-F

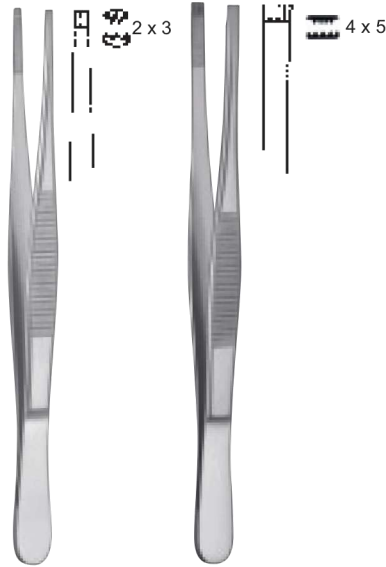

Adlerkreutz

150 mm – 6 "	EG-150-15-A	EG-150-15-B
200 mm – 8 "	EG-150-20-A	EG-150-20-B
250 mm – 9 ³ / ₄ "	EG-150-25-A	EG-150-25-B



Waugh

150 mm – 6 "	EG-150-15-C
200 mm – 8 "	EG-150-20-C
250 mm – 9 ³ / ₄ "	EG-150-25-C



Duehrssen

200 mm – 8 "

EG-150-20-A1



105 mm – 4¹/₄"

EG-150-10

Columella Pinzette

Columella forceps

Pince à columella

Pinza para columella

Pinze per columella



Potts-Smith

180 mm – 7 "	EG-151-18-A	EG-151-18-B
210 mm – 8 ¹ / ₄ "	EG-151-21-A	EG-151-21-B
250 mm – 9 ³ / ₄ "	EG-151-25-A	EG-151-25-B



Brophy

200 mm – 8 "	EG-151-20-A	EG-151-20-B
--------------	--------------------	--------------------

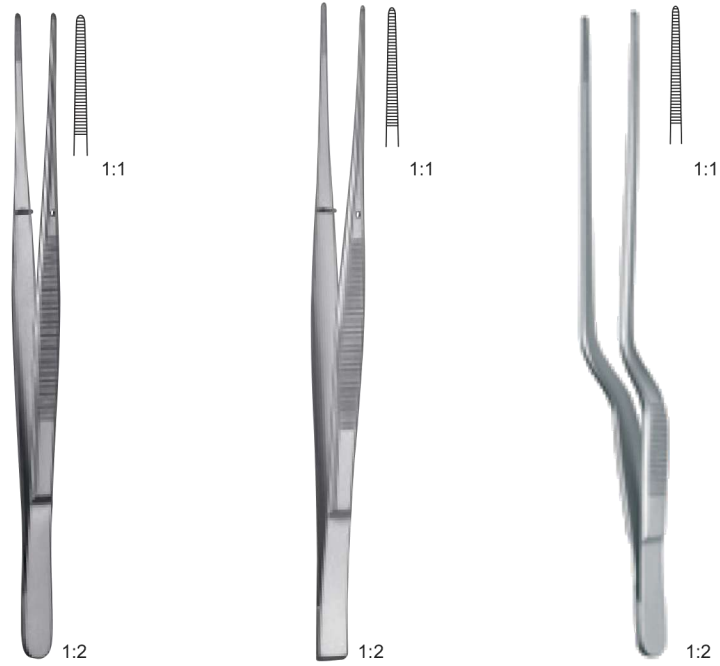

Taylor

175 mm – 7 "	EG-152-17-A	EG-152-17-B	EG-152-17-C
--------------	--------------------	--------------------	--------------------

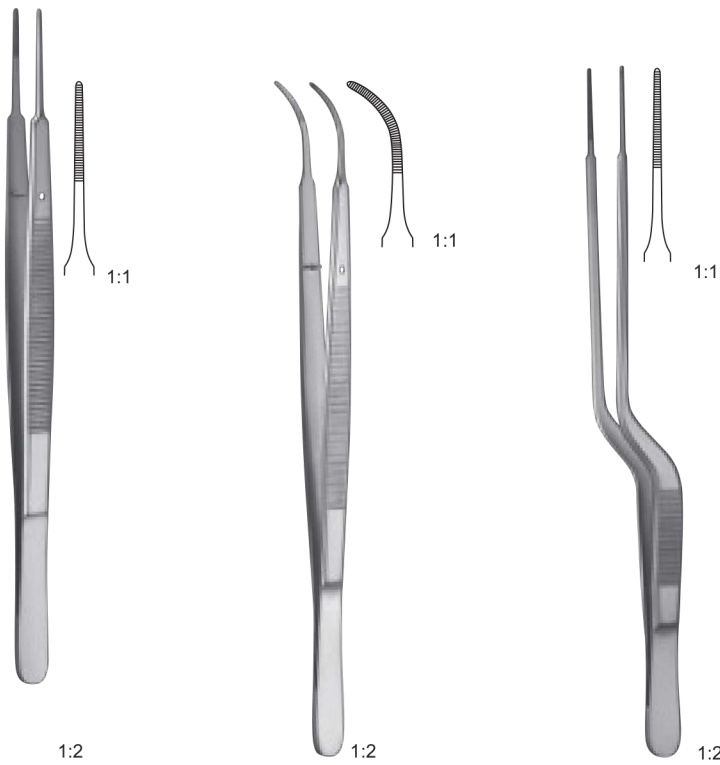

Gerald

180 mm – 7 "	EG-152-18-A	EG-152-18-B	EG-152-18-C
--------------	--------------------	--------------------	--------------------

Plastic Surgery

Atraumatic Tissue Forceps

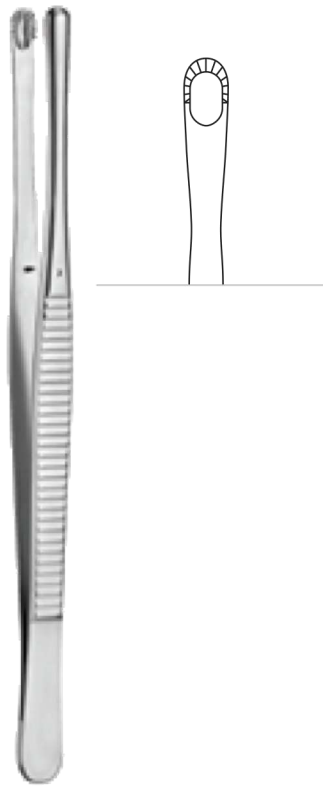

Russian Model

150 mm – 6 "	EG-153-15-A
--------------	--------------------



De Bakey-Gerald

150 mm – 6 "	EG-153-15-B
180 mm – 7 "	EG-153-18-A



De Bakey Bayonet

180 mm – 7 "	EG-153-18-B
200 mm – 8 "	EG-153-20

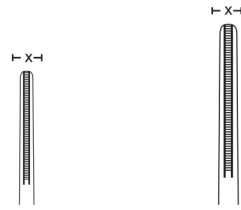

De Bakey

	x = 1.5mm	x = 2.0 mm
120 mm – 4 ³ / ₄ "	EG-154-12-A	EG-154-12-B
145 mm – 5 ³ / ₄ "	EG-154-14-A	EG-154-14-B
160 mm – 6 ¹ / ₄ "	EG-154-16-A	EG-154-16-B
200 mm – 8 "	EG-154-20-A	EG-154-20-B
240 mm – 9 ¹ / ₂ "	EG-154-24-A	EG-154-24-B
300 mm – 12 "	EG-154-30-A	EG-154-30-B

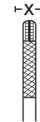
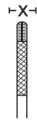

De Bakey

	x = 1.5 mm	x = 2.0 mm
150 mm – 6"	EG-155-15-A-TC	EG-155-15-B-TC
190 mm – 7½"	EG-155-19-A-TC	EG-155-19-B-TC
240 mm – 9½"	EG-155-24-A-TC	EG-155-24-B-TC

Micro Forceps



	x = 0.3mm	x = 0.5 mm
150 mm – 6 "	EG-156-15-A	EG-156-15-B
180 mm – 7 "	EG-156-18-A	EG-156-18-B

mit Fadenplatte
with tying platfoEG
 avec platefoEGe pour sutures
con platafoEGa para suturas
 con plattafoEGa per suture



	x = 0.3mm	x = 0.5 mm
150 mm – 6 "	EG-156-15-A1	EG-156-15-B1
180 mm – 7 "	EG-156-18-A1	EG-156-18-B1

mit Fadenplatte
with tying platfoEG
 avec platefoEGe pour sutures
con platafoEGa para suturas
 con plattafoEGa per suture



- x -

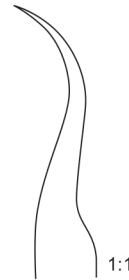
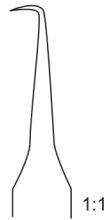
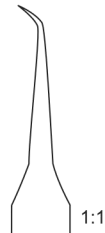

Typ
Juwelier

x = 0.2mm	x = 0.3mm	x = 0.3mm	x = 0.2mm	x = 0.3 mm
110 mm - 4 ₄ "	110mm - 4 ₄ "	110mm - 4 ₄ "	120mm - 4 ₄ "	120mm - 4 ₄ "
EG-157-11-A	EG-157-11-B	EG-157-11-C	EG-157-12-A	EG-157-12-B



Pierse

120 mm – 4 ¹ / ₄ "	EG-158-12
135 mm – 5 "	EG-158-13

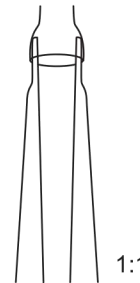
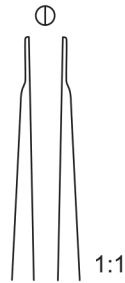

	x = 0.2mm	x = 0.3 mm
110 mm – 4 ₄ "	EG-159-11-A	EG-159-11-B

sehr fein
 very fine
 très fin
 muy fino
 molto fino

Plastic Surgery

Applying Forceps for Vessel Clips



140 mm – 5₂"

EG-160-14-A

EG-160-14-B

ohne Schloß
without lock

sans serrure
sin cierre

senza cremagliera

mit Schloß
with lock

avec serrure
con cierre

con cremagliera



140 mm – 5₂"

EG-160-14-C

für Approximatoren und Doppelklemmen
for approximators and double-clips

pour approximateurs et clips doubles
para aproximadores y clips dobles

per approssimatori e clips doppi



x	Ø	V	A
Länge	Gefäß	Vene	Arterie
<i>Length</i>	<i>Vessel</i>	<i>Vein</i>	<i>Artery</i>
Longueur	Vaisseau	Veine	Artère
<i>Longitud</i>	<i>Vaso</i>	<i>Vena</i>	<i>Arteria</i>
Lunghezza	Vaso	Vena	Arteria



50 x 25 x 4.5 mm 75 x 25 x 4.5 mm 70 x 45 x 8 mm

EG-160-10-A

EG-160-10-B

EG-160-10-C

Lagerungstrays für Gefäßclips
Trays for storage of vessel clips

Boîtes pour clips vasculaires
Cajas para clips vasculares

Scatole per clips vascolari

Approximators Clips

x = 8 mm



V	EG-161-08-A	EG-161-08-B	EG-161-08-C	EG-161-08-D
A	EG-161-08-A1	EG-161-08-B1	EG-161-08-C1	EG-161-08-D1

Ø = 0,4 mm - 1 mm

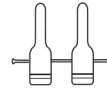
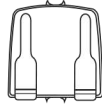

x = 11 mm

V	EG-161-11-A	EG-161-11-B	EG-161-11-C	EG-161-11-D
A	EG-161-11-A1	EG-161-11-B1	EG-161-11-C1	EG-161-11-D1

Ø = 0,6 mm - 1,5 mm

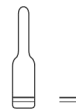
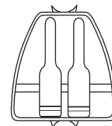
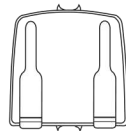

x = 14 mm

V	EG-161-14-A	EG-161-14-B	EG-161-14-C	EG-161-14-D
A	EG-161-14-A1	EG-161-14-B1	EG-161-14-C1	EG-161-14-D1

Ø = 1 mm - 2 mm

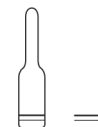
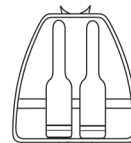
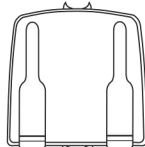

x = 17 mm

V	EG-161-17-A	EG-161-17-B	EG-161-17-C	EG-161-17-D
A	EG-161-17-A1	EG-161-17-B1	EG-161-17-C1	EG-161-17-D1

Ø = 1 mm - 2,25 mm

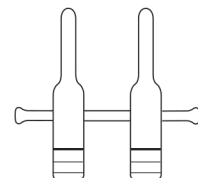
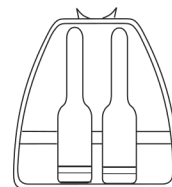
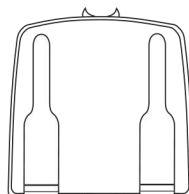

x = 25 mm

V	EG-161-25-A	EG-161-25-B	EG-161-25-C	EG-161-25-D
A	EG-161-25-A1	EG-161-25-B1	EG-161-25-C1	EG-161-25-D1

Ø = 1,5 mm - 3,5 mm

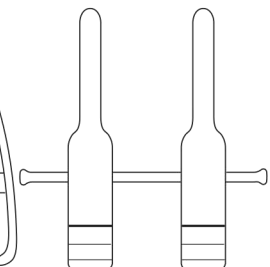
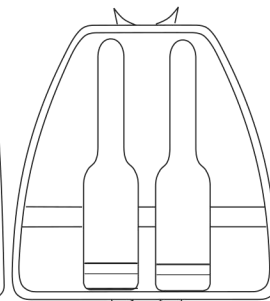
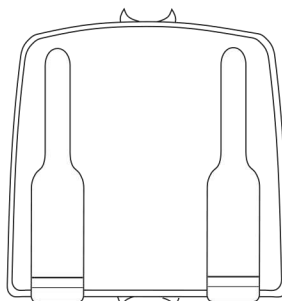

x = 36 mm

V	EG-161-36-A	EG-161-36-B	EG-161-36-C	EG-161-36-D
A	EG-161-36-A1	EG-161-36-B1	EG-161-36-C1	EG-161-36-D1

Ø = 1,5 mm - 3,5 mm

Plastic Surgery

Tissue and Intestinal Holding Forceps



Babcock

160 mm – 6 $\frac{1}{4}$ "	EG-163-16
180 mm – 7"	EG-163-18
200 mm – 8"	EG-163-20



Allis

150 mm – 6"	EG-163-15-A	EG-163-15-B
190 mm – 7 $\frac{1}{2}$ "	EG-163-19-A	EG-163-19-B

Zähne	4x5	5x6
Teeth		
Dents		
Dientes		
Denti		

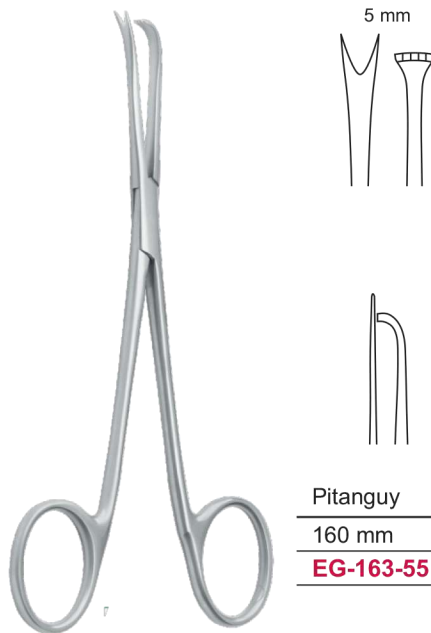

Pitanguy

160 mm
EG-163-55



Plastic Surgery

Haemostatic Forceps

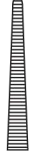
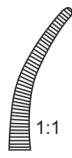

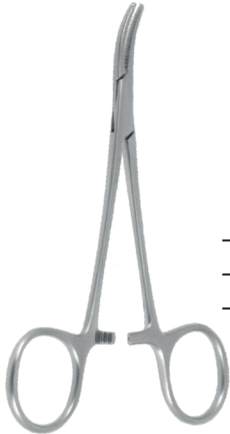

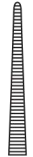
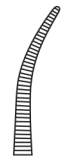

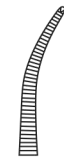
Hartmann	 1:1	 1:1
100 mm – 4 "	EG-164-10-A	EG-164-10-B



Micro-Mosquito	 1:1	 1:1	 1:1	 1:1
100 mm – 4 "	EG-164-10-A1	EG-164-10-B1	EG-164-10-C1	EG-164-10-D1
120 mm – 4 1/4 "	EG-164-12-A1	EG-164-12-B1	EG-164-12-C1	EG-164-12-D1
			1x2	1x2

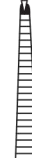

Halsted-Mosquito	 1:1	 1:1	 1:1	 1:1
125 mm – 5 "	EG-164-15-A1	EG-164-15-B1	EG-164-15-C1	EG-164-15-D1
140 mm – 5 1/2 "	EG-164-14-A1	EG-164-14-B1	EG-164-14-C1	EG-164-14-D1
			1x2	1x2

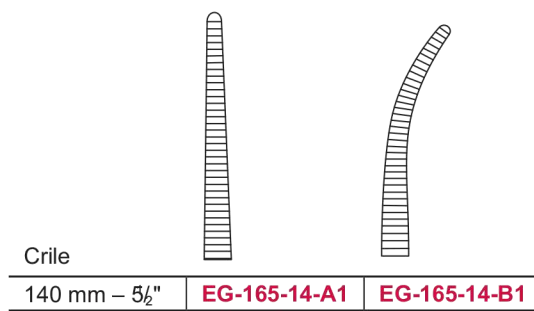
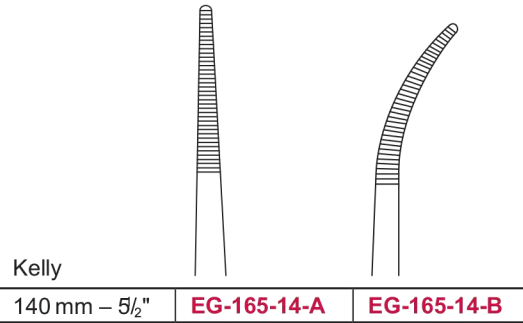

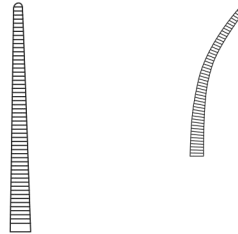

Péan

130 mm – 5 "	EG-166-13-A	EG-166-13-B
140 mm – 5½ "	EG-166-14-A	EG-166-14-B
160 mm – 6¼ "	EG-166-16-A	EG-166-16-B

graziles Modell
delicate pattern
 modèle délicat
modelo delicado
 modello delicato

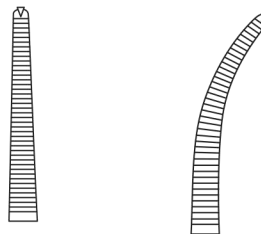

Kocher

130 mm – 5"	EG-166-13-A1	EG-166-13-B1
140 mm – 5½ "	EG-166-14-A1	EG-166-14-B1
160 mm – 6¼ "	EG-166-16-A1	EG-166-16-B1

graziles Modell
delicate pattern
 modèle délicat
modelo delicado
 modello delicato

1x2

1x2



Péan-Fino

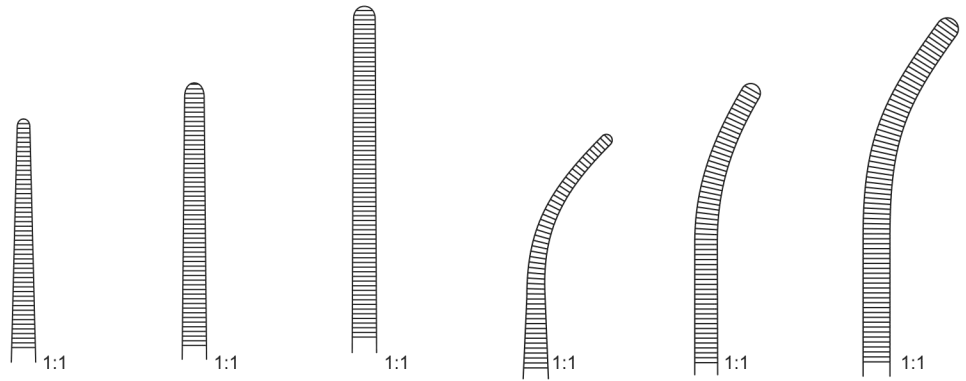

145 mm – 5 $\frac{1}{4}$ "	165mm – 6 $\frac{1}{2}$ "	185mm – 7 $\frac{1}{4}$ "	140mm – 5 $\frac{1}{2}$ "	160mm – 6 $\frac{1}{4}$ "	180mm – 7 "
EG-167-14-A	EG-167-16-A	EG-167-18-A	EG-167-40-A	EG-167-60-A	EG-167-80-A

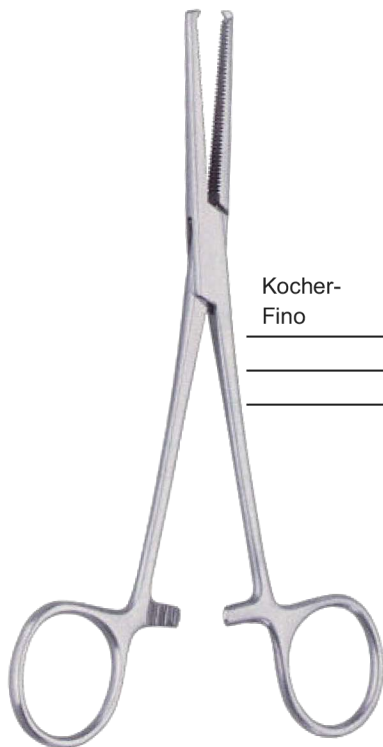

Kocher-Fino

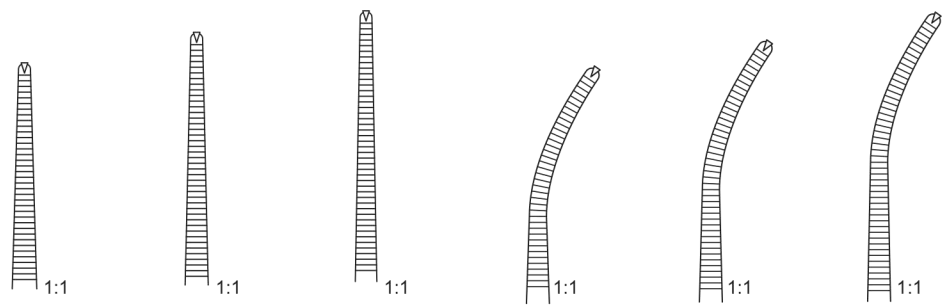



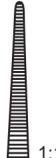
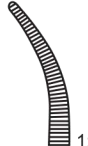

145 mm – 5 $\frac{1}{4}$ "	165mm – 6 $\frac{1}{2}$ "	185mm – 7 $\frac{1}{4}$ "	145mm – 5 $\frac{3}{4}$ "	160mm – 6 $\frac{1}{4}$ "	180mm – 7 "
EG-167-14-A1	EG-167-16-A1	EG-167-18-A1	EG-167-40-A1	EG-167-60-A1	EG-167-80-A1
1x2	1x2	1x2	1x2	1x2	1x2



			
	1:1	1:1	
Hartmann			
100 mm – 4 "	EG-168-10-A	EG-168-10-B	





1:2



				
Halsted-Mosquito				
125 mm – 5 "	EG-168-12-A	EG-168-12-B	EG-168-12-C	EG-168-12-D
140 mm – 5½"	EG-168-14-A	EG-168-14-B	EG-168-14-C	EG-168-14-D
			1x2	1x2

125 mm – 5 "	EG-168-12-A1	EG-168-12-B1	EG-168-12-C1	EG-168-12-D1
Titan			1x2	1x2
Titanium				
Titane				
Titano				
Titano				

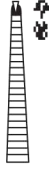

				
Micro-Mosquito				
100 mm – 4 "	EG-168-10-A1	EG-168-10-B1	EG-168-10-C1	EG-168-10-D1
120 mm – 4¾"	EG-168-12-A1	EG-168-12-B1	EG-168-12-C1	EG-168-12-D1



1:2

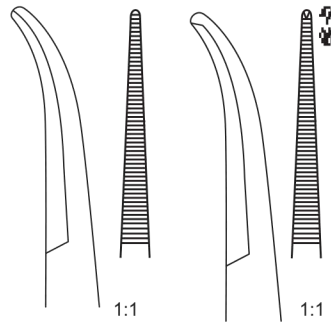

Dandy

140 mm – 5½"

EG-169-14-A

EG-169-14-B

seitlich gebogen
curved to the side
 courbe sur le plat
curva al lado
 curvata lateralmente



1:2

Mosquito-Dandy

EG-169-12

120 mm – 4¾"

seitlich gebogen
curved to the side
 courbe sur le plat
curva al lado
 curvata lateralmente



1:2

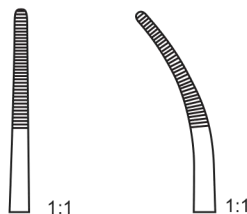

Providence-Hospital

140 mm – 5½"

EG-169-14-A1

EG-169-14-B1



Niro HM

EG-169-12-A

200 mm

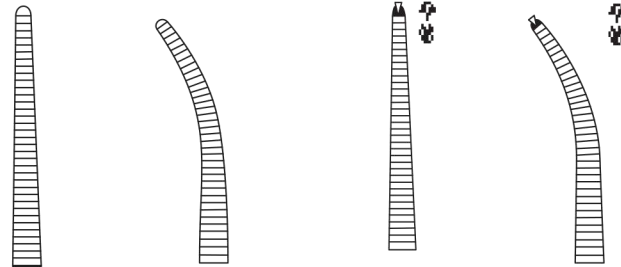

Crile

140 mm – 5 $\frac{1}{2}$ "	EG-170-14-A	EG-170-14-B	EG-170-14-C	EG-170-14-D
----------------------------	--------------------	--------------------	--------------------	--------------------

Crile-Rankin

160 mm – 6 $\frac{1}{4}$ "	EG-170-16-A	EG-170-16-B	EG-170-16-C	EG-170-16-D
----------------------------	--------------------	--------------------	--------------------	--------------------

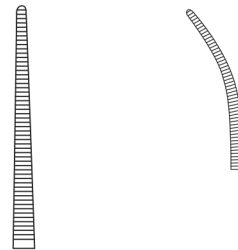

Péan

130 mm – 5"	EG-170-13-A	EG-170-13-B
140 mm – 5 $\frac{1}{2}$ "	EG-170-14-A1	EG-170-14-B1
160 mm – 6 $\frac{1}{4}$ "	EG-170-16-A1	EG-170-16-B1

graziles Modell
delicate pattern
 modèle délicat
modelo delicado
 modello delicato



1:2

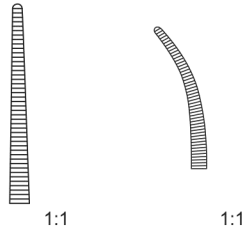

Leriche

150 mm – 6 "	EG-171-15-A	EG-171-15-B
--------------	--------------------	--------------------

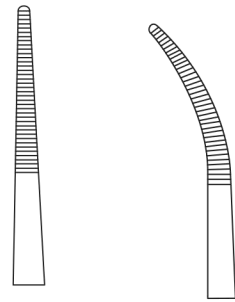

Kelly

140 mm – 5½"	EG-171-14-A	EG-171-14-B
--------------	--------------------	--------------------

Kelly-Rankin

160 mm – 6¼"	EG-171-16-A	EG-171-16-B
--------------	--------------------	--------------------

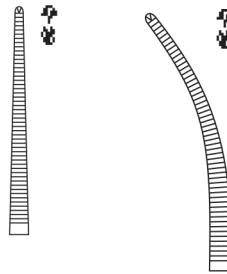

Kocher

130 mm – 5"	EG-172-13-A	EG-172-13-B
140 mm – 5½"	EG-172-14-A	EG-172-14-B
160 mm – 6¼"	EG-172-16-A	EG-172-16-B

graziles Modell
delicate pattern
 modèle délicat
modelo delicado
 modello delicato

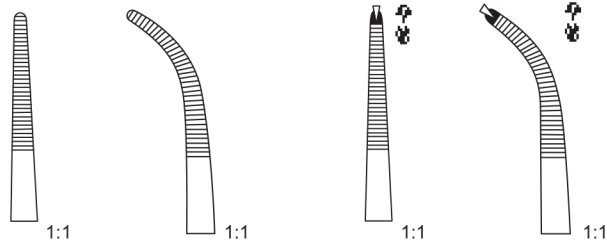

Adson

185 mm – 7¼"	EG-172-18-A	EG-172-18-B	EG-172-18-C	EG-172-18-D
--------------	--------------------	--------------------	--------------------	--------------------

Plastic Surgery

Haemostatic Forceps

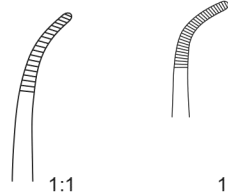
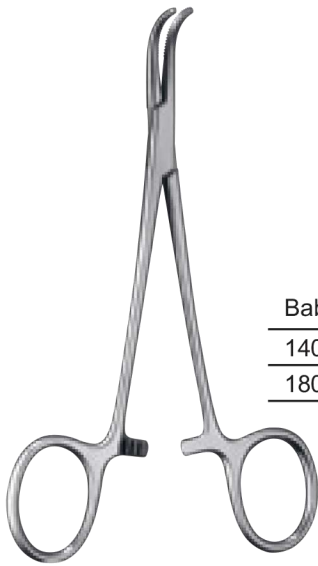

Baby-Mixer

140 mm – 5½"	EG-173-14-A	EG-173-14-B
180 mm – 7"	EG-173-18-A	EG-173-18-B

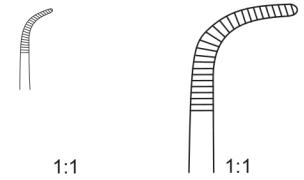
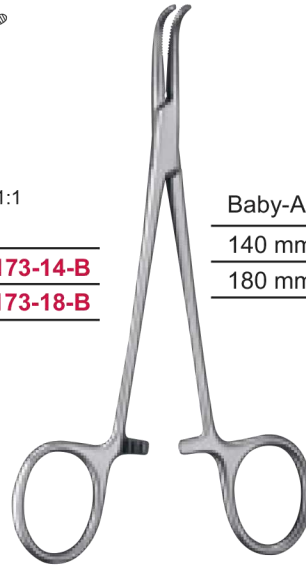

Baby-Adson

140 mm – 5½"	EG-173-14-A	EG-173-14-B
180 mm – 7"	EG-173-18-A	EG-173-18-B

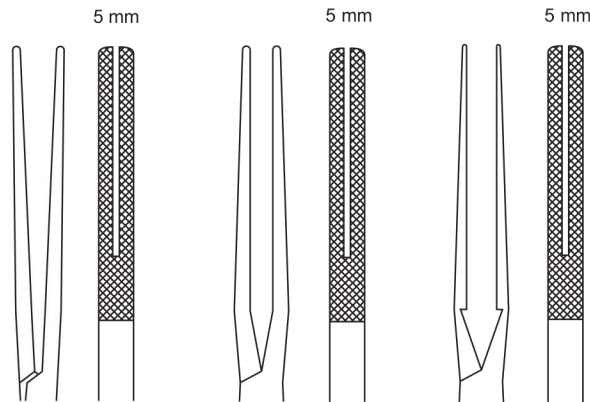

Aiach-Gubisch

160 mm - 6¼"	160 mm - 6¼"	160 mm - 6¼"
EG-173-16-A	EG-173-16-B	EG-173-16-C

fl exibel
fl exible
fl exible
fl exible
fl essibile



Forceps

EG-173-00

Plastic Surgery

Tissue and Intestinal Holding Forceps



Allis-Baby
 130 mm – 5"
EG-174-13
 4 x 5



Allis		
150 mm – 6"	EG-174-15-A	EG-174-15-B
190 mm – 7½"	EG-174-19-A	EG-174-19-B
250 mm – 9¾"	EG-174-25-A	EG-174-25-B

4 x 5 5 x 6



Allis-Adair
 155 mm – 6"
EG-174-55
 10 x 11



Thoms-Allis
 200 mm – 8"
EG-174-20-A
 6 x 7



Lockwood
 200 mm – 8"
EG-174-20-B



Williams
 160 mm – 6¼"
EG-174-16

Plastic Surgery

Cotton Swag Forceps -- Sponge Holding Forceps



Rampley

180 mm – 7 "	EG-175-18-A	EG-175-18-B
250 mm – 10 "	EG-175-25-A	EG-175-25-B

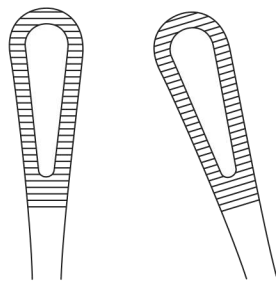

Kilner

18 mm
175 mm
EG-175-15-A

Kilner

200 mm
EG-175-15-B



Foers ter (Ball eng er)

180 mm – 7"	EG-175-18-A1	EG-175-18-B1	EG-175-18-C1	EG-175-18-D1
200 mm – 8"	EG-175-20-A	EG-175-20-B	EG-175-20-C	EG-175-20-D
250 mm – 10"	EG-175-25-A1	EG-175-25-B1	EG-175-25-C1	EG-175-25-D1

Plastic Surgery

Trachea and Nose Retractors



1:2
Kilner

150 mm – 6"
EG-176-15



1:2
Gillies

	Fig. 1	Fig. 2
180 mm – 7"	EG-176-18-A	EG-176-18-B



1:1



1:1



- | | | |
|--------|------------------|----------------------------------|
| 150 mm | EG-176-01 | Single Hook |
| 150 mm | EG-176-02 | 2 mm Single Hook |
| 150 mm | EG-176-03 | 5 mm Double Hook |
| 150 mm | EG-176-04 | 8 mm Double Hook |
| 150 mm | EG-176-05 | 11 mm Double Hook |
| 150 mm | EG-176-06 | 13 mm Double Hook with Ball Ends |

Tebbetts Self Retaining Skin Hook



1:2

Lange
220 mm – 8³/₄"
EG-176-22



1:2
Cottle

160 mm – 6¹/₄"
EG-176-16



1:2
Fomon

170 mm – 6³/₄"
EG-176-17



3 mm
Barsky
150 mm – 6"
EG-176-00

Plastic Surgery

Trachea and Nose Retractors



Cottle 1:2

150 mm – 6 "



1:1

EG-177-15-A



1:1

EG-177-15-B



1:1

EG-177-15-C



Joseph 1:2

150 mm – 6 "

EG-177-15-D



Mandibular

185 mm

EG-177-18-A



Joseph 1:2

160 mm – 6 1/4 "



2 mm

EG-177-16-A



5 mm

EG-177-16-B



7 mm

EG-177-16-C



10 mm

EG-177-16-D



Crile 1:2

200 mm – 8 "



1:1

Fig. 1

EG-177-20-A

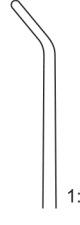

1:1

Fig. 2

EG-177-20-B

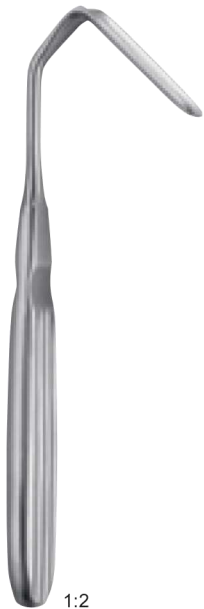

1:2
Aufricht
190 mm – 7½"
EG-178-19-A



1:2
Aufricht
190 mm – 7½"
EG-178-19-B



1:2
Converse
120 mm – 4"
EG-178-12



Aufricht
EG-178-13

Nasenhaken
Nasal hook
Crochet pour le nez
Gancho para la nariz
Uncino nasale

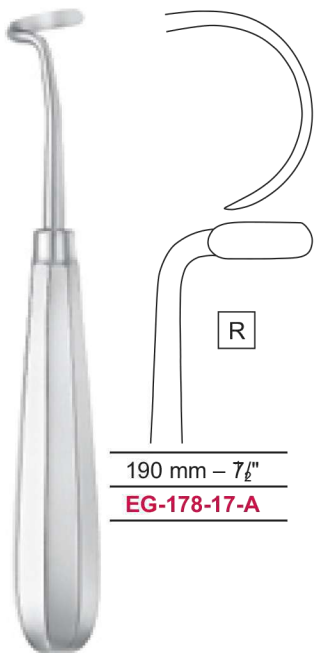

190 mm – 7½"
EG-178-17-A

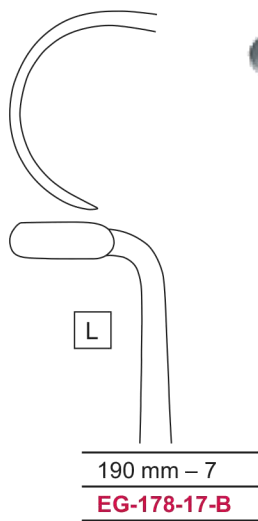

190 mm – 7"
EG-178-17-B



1/2"

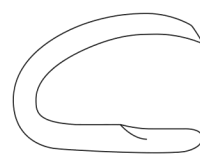

170 mm
EG-178-00-A

R

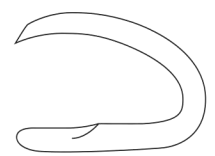

170 mm
EG-178-00-B

L

Plastic Surgery

Trachea and Nose Retractors

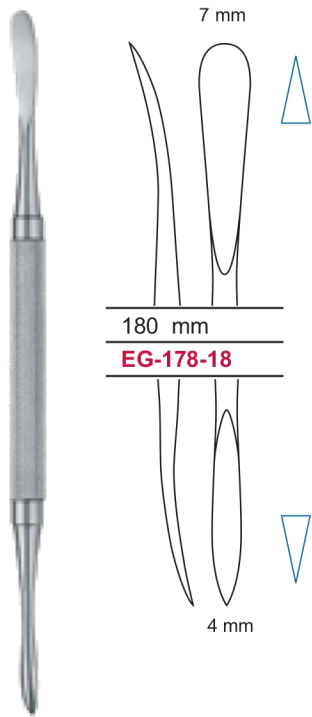

180 mm
EG-178-18

Dingman

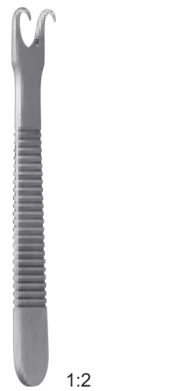

1:2
Kilner
100 mm – 4 "
EG-179-10



1:2
Martinez Kilner
110 mm – 4 1/4 "
EG-179-11
6 mm



1:2
Cottle
EG-179-12

Daumenhaken
Thumb hook
Crochet pour le doigt
Gancho para el dedo
Uncino da fi ssare sul pollice



Gillies	3 mm	5 mm
	190 mm	190 mm
	EG-179-01-A	EG-179-01-B

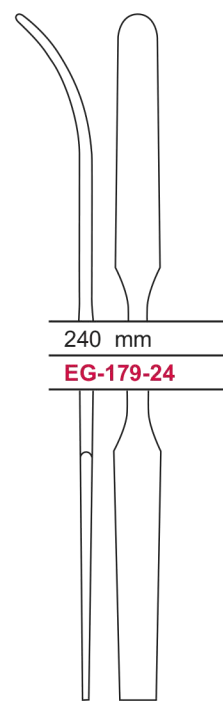

240 mm
EG-179-24

Cohen



130 mm
EG-179-13



C
Cottle-Neivert
200 mm – 8 "
EG-180-20



1:2
Fomon
160 mm – 6 1/4 "
EG-180-16-A



1:2
Cottle
150 mm – 6 1/4 "



1:1
EG-180-15-A



1:1
EG-180-15-B



1:1
EG-180-15-C

1:2



1:2
Neivert
160 mm – 6 1/4 "
EG-180-16-B



1:2
Cottle
150 mm – 6 " **EG-180-15-A1** **EG-180-15-B1**



1:2



1:2
Iterson
160 mm – 6 **EG-180-16-C** **EG-180-16-D**



1:1



1:1

Plastic Surgery

Trachea Retractors



1:2

Jackson

150 mm – 6"

EG-181-15



1:2

Lukens

170 mm – 6²/₃"

EG-181-17-A



1:2

Jackson

170 mm – 6²/₃"

EG-181-17-B



1,5 × 2 mm



2 × 3 mm



Guthre

130 mm – 5¹/₈"

EG-181-13-A

130 mm – 5¹/₈"

EG-181-13-B



1:2

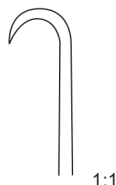

1:1



1:1

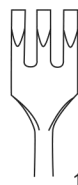

1:1

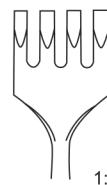

1:1

160 mm – 6¹/₄"

EG-181-16-A

EG-181-16-B

EG-181-16-C

EG-181-16-D

scharf

sharp

pointu

agudo

acuto

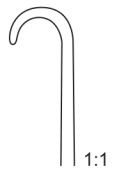

1:1

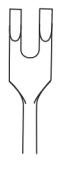

1:1



1:1

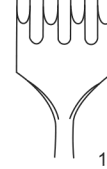

1:1

160 mm – 6¹/₄"

EG-181-16-A1

EG-181-16-B1

EG-181-16-C1

EG-181-16-D1

stumpf

blunt

mousse

romo



Daniel-Gubisch

215 mm

EG-181-21

Trachea Retractors



1:2



1:1



1:1

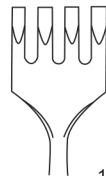

1:1

160 mm – 6 $\frac{1}{4}$ "	EG-182-16-A	EG-182-16-B	EG-182-16-C
----------------------------	--------------------	--------------------	--------------------

fl exibel, scharf
fl exible, sharp
 fl exible, pointu
fl exible, agudo
 fl essibile, acuto



1:1



1:1



1:1

160 mm – 6 $\frac{1}{4}$ "	EG-182-16-A1	EG-182-16-B1	EG-182-16-C1
----------------------------	---------------------	---------------------	---------------------

fl exibel, stumpf
fl exible, blunt
 fl exible, mousse
fl exible, romo
 fl essibile, smusso

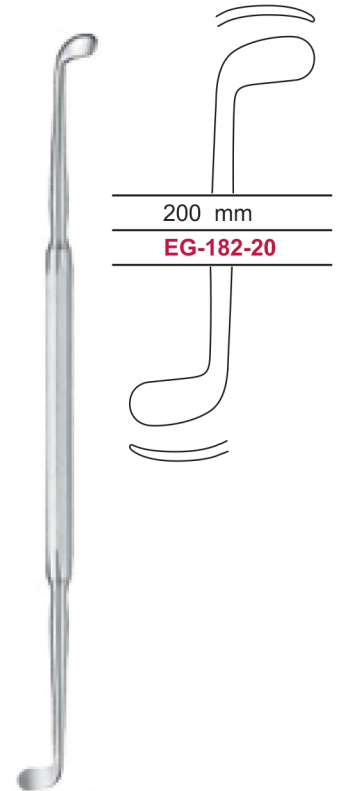

200 mm

EG-182-20

Pennington



1:1



1:2

(Rollet)
Knapp

160 mm – 6 $\frac{1}{4}$ "

EG-182-16-A0

fl exibel, scharf
fl exible, sharp



1:2

1:1



1:1



1:1



1:1

Desmarres

	x = 8 mm	x = 10 mm	x = 12 mm
160 mm – 6 $\frac{1}{4}$ "	EG-182-16-A2	EG-182-16-B2	EG-182-16-C2



1:1



1:1

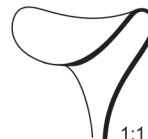

1:1

	x = 14 mm	x = 16 mm	x = 18 mm
160 mm – 6 $\frac{1}{4}$ "	EG-182-16-A3	EG-182-16-B3	EG-182-16-C3

Mamoplasty Retractors

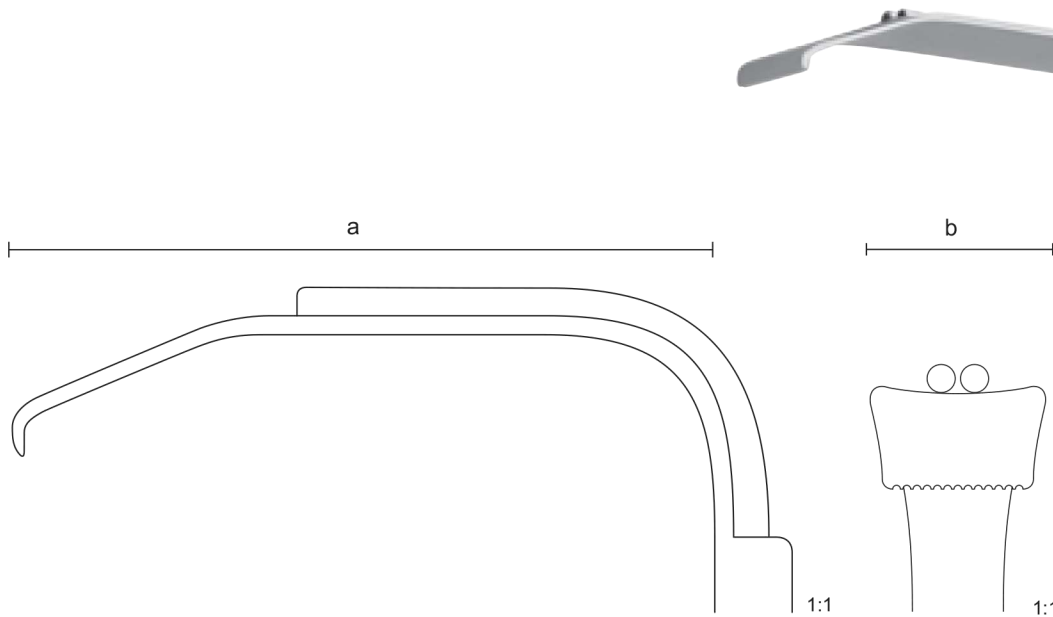

a	b	185 mm – 7 $\frac{1}{4}$ "	185 mm – 7 $\frac{1}{4}$ "
90 mm	24 mm	EG-183-09-A	EG-183-09-B
115 mm	24 mm	EG-183-11-A	EG-183-11-B
150 mm	25 mm	EG-183-25-A	EG-183-25-B
150 mm	36 mm	EG-183-36-A	EG-183-36-B
190 mm	30 mm	EG-183-19-A	EG-183-19-B

gezahnt und Kaltlichtbeleuchtung
toothed with fiber optic illumination

dentelée avec illumination à lumière froide
dentada con iluminación de luz fría
dentata con illuminazione a luce fredda

mit Spühlrohr
with irrigation tube

avec tube de lavage
con tubo lavador
con tubo di lavaggio

ohne Spühlrohr
without irrigation tube

sans tube de lavage
sin tubo lavador
senza tubo di lavaggio

a	b	185 mm – 7 $\frac{1}{4}$ "	185 mm – 7 $\frac{1}{4}$ "
90 mm	24 mm	EG-183-09-A1	EG-183-09-B1
115 mm	24 mm	EG-183-11-A1	EG-183-11-B1
150 mm	25 mm	EG-183-25-A1	EG-183-25-B1
150 mm	36 mm	EG-183-36-A1	EG-183-36-B1
190 mm	30 mm	EG-183-19-A1	EG-183-19-B1

ohne Zähne mit Kaltlichtbeleuchtung
non-toothed with fiber optic illumination

sans denture avec illumination à lumière froide
sin dentada con iluminación de luz fría
no dentata con illuminazione a luce fredda

mit Spühlrohr
with irrigation tube

avec tube de lavage
con tubo lavador
con tubo di lavaggio

ohne Spühlrohr
without irrigation tube

sans tube de lavage
sin tubo lavador
senza tubo di lavaggio





Mamaplasty Retractors

EG-184-00

Ferreira

a	b	185mm – 7 $\frac{1}{4}$ "	
90mm	24 mm	EG-184-09-A	EG-184-09-B
115mm	24 mm	EG-184-11-A	EG-184-11-B
150mm	25 mm	EG-184-25-A	EG-184-25-B
150 mm	36 mm	EG-184-15-A	EG-184-15-B
190mm	30 mm	EG-184-19-A	EG-184-19-B

MacCollum -
Dingman

315mm – 12 $\frac{1}{2}$ "

EG-184-31

1:2

Wundhaken
Retractors

Ecarteurs
Retractors

Divaricatori

ohne Zahnung
non- toothed

sans denture
sin dentada

no dentata

Gezahnt
toothed

denture
dentada

dentata

Mamaplasty Retractors



330 mm – 13 "	EG-185-33-A	EG-185-33-B	EG-185-33-C
420 mm – 16½ "	EG-185-42-A	EG-185-42-B	EG-185-42-C
abgewinkelt <i>angled</i>	starr <i>rigid</i>	biegsam <i>malleable</i>	Schaft isoliert <i>Shaft insulated</i>
angulé <i>angulado</i> angolato	rigide <i>rigido</i>	maléable <i>maleable</i> flessibile	Tige isolée <i>Tija aislada</i> Asta isolata









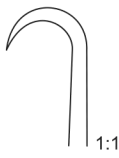

330 mm – 13 "	EG-185-33-A1	EG-185-33-B1	EG-185-33-C1
420 mm – 16½ "	EG-185-42-A1	EG-185-42-B1	EG-185-42-C1
	starr <i>rigid</i>	biegsam <i>malleable</i>	Schaftisoliert <i>Shaftinsulated</i>
	rigide <i>rigido</i>	maléable <i>maleable</i> flessibile	Tige isolée <i>Tija aislada</i> Asta isolata

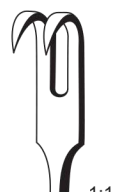

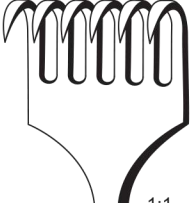
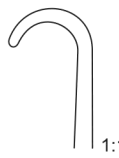
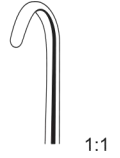
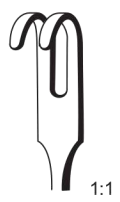
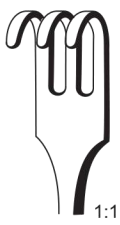

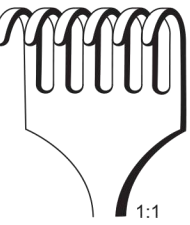

	x = 25mm	x = 33 mm
315mm – 12½ "	EG-185-31-A	EG-185-31-B
halbstarr <i>semi rigid</i>		
semi rigide <i>semi rigido</i>		



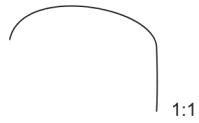

 1:1	 1:1	 1:1	 1:1	 1:1	 1:1
Volkmann					
215 mm – 8 $\frac{1}{2}$ "	EG-186-21-A	EG-186-21-B	EG-186-21-C	EG-186-21-D	EG-186-21-E
scharf sharp pointu agudo acuto					
 1:1	 1:1	 1:1	 1:1	 1:1	 1:1
215 mm – 8 $\frac{1}{2}$ "	EG-186-21-A1	EG-186-21-B1	EG-186-21-C1	EG-186-21-D1	EG-186-21-E1
stumpf blunt mousse romo smusso					



 1:1	 1:1	 1:1
Strandell-Stille		
190 mm – 7 $\frac{1}{2}$ "	EG-186-19-A	EG-186-19-B
	Fig. 1	Fig. 2
gezahnt saw edge dentelé dentado dentato		

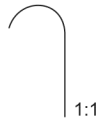

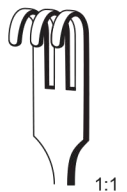
 1:1	 1:1	 1:1
Senn-Mueller		
160 mm – 6 $\frac{1}{4}$ "	EG-186-16-A	EG-186-16-B
	scharf sharp pointu agudo acuto	stumpf blunt mousse romo smusso

Plastic Surgery

Self-Retaining Retractors Wound Spreader



Meyerding		
	18 mm x 7 mm	10 mm x 3 mm
180 mm – 7 "	RM-187-18-A	RM-187-18-B

	16 mm x 5 mm	7 mm x 4 mm
180 mm – 7 "	RM-187-18-A1	RM-187-18-B1

	10 mm x 4 mm	7 mm x 4 mm
180 mm – 7 "	RM-187-18-A2	RM-187-18-B2

	8 mm x 4 mm
	Ragnell-Davis
	140 mm – 5 $\frac{1}{2}$ "
	RM-187-14
	15 mm x 5,5 mm



Alm			
	4 x 4	4 x 4	4 x 4
70 mm – 2 $\frac{3}{4}$ "	RM-187-07-A	RM-187-07-B	RM-187-07-C
100 mm – 4 "	RM-187-10-A	RM-187-10-B	RM-187-10-C
	scharf sharp	halbscharf semi sharp	stumpf blunt
	pointu agudo	semi pointu semi agudo	mousse romo
	acuto	semi acuto	smusso

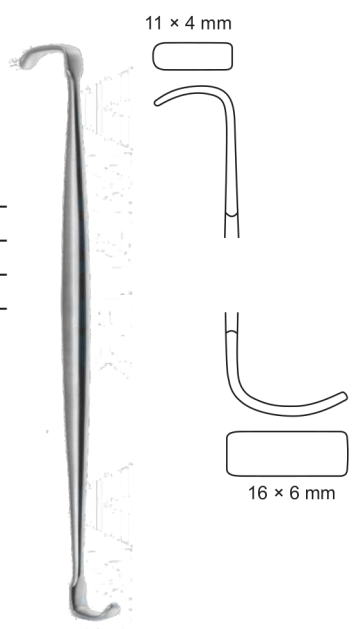

	11 x 4 mm
	160 mm – 6 $\frac{1}{2}$ "
	RM-187-16



Holtzheimer	
	4 x 4
100 mm – 4 "	RM-187-10-A1 RM-187-10-B1
	scharf sharp
	stumpf blunt
	pointu agudo
	mousse romo
	acuto smusso

Retractors



Freeman

	x = 22 mm
100 mm – 4 "	EG-188-10-A

scharf
sharp
pointu
agudo
acuto



Freeman

	x = 38 mm
100 mm – 4 "	EG-188-10-B

scharf
sharp
pointu
agudo
acuto



Gorney

	x = 38 mm
75 mm – 3 "	EG-188-07

scharf
sharp
pointu
agudo
acuto

Retractors



1:2

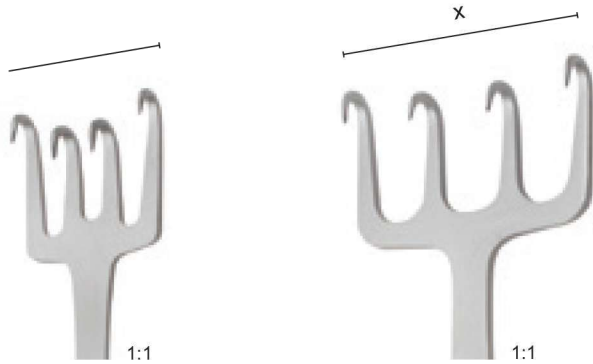

1:1

1:1

Freeman

	x = 22mm	x = 38 mm
180 mm - 7"	EG-189-18-A	EG-189-18-B

scharf
sharp
pointu
agudo
acuto

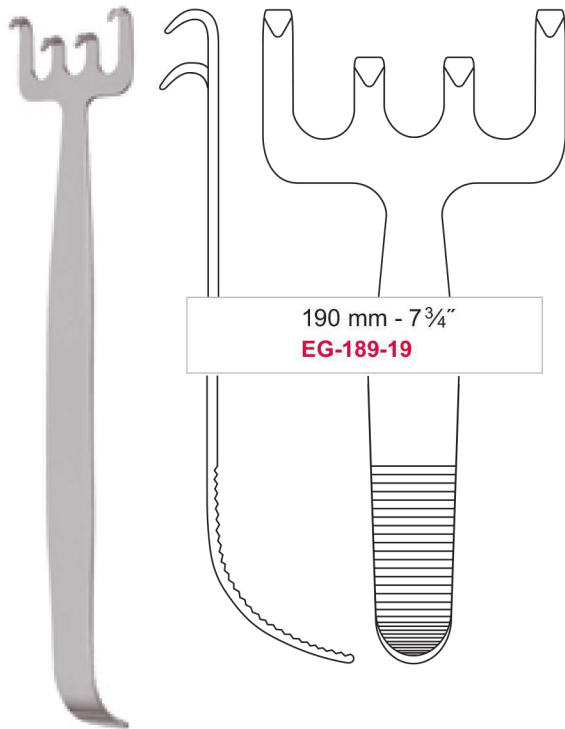

190 mm - 7 3/4"
EG-189-19

Walter



1:2

Yancoskie

	x = 150 mm
180 mm – 7 "	EG-190-18-A

scharf
sharp
pointu
agudo
acuto



Farabeuf-Baby

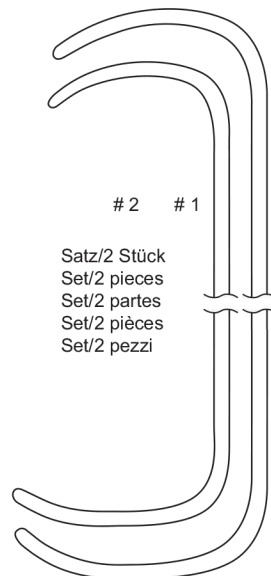

2 # 1
Satz/2 Stück
Set/2 pieces
Set/2 partes
Set/2 pièces
Set/2 pezzi

acuto

B = 17 × 32 mm	
# 1	# 2
A = 10 × 25 mm	A = 10 × 30 mm
	B = 17 × 35 mm
120 mm	
EG-190-18-C	



1:2

Coronal lift

	x = 70 mm
180 mm – 7 "	EG-190-18-B

scharf
sharp
pointu
agudo

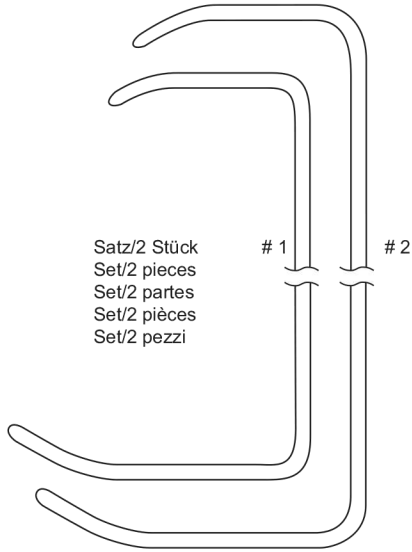

Satz/2 Stück
Set/2 pieces
Set/2 partes
Set/2 pièces
Set/2 pezzi

1

2

# 1	# 2
A = 15 × 23 mm	A = 15 × 28 mm
B = 15 × 37 mm	B = 15 × 40 mm
210 mm	
EG-190A-18-A	

Parker-Langenbeck

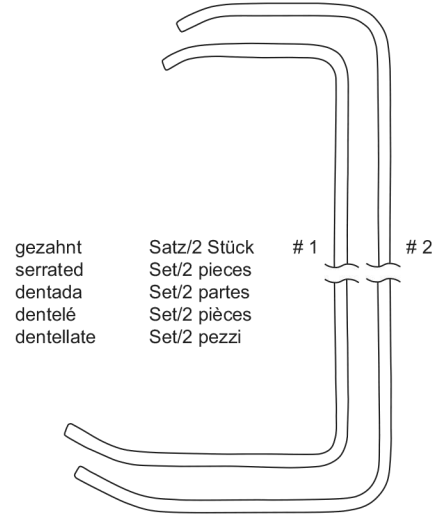

gezahnt
serrated
dentada
dentelée
dentellate

Satz/2 Stück
Set/2 pieces
Set/2 partes
Set/2 pièces
Set/2 pezzi

1

2

# 1	# 2
A = 15 × 24 mm	A = 15 × 28 mm
B = 15 × 36 mm	B = 15 × 40 mm
210 mm	
EG-190A-18-B	

Parker-Langenbeck



175 mm

EG-190A-17-A

Daniel-Gubisch

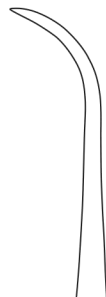

175 mm

EG-190A-17-B

Daniel-Gubisch

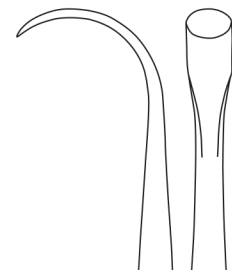

160 mm

EG-190A-17-C

Daniel-Gubisch

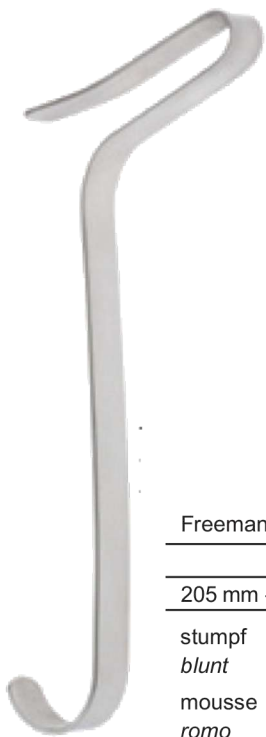

Freeman

1:2



1:1



1:1

	x = 12mm	x = 25 mm
205 mm – 8"	EG-191-20-A	EG-191-20-B

stumpf
blunt
mousse
romo
smusso



1:2

Ferreira

	x = 23 mm / y = 120 mm
100 mm – 4"	EG-191-10

stumpf
blunt
mousse
romo
smusso

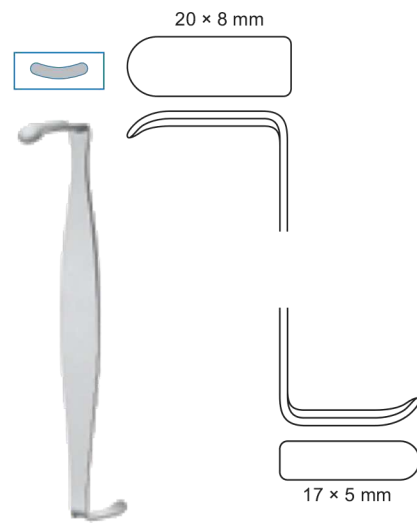

Coronal lift

	x = 70 mm
11 cm – 4 3/8"	EG-191-11

scharf
sharp
pointu
agudo
acuto

Plastic Surgery

Soft Tissue Retractors for Maxillo Facial Surgery

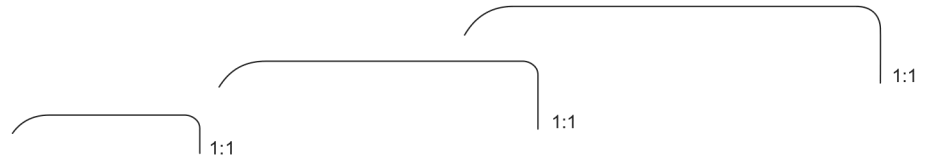

Obwegeser

	7 mm x 25 mm	10 mm x 42 mm	12 mm x 55 mm
215 mm – 8 ¹ / ₂ "	EG-192-21-A	EG-192-21-B	EG-192-21-C



1:3

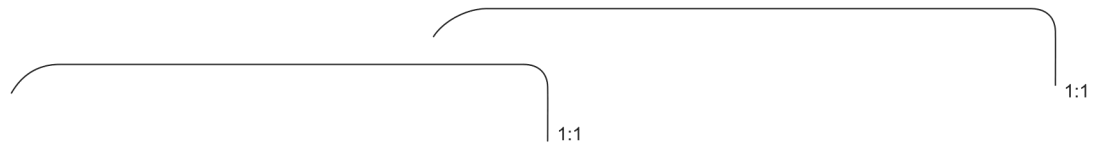

	14 mm x 70 mm	16 mm x 80 mm
215 mm – 8 ¹ / ₂ "	EG-192-21-D	EG-192-21-E

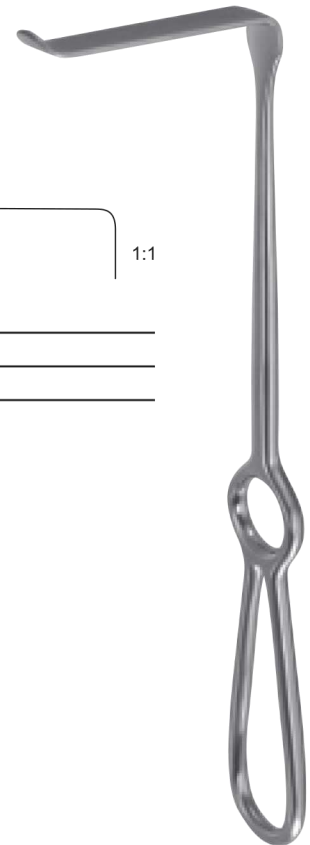

1:2



Obwegeser

	13 mm x 42 mm	12 mm x 60 mm
220 mm – 8 ³ / ₄ "	EG-192-22-A	EG-192-22-B



	16 mm x 80 mm
220 mm – 8 ³ / ₄ "	EG-192-22-C

Plastic Surgery

Soft Tissue Retractors for Maxillo

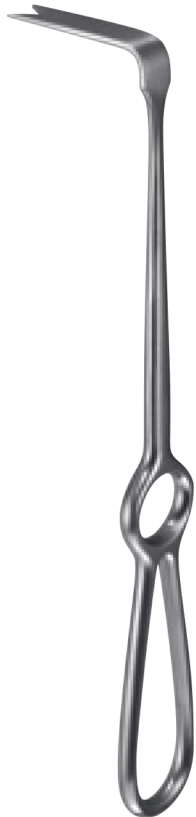

1:2

Obwegeser

	44 mm x 9,5 mm	70 mm x 11,5 mm
220 mm – 8 1/2"	EG-193-22-A	EG-193-22-B

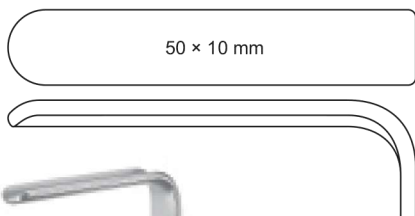

50 x 10 mm



Aufricht Daniel

110 mm – 6"

EG-193-11



1:2

Obwegeser

155 mm – 6"

EG-193-15



1:2

Obwegeser

	8 mm	10 mm
	EG-193-16-A	EG-193-16-B

biegsam
160 mm – 6 1/4"
malleable
malléable
flexible
fl essible

Plastic Surgery

Retractors Wound Spreader Self-Retaining



1:2

Weitlaner-Loktite

105 mm – 4 ¼"	EG-194-10-A	EG-194-10-B	EG-194-10-C
	scharf	halbscharf	stumpf
	sharp	semi sharp	blunt
	pointu	semi pointu	mousse
	agudo	semi agudo	romo
	acuto	semi acuto	smusso



Weitlaner-Loktite

130 mm – 5 "	EG-194-13-A	EG-194-13-B	EG-194-13-C
130 mm – 5 "	EG-194-13-A	EG-194-13-B	EG-194-13-C
165 mm – 6 ½"	EG-194-16-A	EG-194-16-B	EG-194-16-C
200 mm – 8 "	EG-194-20-A	EG-194-20-B	EG-194-20-C
260 mm – 10 ¼"	EG-194-26-A	EG-194-26-B	EG-194-26-C
	scharf	halbscharf	stumpf
	sharp	semi sharp	blunt
	pointu	semi pointu	mousse
	agudo	semi agudo	romo
	acuto	semi acuto	smusso

Plastic Surgery

Retractors Wound Spreader Self-Retaining



Wullstein

100 mm – 4 "	EG-195-10-A	EG-195-10-B
--------------	--------------------	--------------------

Belucci

110 mm – 4 1/4 "	EG-195-11-A	EG-195-11-B
130 mm – 5 "	EG-195-13-A	EG-195-13-B



links, stumpf
left, blunt
gauche, mousse
izquierda, romo
sinistra, smusso

rechts, stumpf
right, blunt
droit, mousse
derecha, romo
destra, smusso



Miligan

130 mm – 5 "	EG-195-13-A1
--------------	---------------------

stumpf
blunt
mousse
romo
smusso



Travers

205 mm – 8 1/2 "	EG-195-20
------------------	------------------

stumpf
blunt
mousse
romo
smusso

Plastic Surgery

Needle Holder



Derf
125 mm – 5"
EG-197-12



Gubisch
125 mm – 5"
EG-197-13



Crile-Murray
150 mm – 6"
EG-197-15



Crile-Wood		
150 mm – 6"	EG-197-15-A	EG-197-15-TC
180 mm – 7"	EG-197-18	EG-197-18-TC
200 mm – 8"	EG-197-20	EG-197-20-TC

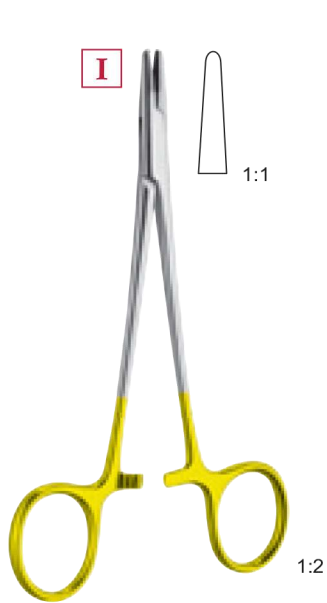

Hegar-Baumgartner

140 mm – 5 $\frac{1}{4}$ "	EG-198-14
140 mm – 5 $\frac{1}{4}$ "	EG-198-14-TC



Baby-Crile-Wood

150 mm – 6"	EG-198-15-TC
	EG-198-15

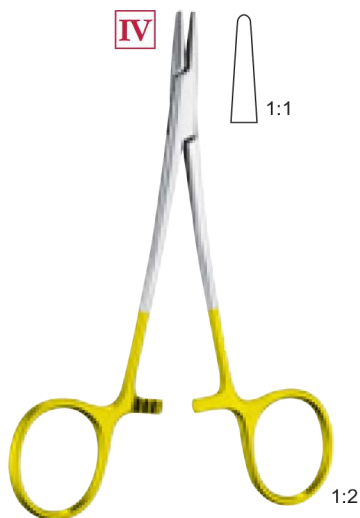

Webster

130 mm – 5"	EG-198-13
130 mm – 5"	EG-198-13-TC

glatt
smooth
lisse
liso
liscio



Mathieu-Olsen

140 mm – 5 $\frac{1}{2}$ "	EG-198-14-A	EG-198-14-A-TC
170 mm – 6 $\frac{1}{4}$ "	EG-198-17	EG-198-17-TC
200 mm – 8"	EG-198-20	EG-198-20-TC

Plastic Surgery

Needle Holder



1:2

IV



1:1

II



1:1

Halsey

130 mm – 5"	EG-199-13-A	EG-199-13-B
130 mm – 5"	EG-199-13-A-TC	EG-199-13-B-TC

glatt
smooth

lisse
liso
liscio

gerieft
serrated

strié
estriada
zigrinato



Methieu HM

140 mm	EG-199-14A-TC
170 mm	EG-199-17A-TC
200 mm	EG-199-20A-TC
240 mm	EG-199-24A-TC



II



1:2



1:2

Olsen-Hegar

120 mm – 4 ₄ "	EG-199-12	EG-199-12-TC
140 mm – 5 ₂	EG-199-14	EG-199-14-TC
170 mm – 6 ₄	EG-199-17	EG-199-17-TC
190 mm – 7 ₂	EG-199-19	EG-199-19-TC

Needle Holder

I

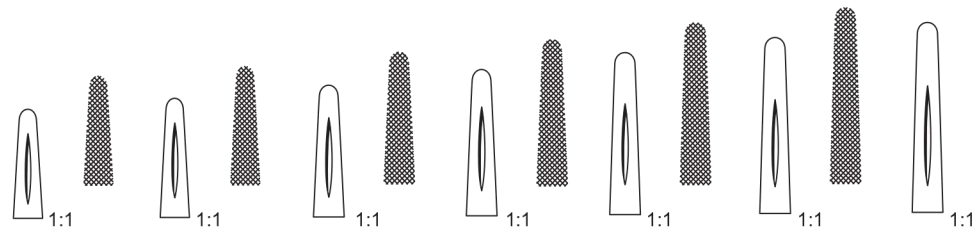

Mayo-Hegar

140 mm – 5 1/2"	160 mm – 6 1/4"	180 mm – 7"	200 mm – 8"	240 mm – 9 1/2"	260 mm – 10 1/4"	300 mm – 12"
RM-1100-14	RM-1100-16	RM-1100-18	RM-1100-20	RM-1100-24	RM-1100-26	RM-1100-30

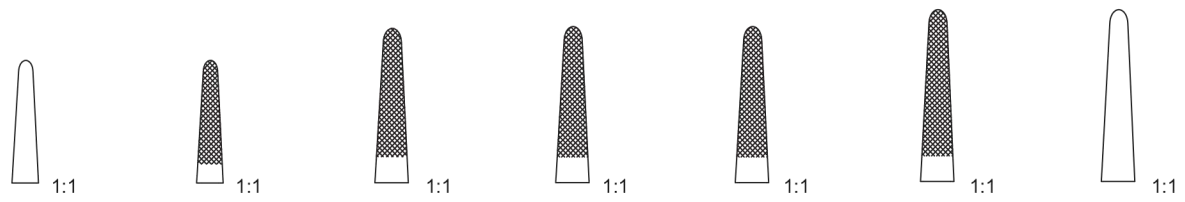

Mayo-Hegar

140 mm – 5 1/2"	160 mm – 6 1/4"	180 mm – 7"	200 mm – 8"	240 mm – 9 1/2"	260 mm – 10 1/4"	300 mm – 12"
RM-1100-14-A-TC	RM-1100-16-A-TC	RM-1100-18-A-TC	RM-1100-20-A-TC	RM-1100-24-A-TC	RM-1100-26-A-TC	RM-1100-30-A-TC

Needle Holder

II

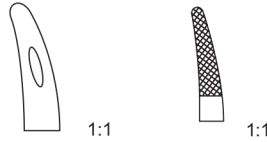

Gillies

160 mm – 6 $\frac{1}{4}$ "	EG-1101-16-A	EG-1101-16-B
----------------------------	---------------------	---------------------



Gillies

145 mm – 5 $\frac{3}{4}$ "	EG-1101-14-A	EG-1101-14-B
----------------------------	---------------------	---------------------



Foster-Gillies

120 mm – 4 $\frac{1}{4}$ "	EG-1101-12-A	EG-1101-12-B	EG-1101-12-C	EG-1101-12-D
----------------------------	---------------------	---------------------	---------------------	---------------------



gerade, gerieft
straight, serrated
droit, strié
recta, estriada
retto, zigrinato

gerade, glatt
straight, smooth
droit, lisse
recta, lisa
retto, liscio

gebogen, gerieft
curved, serrated
courbe, strié
curva, estriada
curvo, zigrinato

gebogen, glatt
curved, smooth
courbe, lisse
curva, lisa
curvo, liscio

Plastic Surgery

Needle Holder

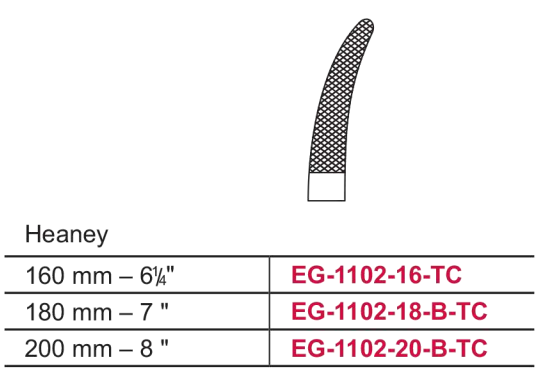
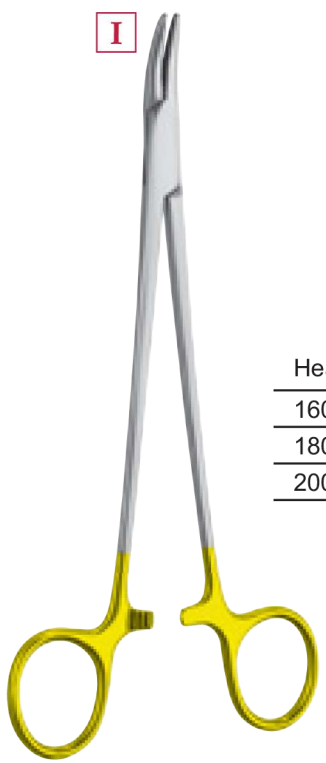
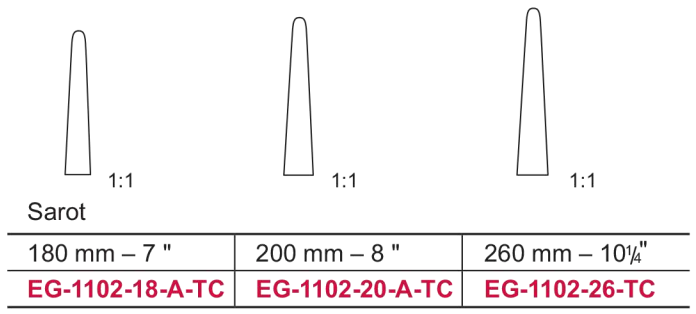
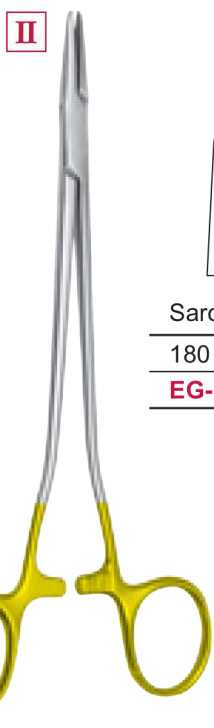
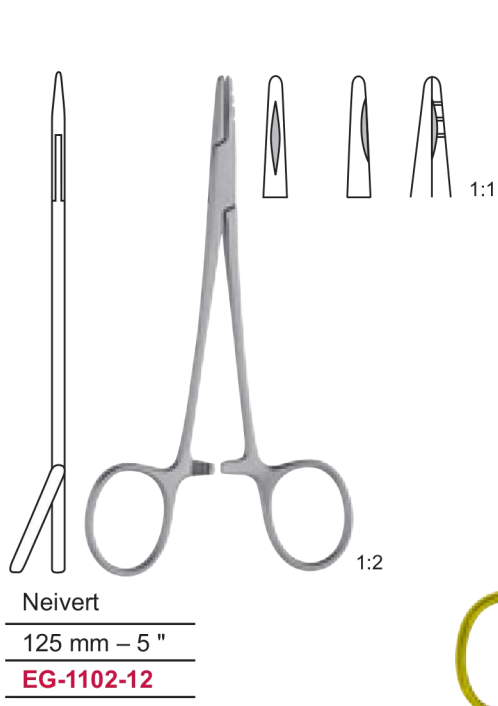

Plastic Surgery

Needle Holder

II

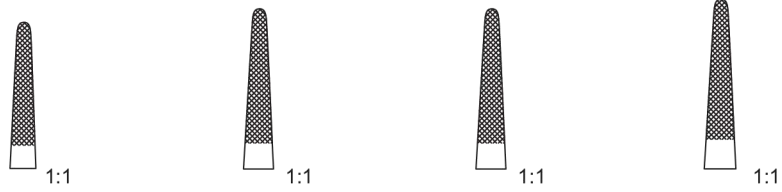
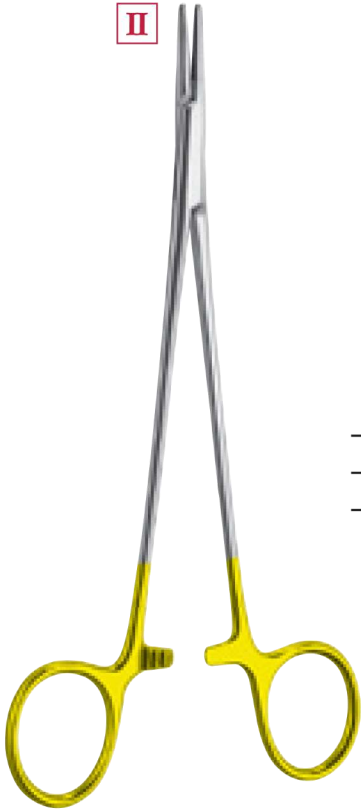

De Bakey

180 mm – 7 "	200 mm – 8 "	230 mm – 9 "	260 mm – 10 ₄ "
EG-1103-18-A-TC	EG-1103-20-A-TC	EG-1103-23-A-TC	EG-1103-26-TC

III

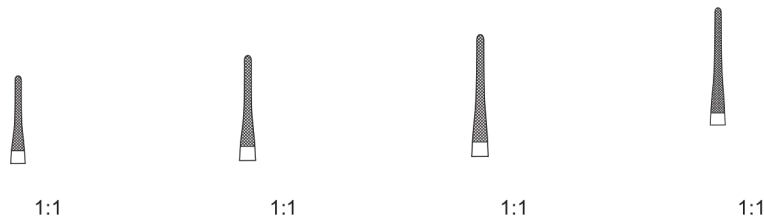

Vascular

140 mm – 5 ₂ "	180 mm – 7 "	200 mm – 8 "	230 mm – 9 "
EG-1103-14-TC	EG-1103-18-B-TC	EG-1103-20-B-TC	EG-1103-23-B-TC

Plastic Surgery

Needle Holder



1:1



1:1



1:1

130 mm – 5 "	150 mm – 5 ³ / ₄ "	170 mm – 6 ³ / ₄ "
EG-1104-13	EG-1104-15	EG-1104-17

mit Spezialbeschichtung im Maul
with special coated jaw
 mors avec couche special
boca con capa especial
 morso "diamant dust"



1:1



1:1



1:1

180 mm – 7 "	200 mm – 8 "	230 mm – 9 "
EG-1104-18	EG-1104-20	EG-1104-23

mit Spezialbeschichtung im Maul
with special coated jaw
 mors avec couche special
boca con capa especial
 morso "diamant dust"



Nagata HM	
115 mm	130 mm
EG-1104-11	EG-1104-13-A

II



Lichtenberg

170 mm – 6 $\frac{1}{4}$ "	EG-1105-17-TC		EG-1105-17
200 mm – 8"		EG-1105-20-TC	EG-1105-20

III



Diethrich

160 mm – 6 $\frac{1}{4}$ "	EG-1105-16-TC
180 mm – 7"	EG-1105-16-A-TC
200 mm – 8"	EG-1105-20-A-TC
230 mm – 9"	EG-1105-23-TC
250 mm – 9 $\frac{1}{4}$ "	EG-1105-25-TC

II



III



Ryder

130 mm – 5"	EG-1105-13-A-TC	EG-1105-13-B-TC	EG-1105-13-C-TC
150 mm – 6"	EG-1105-15-A-TC	EG-1105-15-B-TC	EG-1105-15-C-TC
180 mm – 7"	EG-1105-18-A1-TC	EG-1105-18-B1-TC	EG-1105-18-C1-TC
200 mm – 8"	EG-1105-20-A1-TC	EG-1105-20-B1-TC	EG-1105-20-C1-TC
230 mm – 9"	EG-1105-23-A-TC	EG-1105-23-B-TC	EG-1105-23-E-TC
260 mm – 10 $\frac{1}{4}$ "	EG-1105-26-A-TC	EG-1105-26-B-TC	EG-1105-26-F-TC

Mini-Ryder



mit Spezialbeschichtung im Maul
with special coated jaw

Mors avec couche special
Boca con capa especial
Morso "diamant dust"



Best Quality Steel as required by our reliable and valued customers. Our skilled craftsman give life to the metal and give it the shape that will go through series of complicated process. The measurement and shape are checked according to sample. All instruments are inspected for every process they have been gone through.

Needle Holder

IV



Castroviejo-
Jacobson



140 mm – 5 ₂ "	EG-1106-14-A	EG-1106-14-A-TC	EG-1106-14-B	EG-1106-14-B-TC
150 mm – 6"	EG-1106-15-A	EG-1106-15-A-TC	EG-1106-15-B	EG-1106-15-B-TC
180 mm – 7"	EG-1106-18-A	EG-1106-18-A-TC	EG-1106-18-B	EG-1106-18-B-TC
210 mm – 8 ₄ "	EG-1106-21-A	EG-1106-21-A-TC	EG-1106-21-B	EG-1106-21-B-TC

glattes Maul
smooth jaws
mors lisse
boca lisa
morso liscio

gerade, ohne Sperre
straight, without ratchet
droit, sans crémaillère
recta, sin cremallera
retto, senza cremagliera

gerade, mit Sperre
straight, with ratchet
droit, avec crémaillère
recta, con cremallera
retto, con cremagliera



140 mm – 5 ₂ "	EG-1106-14-A1	EG-1106-14-A1-TC	EG-1106-14-B1	EG-1106-14-B1-TC
150 mm – 6"	EG-1106-15-A1	EG-1106-15-A1-TC	EG-1106-15-B1	EG-1106-15-B1-TC
180 mm – 7"	EG-1106-18-A1	EG-1106-18-A1-TC	EG-1106-18-B1	EG-1106-18-B1-TC
210 mm – 8 ₄ "	EG-1106-21-A1	EG-1106-21-A1-TC	EG-1106-21-B1	EG-1106-21-B1-TC

glattes Maul
smooth jaws
mors lisse
boca lisa
morso liscio

gebogen, ohne Sperre
curved, without ratchet
courbe, sans crémaillère
curva, sin cremallera
curvo, senza cremagliera

gebogen, mit Sperre
curved, with ratchet
courbe, avec crémaillère
curva, con cremallera
curvo, con cremagliera



1:2

Barraquer



1:1



1:1

145 mm – 5 ₄ "	EG-1106-14-A2	EG-1106-14-B2
---------------------------	----------------------	----------------------

gerade
straight
droit
recta
retto

gebogen
curved
courbe
curva
curvo

Plastic Surgery

Micro Blade Holder --- Micro Blades



Castroviejo

x = 11.0 mm x 0.75 mm				
140 mm - 5 1/2"	EG-1107-14-A	EG-1107-14-B	EG-1107-14-C	EG-1107-14-D
ohne Sperre, feines Maul <i>without ratchet, fine jaws</i>	gerade <i>straight</i>	gebogen <i>curved</i>	gerade, diamantiert <i>straight, diamond coated</i>	gebogen, diamantiert <i>curved, diamond coated</i>
sans crémaillère, mors fine <i>sin cremallera, boca fina</i>	droit <i>recta</i>	courbe <i>curva</i>	droit, diamanté <i>recta, diamantada</i>	courbe, diamanté <i>curva, diamantada</i>
senza cremagliera, morso fino	retto	curvo	retto, diamantato	curvo, diamantato



1:1

x = 11.0 mm x 0.75 mm				
140 mm - 5 1/2"	EG-1107-14-A1	EG-1107-14-B1	EG-1107-14-C1	EG-1107-14-D1
mit Sperre, feines Maul <i>with ratchet, fine jaws</i>	gerade <i>straight</i>	gebogen <i>curved</i>	gerade, diamantiert <i>straight, coated</i>	gebogen, <i>curved, coated</i>
avec crémaillère, mors fine <i>con cremallera, boca fina</i>	droit <i>recta</i>	courbe <i>curva</i>	droit, diamanté <i>recta, diamantada</i>	courbe, diamanté <i>curva, diamantada</i>
con cremagliera, morso fino	retto	curvo	retto, diamantato	curvo, diamantato

Micro Needle Holder

EG-1108-18-A

EG-1108-18-D

Jacobson	1:1	1:1	1:1	1:1
	x = 1mm	x = 1mm	x = 1mm	x = 1 mm
180 mm – 7 "		EG-1108-18-B	EG-1108-18-C	
ohne Sperre <i>without ratchet</i>	gerade <i>straight</i>	gebogen <i>curved</i>	gerade, diamantiert <i>straight, diamond coated</i>	gebogen, diamantiert <i>curved, diamond coated</i>
sans crémaillère <i>sin cremallera</i>	droit <i>recta</i>	courbe <i>curva</i>	droit, diamanté <i>recta, diamantada</i>	courbe, diamanté <i>curva, diamantada</i>
senza cremagliera	retto	curvo	retto, diamantato	curvo, diamantato

	x = 1mm	x = 1mm	x = 1mm	x = 1 mm
180 mm – 7 "	EG-1108-18-A1	EG-1108-18-B1	EG-1108-18-C1	EG-1108-18-D1
mit Sperre <i>with ratchet</i>	gerade <i>straight</i>	gebogen <i>curved</i>	gerade, diamantiert <i>straight, diamond coated</i>	gebogen, diamantiert <i>curved, diamond coated</i>
avec crémaillère <i>con cremallera</i>	droit <i>recta</i>	courbe <i>curva</i>	droit, diamanté <i>recta, diamantada</i>	courbe, diamanté <i>curva, diamantada</i>
con cremagliera	retto	curvo	retto, diamantato	curvo, diamantato

	1:1	1:1	1:1	1:1
	x = 1mm	x = 1mm	x = 1mm	x = 1 mm
180 mm – 7 "	EG-1108-18-A-TC	EG-1108-18-B-TC	EG-1108-18-C-TC	EG-1108-18-D-TC
Sperre <i>ratchet</i>	gerade, glatt <i>straight, smooth</i>	gebogen, glatt <i>curved, smooth</i>	gerade, gerieft <i>straight, serrated</i>	gebogen, gerieft <i>curved, serrated</i>
sans crémaillère <i>sin cremallera</i>	droit, lisse <i>recta, liso</i>	courbe, lisse <i>curva, lisa</i>	droit, strié <i>recta, estriada</i>	courbe, strié <i>curva, estriada</i>
senza cremagliera	retto, liscio	curvo, liscio	retto, zigrinato	curvo, zigrinato



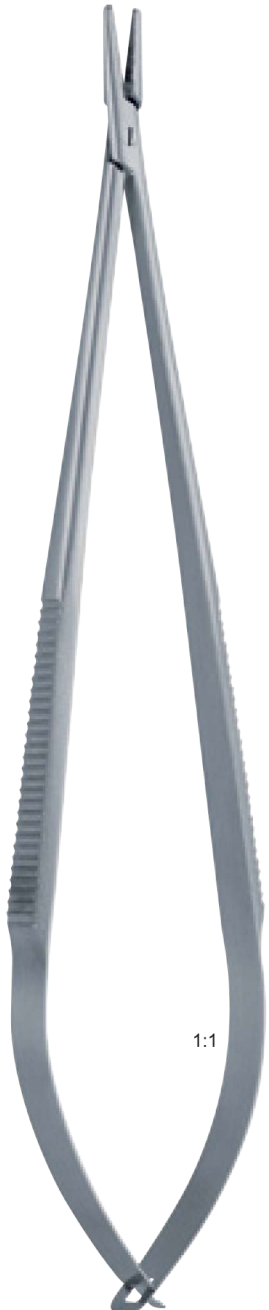

180 mm – 7 "	EG-1108-18-A1-TC	EG-1108-18-B1-TC	EG-1108-18-C1-TC	EG-1108-18-D1-TC
1 mm				
mit Sperre <i>ratchet</i>	glatt <i>straight, smooth</i>	gebogen, glatt <i>curved, smooth</i>	gerade, <i>straight,</i>	gebogen, gerieft <i>curved, serrated</i>
avec crémaillère <i>con cremallera</i>	droit, lisse <i>recta, liso</i>	courbe, lisse <i>curva, lisa</i>	droit, strié <i>recta, estriada</i>	courbe, strié <i>curva, estriada</i>
	retto, liscio	curvo, liscio	retto, zigrinato	curvo, zigrinato



1:1

Plastic Surgery

Micro Needle Holder with Rounded Handle

Barraquer	 1:1	 1:1	 1:1	 1:1	
140 mm – 5 ¹ / ₂ "	8 mm Ø	EG-1109-14-A	EG-1109-14-B	EG-1109-14-C	EG-1109-14-D
ohne Sperre, sehr feines Maul <i>without ratchet, extra delicate jaws</i>	gerade <i>straight</i>	gerade <i>curved</i>	gerade, diamantiert <i>straight, diamond coated</i>	gebogen, <i>curved, diamond coated</i>	
sans crémaillère, mors très fine <i>sin cremallera, boca muy fina</i>	droit <i>recta</i>	gerade <i>curva</i>	droit, diamanté <i>recta, diamantada</i>	courbe, diamanté <i>curva, diamantada</i>	
senza cremagliera, morso molto finoretto	retto	gerade <i>curvo</i>	retto, diamantato	curvo, diamantato	



1:1

140 mm – 5 ¹ / ₂ "	8 mm Ø	EG-1109-14-A	EG-1109-14-B	EG-1109-14-C1	EG-1109-14-D1
mit Sperre, sehr feines Maul <i>with ratchet, extra delicate jaws</i>	gerade <i>straight</i>	gerade <i>curved</i>	gerade, diamantiert <i>straight, diamond coated</i>	gebogen, <i>curved, diamond coated</i>	
avec crémaillère, mors très fine <i>con cremallera, boca muy fina</i>	droit <i>recta</i>	gerade <i>curva</i>	droit, diamanté <i>recta, diamantada</i>	courbe, diamanté <i>curva, diamantada</i>	
con cremagliera, morso molto fino	retto	gerade <i>curvo</i>	retto, diamantato	curvo, diamantato	

Plastic Surgery

Micro Needle Holder with Rounded



110 mm – 4 1/4 "	8 mm Ø	EG-1110-11-A	EG-1110-11-B
125 mm – 5 "	7mm Ø	EG-1110-12-A	EG-1110-12-B
130mm – 5 "	8mm Ø	EG-1110-13-A	EG-1110-13-B
130mm – 5 "	10mm Ø	EG-1110-13-A1	EG-1110-13-B1
150mm – 6 "	8mm Ø	EG-1110-15-A	EG-1110-15-B
180 mm – 7 "	8mm Ø	EG-1110-18-A	EG-1110-18-B
180mm – 7 "	10mm Ø	EG-1110-18-A1	EG-1110-18-B1

ohne Sperre
without ratchet
sans crémaillère
sin cremallera
senza cremagliera

gerade
straight
droit
recta
retto

gebogen
curved
courbe
curva
curvo

110 mm – 4 1/4 "	8 mm Ø	EG-1110-11-C	EG-1110-11-D
125mm – 5 "	7mm Ø	EG-1110-12-C	EG-1110-12-D
130mm – 5 "	8mm Ø	EG-1110-13-C	EG-1110-13-D
130mm – 5 "	10mm Ø	EG-1110-13-C1	EG-1110-13-D1
150mm – 6 "	8mm Ø	EG-1110-15-C	EG-1110-15-D
180mm – 7 "	8mm Ø	EG-1110-18-C	EG-1110-18-D
180mm – 7 "	10mm Ø	EG-1110-18-C1	EG-1110-18-D1

mit Sperre
with ratchet
avec crémaillère
con cremallera
con cremagliera





gerade
straight
droit
recta
retto

gebogen
curved
courbe
curva
curvo





Plastic Surgery

Micro Needle Holder with Rounded



Yasargil	 1:1	 1:1	 1:1	 1:1
	x = 1mm	x = 1mm	x = 1mm	x = 1 mm
210 mm – 8 ₄ "	EG-1111-21-A	EG-1111-21-B	EG-1111-21-C	EG-1111-21-D
ohne Sperre without ratchet	<i>straight</i>	gebogen <i>curved</i>	diamantiert <i>straight, diamond coated</i>	gebogen, <i>curved, diamond coated</i>
sans crémaillère sin cremallera	droit <i>recta</i>	courbe <i>curva</i>	droit, diamanté <i>recta, diamantado</i>	courbe, diamanté <i>curva, diamantado</i>
senza cremagliera	retto	curvo	retto, diamantato	curvo, diamantato

	x = 1mm	x = 1mm	x = 1mm	x = 1 mm
210 mm – 8 ₄ "	EG-1111-21-A1	EG-1111-21-B1	EG-1111-21-C1	EG-1111-21-D1
mit Sperre with ratchet	<i>straight</i>	gebogen <i>curved</i>	diamantiert <i>straight, diamond coated</i>	gebogen, <i>curved, diamond coated</i>
avec crémaillère con cremallera	droit <i>recta</i>	courbe <i>curva</i>	droit, diamanté <i>recta, diamantada</i>	courbe, diamanté <i>curva, diamantada</i>
con cremagliera	retto	curvo	retto, diamantato	curvo, diamantato

	 1:1	 1:1	 1:1	 1:1
	x = 1mm	x = 1mm	x = 1mm	x = 1 mm
210 mm – 8 ₄ "	EG-1111-21-A-TC	EG-1111-21-B-TC	EG-1111-21-C-TC	EG-1111-21-D-TC
without ratchet	<i>straight, smooth</i>	<i>curved, smooth</i>	<i>straight, serrated</i>	<i>curved, serrated</i>

	x = 1mm	x = 1mm	x = 1mm	x = 1 mm
210 mm – 8 ₄ "	EG-1111-21-A1-TC	EG-1111-21-B1-TC	EG-1111-21-C1-TC	EG-1111-21-D1-TC
without ratchet	<i>straight, smooth</i>	<i>curved, smooth</i>	<i>straight, serrated</i>	<i>curved, serrated</i>

Plastic Surgery

Micro Needle Holder with Rounded



1:1



1:1



1:1



1:1



1:1

	0.4 x 0.6mm	0.4 x 0.6mm	0.6 x 0.6mm	0.6 x 0.6 mm
200 mm – 8 "	EG-1113-20-A	EG-1113-20-B	EG-1113-20-C	EG-1113-20-D

Titan, mit Sperre

Titanium, with ratchet

Titane, avec crémaillère

Titanio, con cremallera

Titanio, con cremagliera

Plastic Surgery

Micro Needle Holder with Rounded

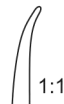
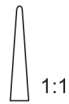

	0.3 mm x 0.4 mm	0.3 mm x 0.4 mm
180 mm – 7"	EG-1114-14-A	EG-1114-14-B

Titan, mit Sperre
Titanium, with ratchet
 Titane, avec crémaillère
Titanio, con cremallera
 Titanio, con cremagliera

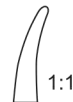

	0.8 mm x 0.8 mm	0.8 mm x 0.8 mm
185 mm – 7 ¹ / ₄ "	EG-1114-18-A	EG-1114-18-B

Titan, mit Sperre
Titanium, with ratchet
 Titane, avec crémaillère
Titanio, con cremallera
 Titanio, con cremagliera

Mallets

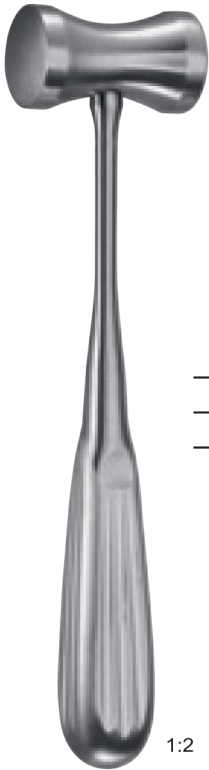

1:2

Hajek	
	27 mm Ø – 140 g
215 mm – 8 1/2"	EG-1115-21

Stahl massiv
Steel solid
 Acier solide
Acero solido
 Acciaio massiccio



1:2

Collin	
	30 mm Ø – 220 g
200 mm – 8"	EG-1115-20

Stahl massiv
Steel solid
 Acier solide
Acero solido
 Acciaio massiccio



1:2

Mead		
	26 mm Ø – 320 g	26 mm Ø – 320 g
170 mm – 6 3/4"	EG-1115-17-A	EG-1115-17-B

Stahl massiv, mit Ferrozellbacken Ersatzbacken, 1 Paar
Steel solid, with Ferrozell faces Spare faces, 1 pair
 Acier solide, avec plaques en Ferrozell Plaques de rechange, 1 paire
Acero solido, con placas en Ferrozell Placas de cambio, 1 par
 Acciaio massiccio, con punte di Ferrozell Placche di ricambio, 1 paia



Mallet
 260 mm – 8"
 Ferrozell, without lead



1:2

Partsch

	22 mm Ø – 200 g
180 mm – 7"	EG-1116-18



1:2

	20 mm Ø – 140 g
165 mm – 6½"	EG-1116-20



1:2

	25 mm Ø – 205 g
190 mm – 7½"	EG-1116-19-A

Stahl massiv, mit Kunststoffbacken
Steel solid, with plastic faces

Acier solide, avec plaques en plastic
Acero solido, con placas en plastica
Accaio massiccio, con placche di plastica



Lucae

	19 mm Ø – 230 g	25 mm Ø – 260 g
190 mm – 7½"	EG-1116-19-B	EG-1116-19-C

Stahl massiv
Steel solid

Acier solide
Acero solido
Accaio massiccio

Plastic Surgery

Chisel, Osteotomes for Rhinoplasty



1:1

1:2

Kilian

	5 mm
160 mm – 6¼"	EG-1117-16-A



1:1

1:2

Kilian-Claus

	5 mm
160 mm – 6¼"	EG-1117-16-B



1:2

1:1

1:1

Cottle

	7 mm	12 mm
150 mm – 6"	EG-1117-15-A	EG-1117-15-B

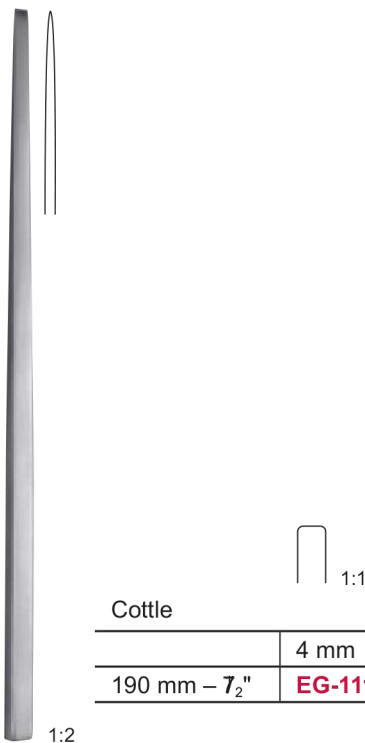

1:1

1:2

Cottle

	4 mm
190 mm – 7½"	EG-1117-19

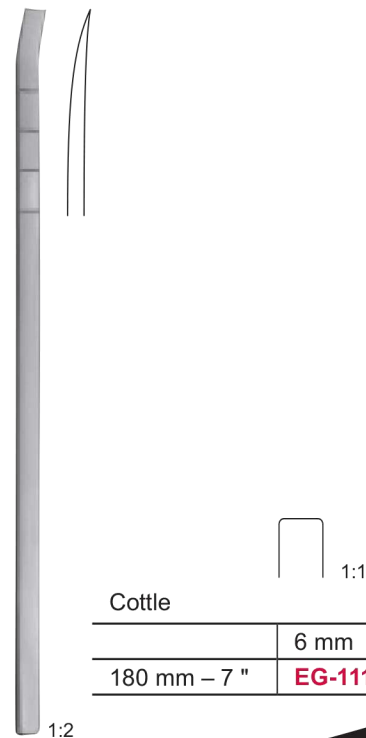

1:1

1:2

Cottle

	6 mm
180 mm – 7"	EG-1117-18



Cottle	4 mm	7 mm	9 mm	12 mm
180 mm – 7"	EG-1118-18-A	EG-1118-18-B	EG-1118-18-C	EG-1118-18-D



Cottle	4 mm	7 mm	9 mm	12 mm
180 mm – 7"	EG-1118-18-A1	EG-1118-18-B1	EG-1118-18-C1	EG-1118-18-D1



Fomon

	4 mm	5 mm	6 mm	7 mm	8 mm
170 mm – 6 ³ / ₄ "	EG-1119-17-A	EG-1119-17-B	EG-1119-17-C	EG-1119-17-D	EG-1119-17-E

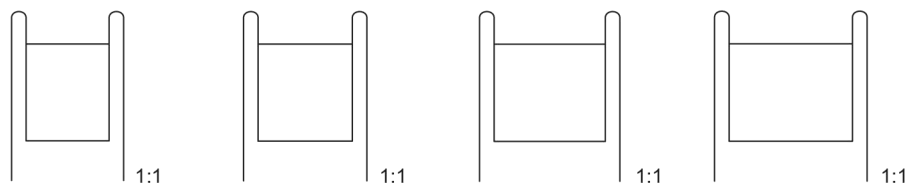

Cinelli

	10 mm	12 mm	14 mm	16 mm
180 mm – 7"	EG-1119-18-A	EG-1119-18-B	EG-1119-18-C	EG-1119-18-D



Cakir

200 mm – 8"

EG-1120-17

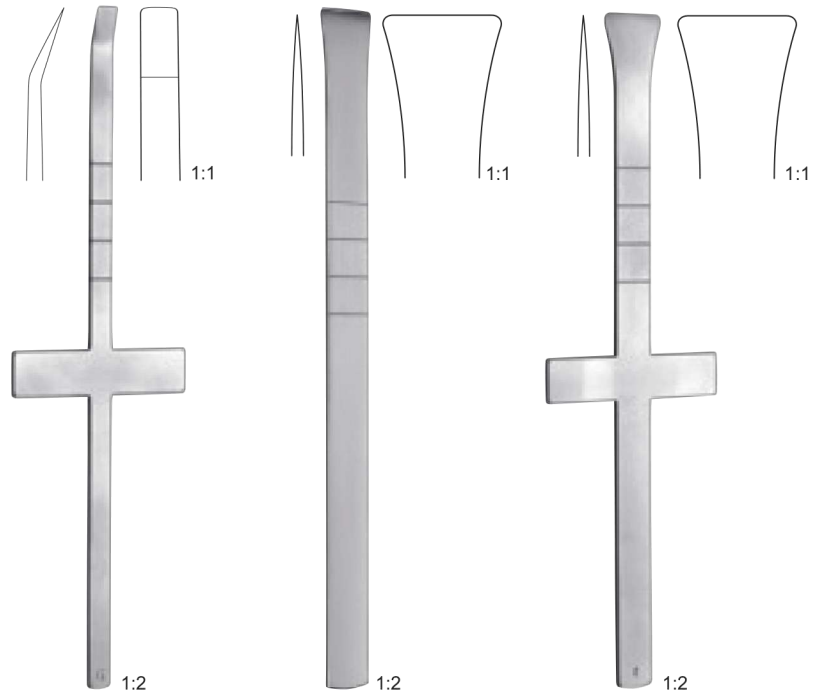

Cottle

	6 mm	16 mm	16 mm
180 mm – 7"	EG-1120-18-A	EG-1120-18-B	EG-1120-18-C



Cottle

	4 mm	7 mm	9 mm	12 mm
200 mm – 8"	EG-1120-20-A	EG-1120-20-B	EG-1120-20-C	EG-1120-20-D



Cottle-Gubisch

Hohlschliff
Hollow cut
Vaciado hueco
Rectifi cation en creux
Levigatura vuota

graduiert
graduated
graduada
graduée
graduata



1:2

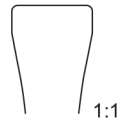

1:1

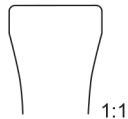

1:1

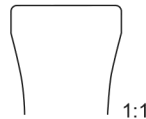

1:1

Rubin

	10 mm	12 mm	14 mm
180 mm – 7"	EG-1121-18-A	EG-1121-18-B	EG-1121-18-C



1:2

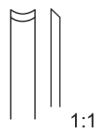

1:1

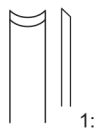

1:1

Walter

	3 mm	4,5 mm
190 mm – 7 ₂ "	EG-1121-19-A	EG-1121-19-B



1:1

Gubbisch

18,5 cm - 7 1/4"

a = 2mm	EG-1121-20-A
a = 3mm	EG-1121-20-B

Aluminiumgriff
Aluminium handle
Mango de aluminio
Manche en aluminium
Manico in alluminio



1:2

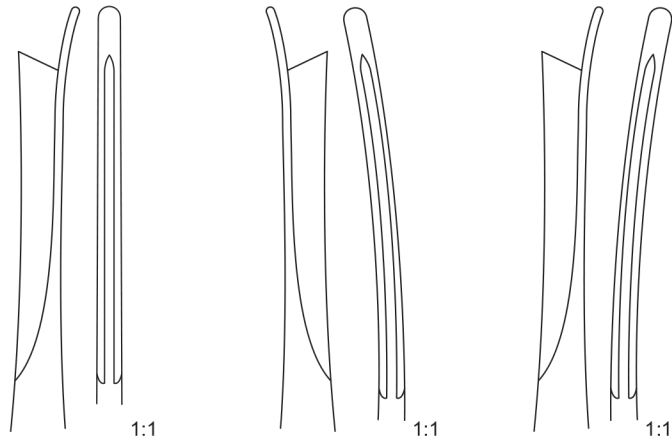

Silver

180 mm – 7"	EG-1122-18-A	EG-1122-18-B	EG-1122-18-C
gerade <i>straight</i>	rechts <i>right</i>	links <i>left</i>	
droit <i>recta</i>	droite <i>derecha</i>	gauche <i>izquierda</i>	
rette	destra	sinistra	



1:2

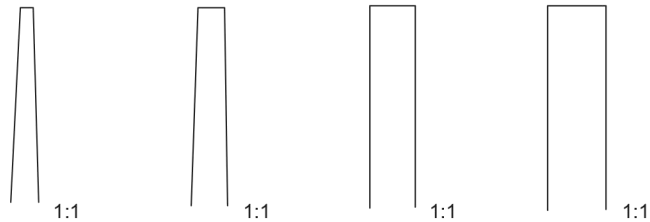

Sheehan

	2 mm	4 mm	6 mm	8 mm
160 mm – 6 $\frac{1}{4}$ "	EG-1122-16-A	EG-1122-16-B	EG-1122-16-C	EG-1122-16-D

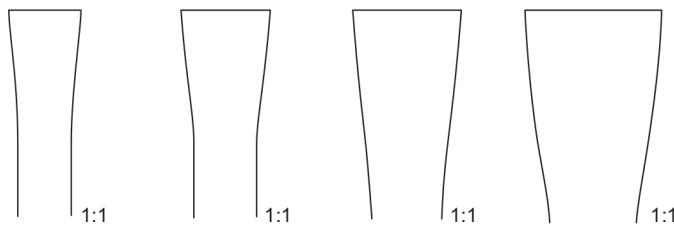

	10 mm	12 mm	15 mm	18 mm
160 mm – 6 $\frac{1}{4}$ "	EG-1122-16-A1	EG-1122-16-B1	EG-1122-16-C1	EG-1122-16-D1

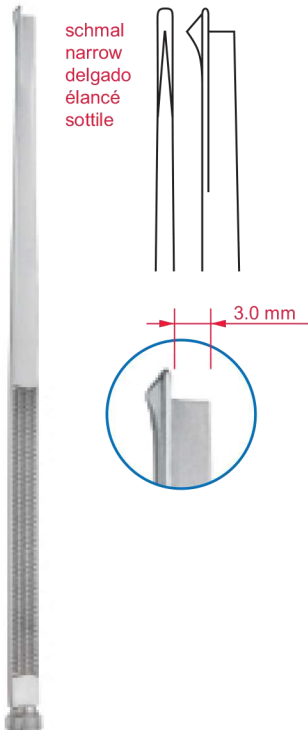

schmal
narrow
delgado
élancé
sottile

3.0 mm

Fanous Gubisch
200 mm – 8 "
EG-1123-20-D

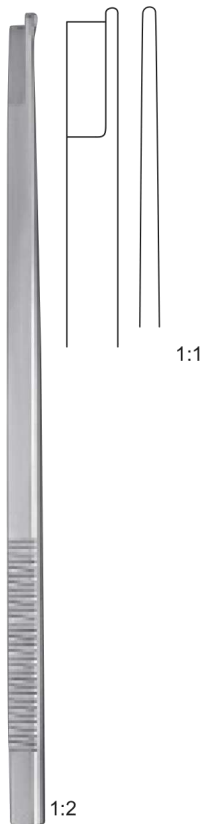

1:1

1:2

Neivert
200 mm – 8 "
EG-1123-20-A

gerade
straight
droit
recta
rette

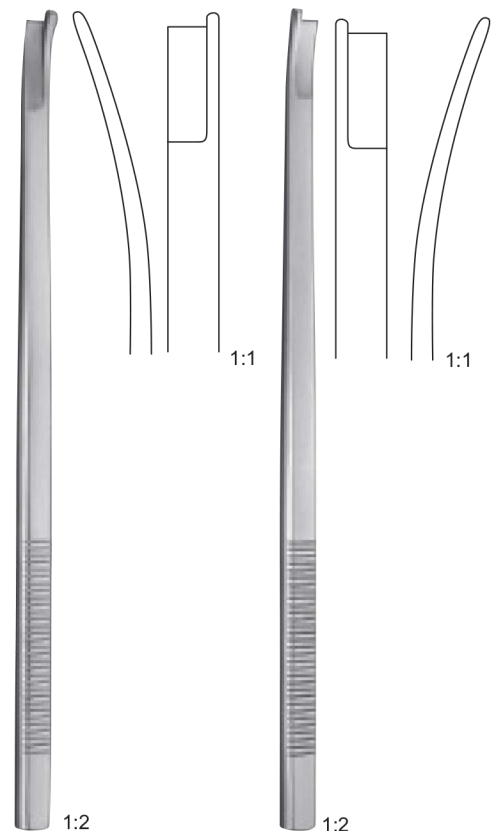

1:1

1:1

1:2

1:2

Neivert-Anderson
200 mm–8 "

rechts
right
droite
derecha
destra

links
left
gauche
izquierda
sinistra

EG-1123-20-B

EG-1123-20-C

Plastic Surgery

Septum Elevators

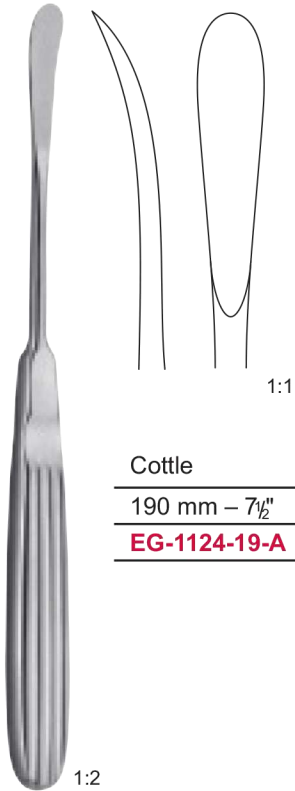

Cottle
 190 mm – 7½"
EG-1124-19-A

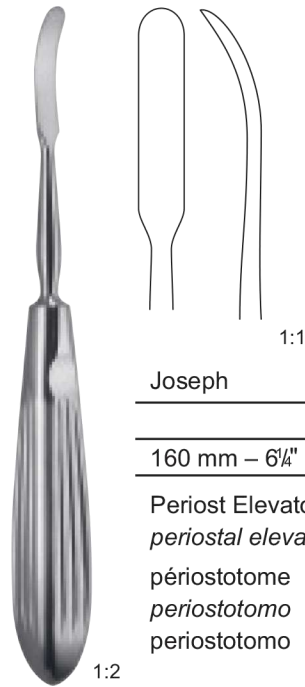

Joseph
 4 mm
 160 mm – 6¼" **EG-1124-16-A**

Periost Elevatorium
periostal elevator
périostotome
periostotomo
periostotomo



Halle
 160 mm – 6¼"
EG-1124-16-B



Ballenger-Hajek
 190 mm – 7½" **EG-1124-19-B**
 220 mm – 8¾" **EG-1124-20**

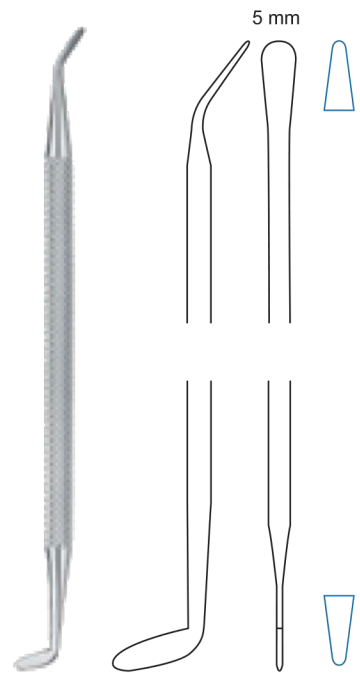

Nagata
 160 mm – 6¼"
EG-1124-16

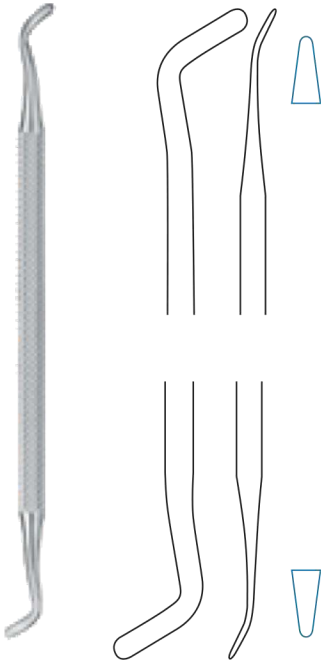

Nagata
170 mm
EG-1125-00

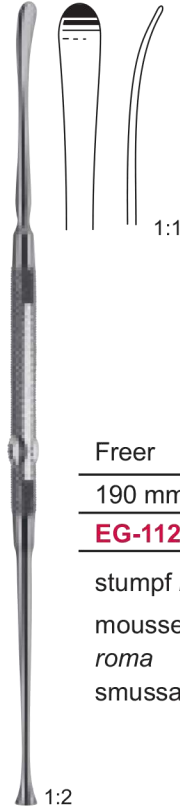

Freer
190 mm – 7 1/2"
EG-1125-19
stumpf *blunt*
mousse
roma
smussa

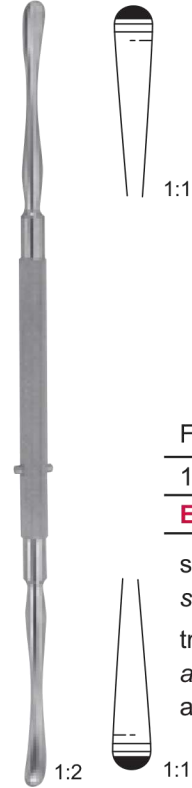

Fr eer
180 mm – 7 "
EG-1125-18
scharf/stumpf
sharp/blunt
tranchant/mousse
aguda/roma
acuta/smussa

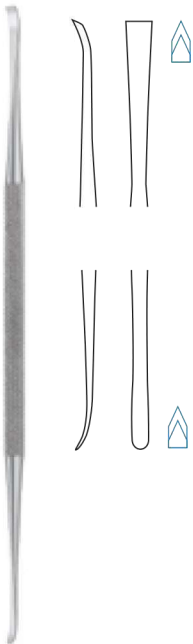

Daniel-Cakir
200 mm – 7 "
EG-1125-20



Cuttin-Burr
70 mm
EG-1125-07

Ø 1,4 mm



Lindemann
45 mm
EG-1125-14



Cottle

2.5 mm
160 mm – 6 1/4" **EG-1125-16**

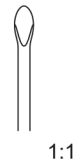

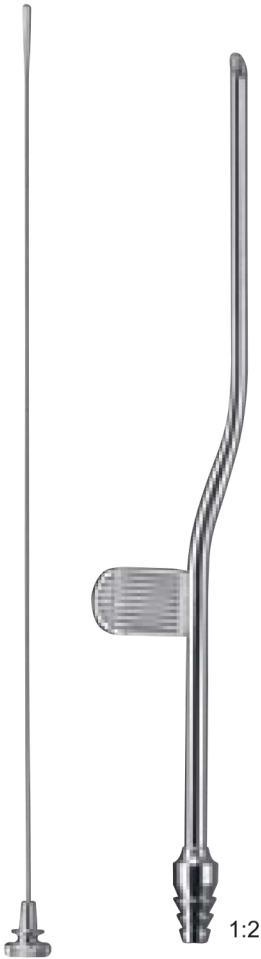

200 mm – 8 " **EG-1126-20**

Saug-Raspatorium – biegsam, scharf
suction raspatory – malleable, sharp
 rugine aspirante – fl exible, tranchant
legra aspiradora – maleable y agudo
 elevatore-aspiratore – fl essibile, tagliente

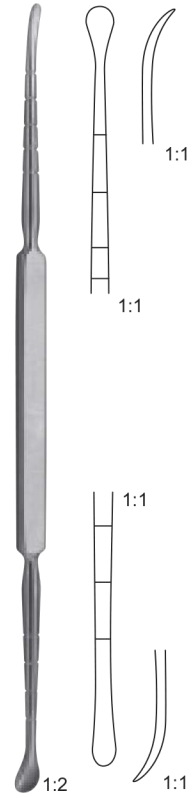

Cottle
 210 mm – 8 1/4 " **EG-1126-21**

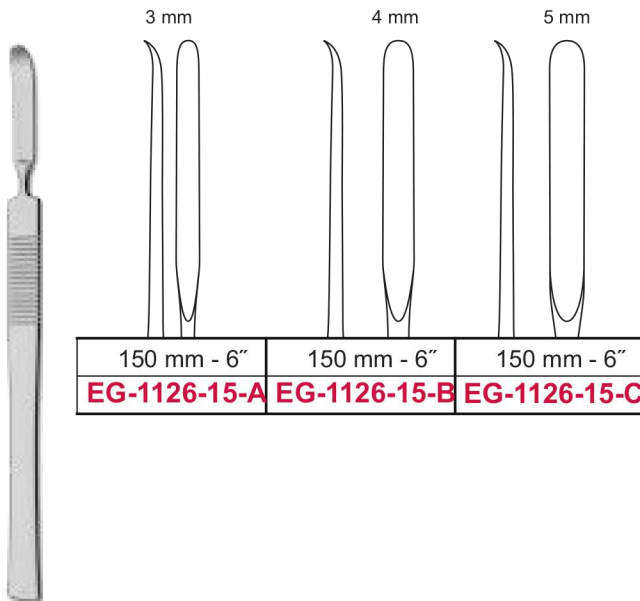

150 mm - 6"	150 mm - 6"	150 mm - 6"
EG-1126-15-A	EG-1126-15-B	EG-1126-15-C

McKenty



Suction Tube
 210 mm
EG-1126-00

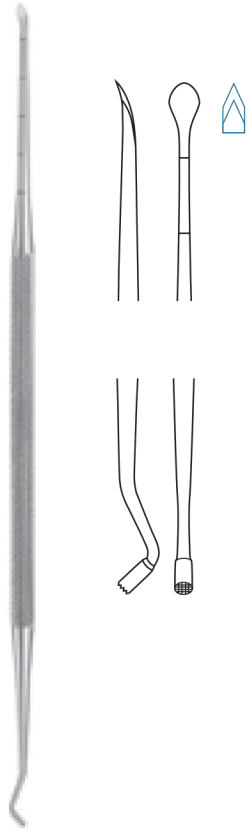

Cottle-Daniel

210 mm – 8 1/4"

EG-1127-21



Freer

205 mm – 8"

EG-1127-25

scharf/stumpf
sharp/blunt
tranchant/mousse
aguda/roma
acuta/smussa



Masing

200 mm – 8"

EG-1127-20



Cottle

220 mm – 8 3/4"

EG-1127-22

Plastic Surgery

Periosteal Elevators and Awls



1:2



1:2



1:1



1:1



1:1



1:1

Obwegeser

	6 mm	7 mm	9 mm	11 mm
175 mm – 7"	EG-1128-28-A	EG-1128-28-B	EG-1128-28-C	EG-1128-28-D



1:2

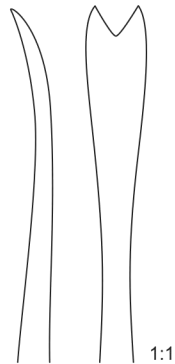

1:1

Obwegeser

175 mm – 7"

EG-1128-17



1:2



1:1

Obwegeser

180 mm – 7"

EG-1128-18



1:2



1:1

Obwegeser

140 mm – 5½"

EG-1128-14



1:2



1:1

Obwegeser

230 mm – 8"

EG-1128-23

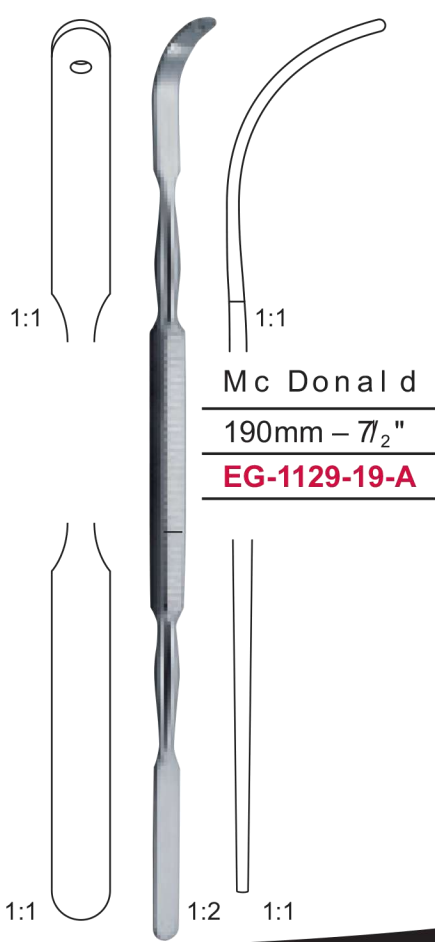
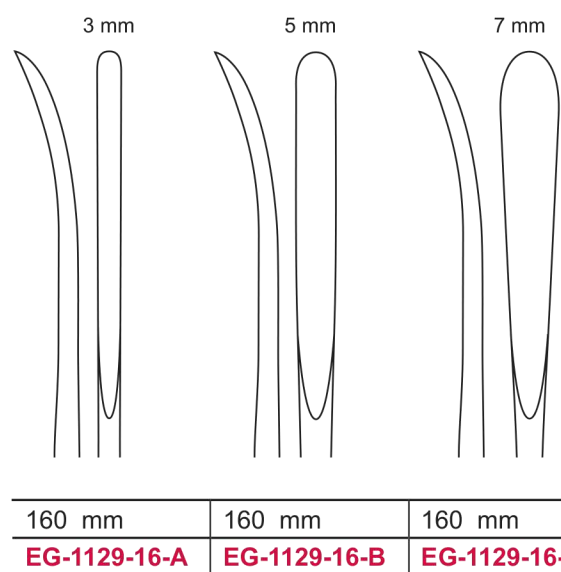
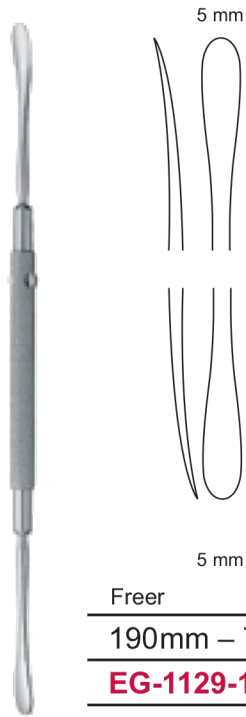

Plastic Surgery

Periosteal Elevators and Awls

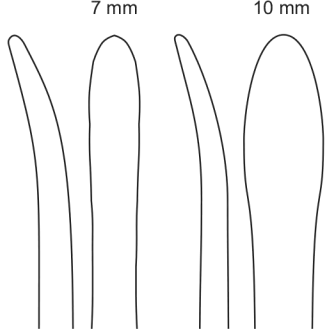

200 mm	200 mm
EG-1130-20-A	EG-1130-20-B

Langenbeck



Obwegeser

	7 mm	10 mm
215 mm – 8 ₂ "	EG-1130-21-A	EG-1130-21-B



1:2

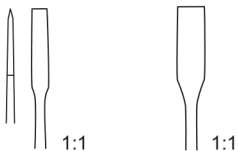

Obwegeser	2,5 mm	4 mm
150 mm – 6 "	EG-1130-15-A	EG-1130-15-B



Freer-

160 mm – 6.25
EG-1130-16



Tebbets

150 mm
EG-1130-15



Ramirez Type Endoscopic Plastic Instruments

235 mm ^{Half Curved} EG-1130A-01	235 mm ^{Straight} EG-1130A-02	235 mm ^{Half Curved} EG-1130A-06	235 mm ^{Half Curved Left} EG-1130A-07	235 mm ^{Half Curved} EG-1130A-09
	235 mm ^{Quarter Curved} EG-1130A-03		235 mm ^{Half Curved Right} EG-1130A-08	
	235 mm ^{Half Curved} EG-1130A-04			
	235 mm ^{Full Curved} EG-1130A-05			



Ramirez Type Endoscopic Plastic Instruments

240 mm	240 mm	265 mm	253 mm	280 mm	255 mm	260 mm	250 mm	225 mm	230 mm
EG-1130-01	EG-1130-02	EG-1130-03	EG-1130-04	EG-1130-05	EG-1130-06	EG-1130-07	EG-1130-08	EG-1130-09	EG-1130-10

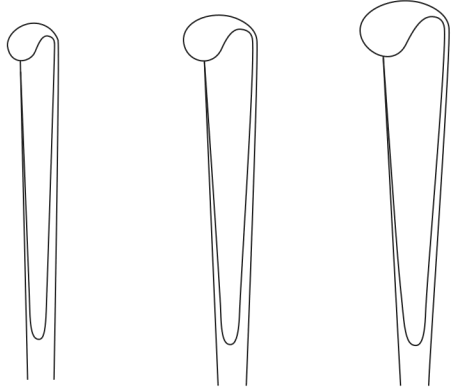

Obwegeser

	5 mm	8 mm	9 mm
200 mm – 8"	EG-1131-20-A	EG-1131-20-B	EG-1131-20-C

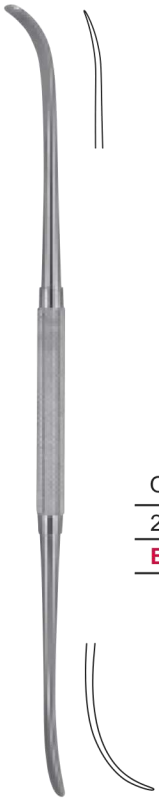

Obwegeser
210 mm – 8 $\frac{1}{4}$ "
EG-1131-21-A



Obwegeser
210 mm – 8 $\frac{1}{4}$ "
EG-1131-21-B



Obwegeser
235 mm – 9 $\frac{1}{4}$ "x
x = 11 mm
EG-1131-23



Obwegeser
185 mm – 7 $\frac{1}{4}$ "
EG-1131-18-A



Obwegeser
185 mm – 7 $\frac{1}{4}$ "
EG-1131-18-B

Nasal Specula



1:2

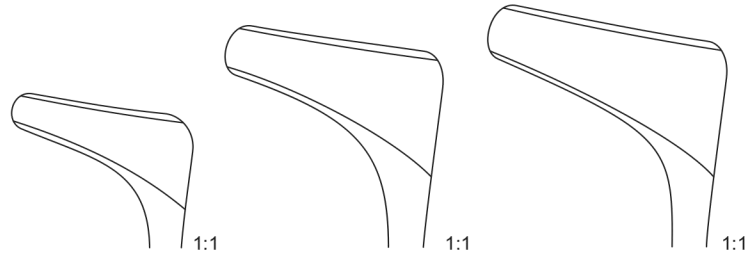

Hartmann-Halle

150 mm – 6 "

EG-1132-15-A

EG-1132-15-B

EG-1132-15-C



1:2

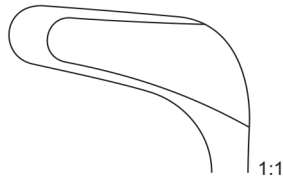

1:1

Schwarz

140 mm – 5₂"

EG-1132-14



1:2

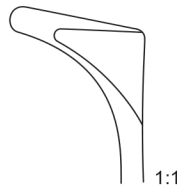

1:1

Tieck-Halle

135 mm – 5₄"

EG-1132-13



50 mm

Cottle

130 mm

EG-1132-16



1:2

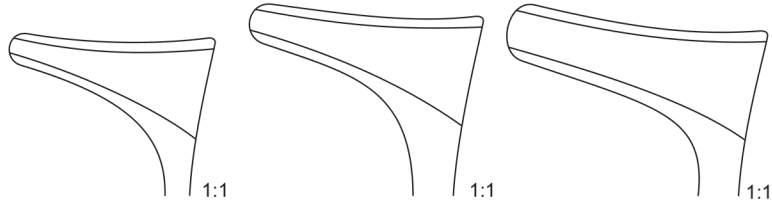

Modell Wien

145 mm – 5.4"	EG-1133-14-A	EG-1133-14-B	EG-1133-14-C
---------------	---------------------	---------------------	---------------------



1:2

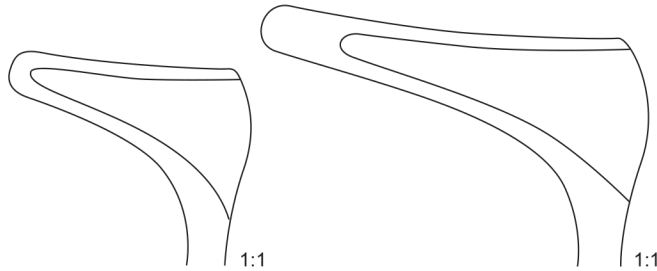

Cottle

	x = 35 mm	x = 50 mm
150 mm – 6"	EG-1133-15-A	EG-1133-15-B

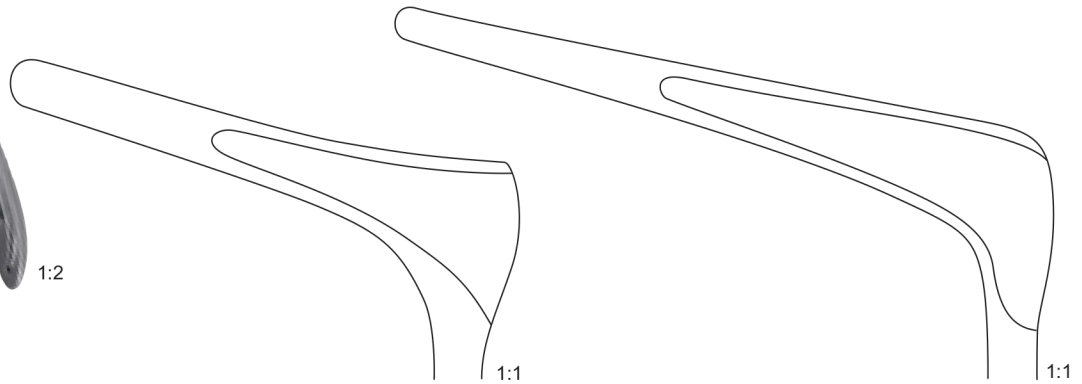

Cottle

	x = 75 mm	x = 90 mm
150 mm – 6"	EG-1133-15-A1	EG-1133-15-B1

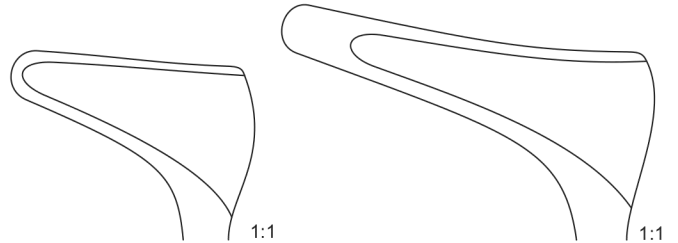

Kilian	x = 35 mm	x = 50 mm
130 mm – 5"	EG-1134-13-A	EG-1134-13-B

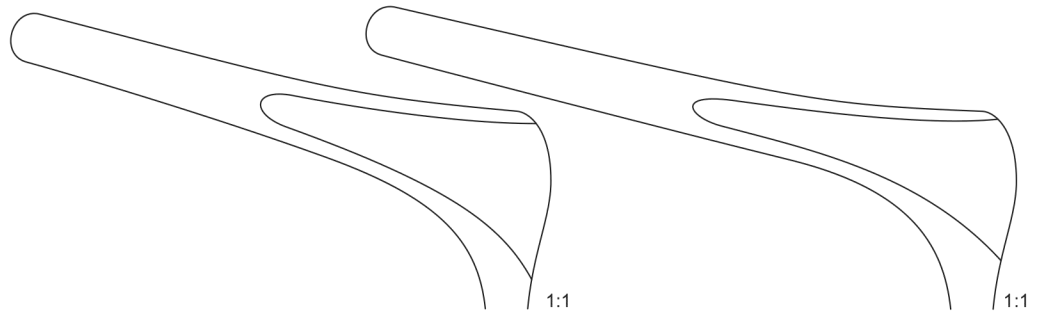

	x = 75 mm	x = 90 mm
130 mm – 5"	EG-1134-13-A1	EG-1134-13-B1

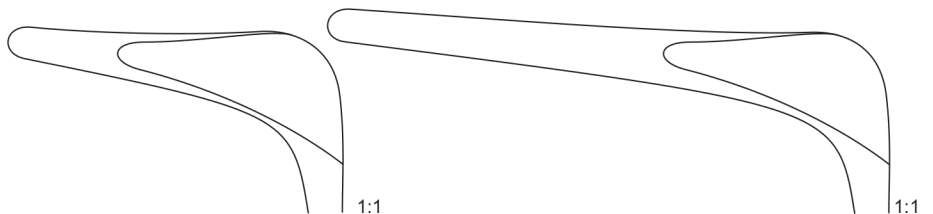

Cottle	x = 45 mm	x = 75 mm
140 mm – 5½"	EG-1134-14-A	EG-1134-14-B

schwarz verchromt
 black, chrome plated
 chromé en noir
 cromado en negro
 cromato nero

Nasal Saws



Castroviejo
210 mm – 8 $\frac{1}{4}$ "
EG-1135-01

Joseph
170 mm – 6 $\frac{3}{4}$ " | **EG-1135-17-A** | **EG-1135-17-B**



Aufricht
210 mm – 8 $\frac{1}{4}$ " | **EG-1135-21**
auf Zug und auf Stoss schneidend
drawing and pushing cut
tranchant à traction et en poussant
cortante a tracción y empuje
tagliante a trazione e a urto



Buchawald
230 mm – 8"
EG-1135-00



Joseph
190 mm – 7 $\frac{1}{2}$ " | **EG-1135-19-A** | **EG-1135-19-B**

Plastic Surgery

Nasal Rasps

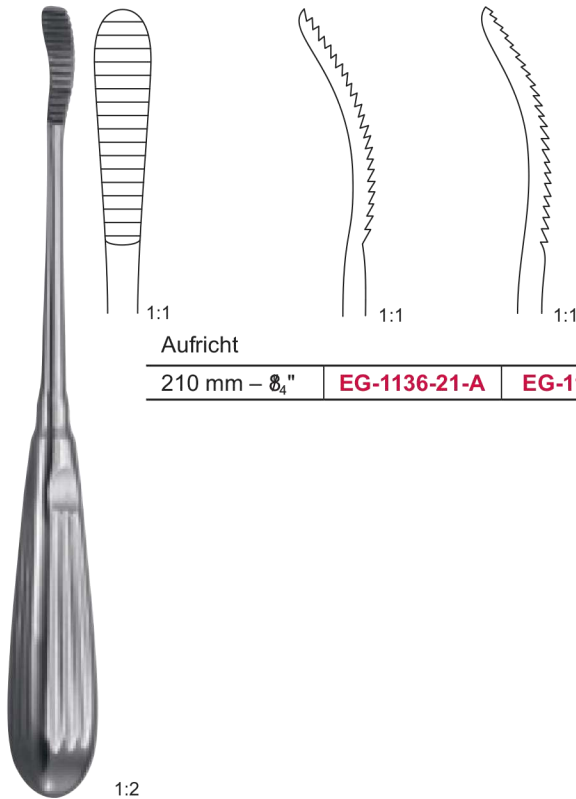

Aufricht

210 mm – 8 $\frac{1}{4}$ " **EG-1136-21-A** **EG-1136-21-B**

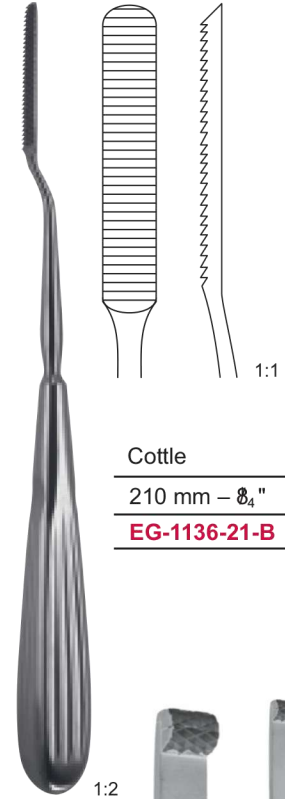

Cottle

210 mm – 8 $\frac{1}{4}$ "

EG-1136-21-B

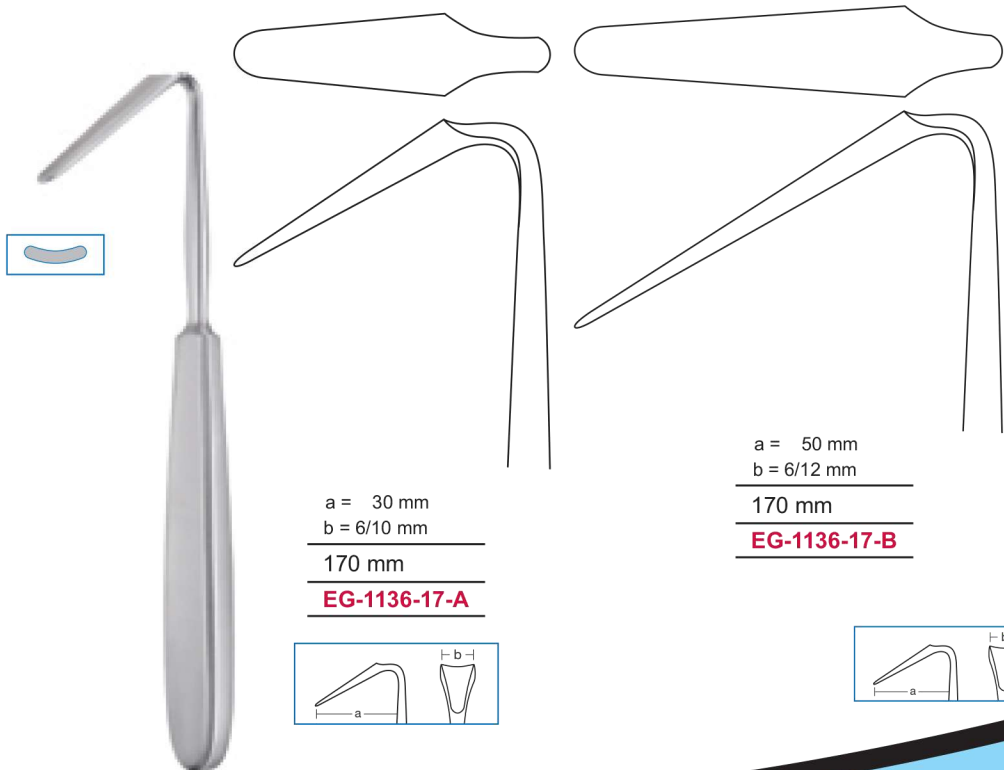

a = 30 mm
b = 6/10 mm

170 mm

EG-1136-17-A

a = 50 mm
b = 6/12 mm

170 mm

EG-1136-17-B

Webster Glabella

215 mm

EG-1136-21

Gubisch-Aufricht

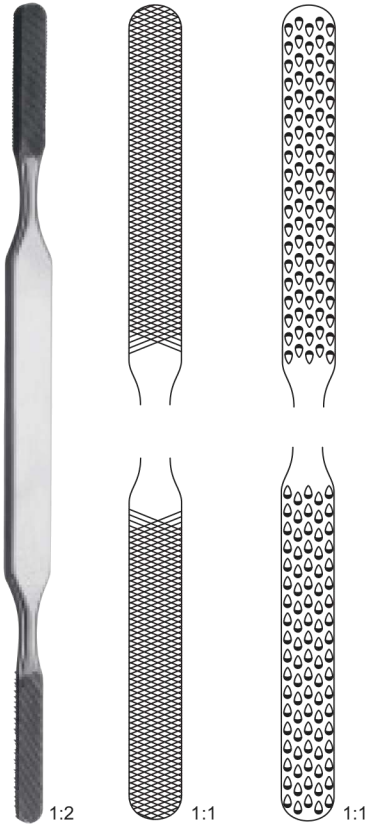

Fomon

210 mm – 8₄"

EG-1137-21

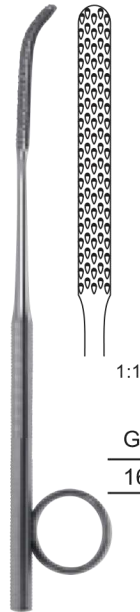

1:1

Gallaher

160 mm – 6₄"

EG-1137-16-A

EG-1137-16-B

EG-1137-16-C

Schlüssel
Wrench
Llave
Clé
Chiave



EG-1137-00

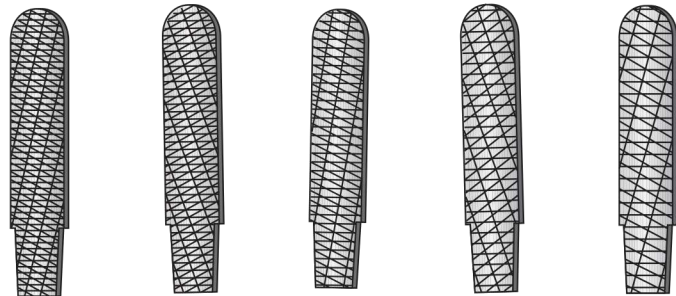

1:1

# 1	# 2	# 3	# 4	# 5
EG-1137-01	EG-1137-02	EG-1137-03	EG-1137-04	EG-1137-05

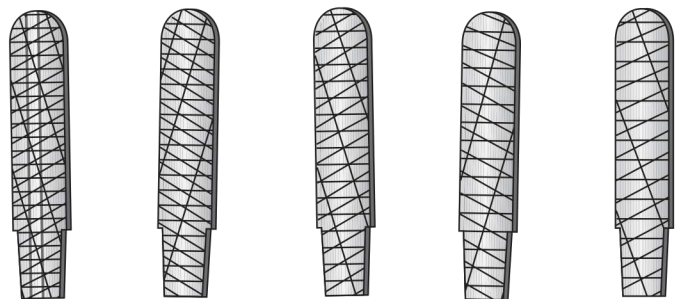

# 6	# 7	# 8	# 9	# 10
EG-1137-06	EG-1137-07	EG-1137-08	EG-1137-09	EG-1137-10

1:1



Handles
Mangos
Manches
Manici
Handgriffe

140 mm

150 mm

EG-1137-15-A

EG-1137-15-B

Plastic Surgery

Rasps with Tungsten Carbide

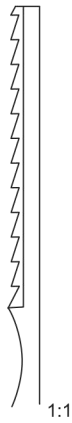

Fig. 1	Fig. 3	Fig. 5	Fig. 7	Fig. 9
12	16	24	36	52

Zähne
Teeth
Dentes
Dientes
Denti

Fomon TC

200 mm – 8"	EG-1138-20-A-TC	EG-1138-20-B-TC	EG-1138-20-C-TC	EG-1138-20-D-TC	EG-1138-20-E-TC
200 mm – 8"	EG-1138-20-A	EG-1138-20-B	EG-1138-20-C	EG-1138-20-D	EG-1138-20-E

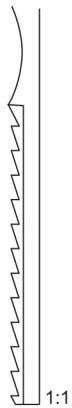
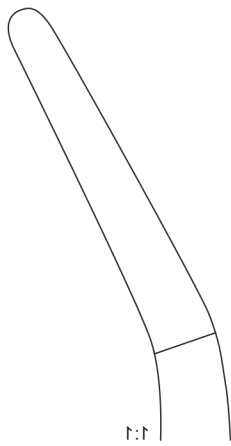

Fig. 2	Fig. 4	Fig. 6	Fig. 8	Fig. 10
14	20	30	44	62

Zähne
Teeth
Dentes
Dientes
Denti

Septum Forceps



Asch

230 mm – 9 "

EG-1139-23-A



s:t



1:2

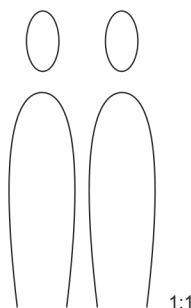

1:1

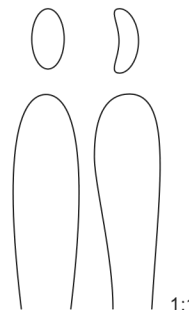

1:1

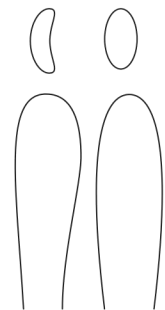

1:1

Cottle-Walsham

230 mm – 9 "

EG-1139-23-B

EG-1139-23-C

EG-1139-23-D

gerade
straight

droit
recta
rette

links
left
gauche
izquierda
a sinistra

rechts
right
droite
derecha
a destra

Resection Saws



185 mm
EG-1140A-18-A



185 mm
EG-1140A-18-B



185 mm
EG-1140A-18-C



185 mm
EG-1140A-18-D



185 mm
EG-1140A-18-E



185 mm
EG-1140A-18-F



185 mm
EG-1140A-18-G



1:2



1:1

Middleton-Jansen

190 mm – 7 1/2" **EG-1140-19-A**



1:2

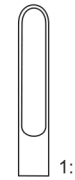

1:1

Middleton-Jansen

190 mm – 7 1/2" **EG-1140-19-B**



1:2

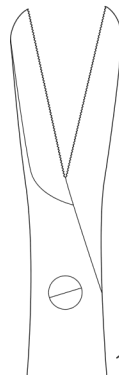

1:1

Caplan

200 mm – 8" **EG-1140-20**

gezahnt
toothed
dentelée
dentado
dentato



1:2



1:1

Rubin

210 mm – 8 1/4" **EG-1140-21**



EG-1140-01

Schutzkappe
Protection Cap
Capuchon protecteur
Caperuza protectora
Calotta protettiva

Tendon Stripper



1:2

1:1

1:1

1:1

	4.0 mm Ø	4.5 mm Ø	5.5 mm Ø
230 mm – 9"	EG-1141-23-A	EG-1141-23-B	EG-1141-23-C

Schaft biegsam
Malleable shaft

Tige malléable
Tija maleable
Asta malleabile



Daniel

310 mm – 12¹/₄"

EG-1141-31



1:2

Bunnell

1:1

1:1

1:1

	Fig. 1	Fig. 2	Fig. 3
150 mm – 6"	EG-1141-15-A	EG-1141-15-B	EG-1141-15-C

1:1

1:1

Fig. 4

EG-1141-15-D

Fig. 5

EG-1141-15-E

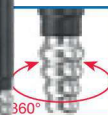
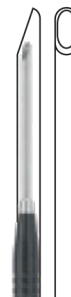

Schlauchansatz, drehbar
Tube connection, rotatable
Empalme de tubo, giratorio
Embout de tuyau, rotatif
Attacco per il tubo, girevole

Haraldsson

185 mm

EG-1141-16



Fischer
 310 mm – 12 $\frac{1}{4}$ "
EG-1142-31



Bunnell
 230 mm – 9"
EG-1142-23





Kleinert-
 Kutz
 200 mm – 8"
 20 mm Ø
EG-1142-20

Sehndurchzugs-sonde
Tendon passer
 Sonde conductrice pour tendons
Sonda conductora de tendones
 Sonda conduttrice per tendini

Tendon Holding Forceps



Brand	 1:1	 1:1	 1:1
	150mm – 6"	190mm – 7 1/2"	240mm – 9 1/2"
	EG-1143-15	EG-1143-19	EG-1143-24

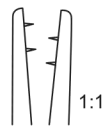

1:1

130mm – 5"
EG-1143-13

1:2

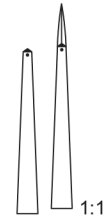

1:1

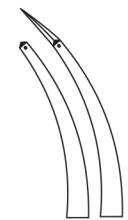

1:1

150 mm – 6" **EG-1143-15-A** | **EG-1143-15-B**

1:2



205 mm – 8 "	EG-1144-20-A	EG-1144-20-B
--------------	---------------------	---------------------

Sehrendurchzugszange
Tendon passer
 Pince conductrice pour tendons
Pinza conductora para tendones
 Pinza conduttrice per tendini



Caroll
 110mm – 4 1/4"
EG-1144-11

Sehnenfaßzange
Tendongraspingforceps
 Pince pour saisir les tendons
Pinza para coger tendones
 Pinza per afferrare tendini



BACKHAUS
 130mm – 5 1/8 " 85 mm – 5 1/8 "
EG-1144-13-A **EG-1144-13-B**

Bone Ronguers



Mini-Friedman
120 mm – 4 1/4"
EG-1145-12



Friedman
140 mm – 5 1/2"
EG-1145-14

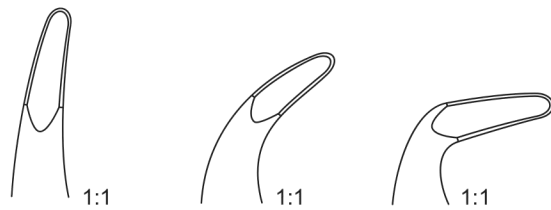

Blumenthal

	Fig. 1	Fig. 2	Fig. 3
155 mm – 6 "	EG-1145-15-A	EG-1145-15-B	EG-1145-15-C



Böhler

150 mm – 6 "



1:1



1:1

EG-1146-15-A

EG-1146-15-B

1:2



Stellbrink

175 mm – 7 "



1:1

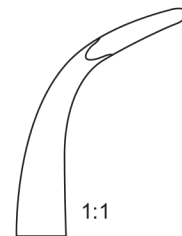

1:1

EG-1146-17-A

EG-1146-17-B

leicht gebogen
slightly curved

légèrement courbe
ligeramente curvada
leγεGente curvata

stark gebogen
strongly curved

très courbe
fuertemente curvada
fortemente curvata

1:2



Zaufal-Jansen

180 mm – 7 "

EG-1147-18-A



Marquardt

200 mm – 8 "

EG-1147-20



Beyer

180 mm – 7 "

EG-1147-18-B



Ruskin

180 mm – 7 "

EG-1147-18-C

EG-1147-18-D

Plastic Surgery

Bone Cutting Forceps



Cottle-Kazanjan

190 mm – 7₂"

EG-1148-19



Böhler

150 mm – 6"

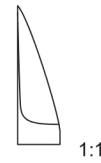

1:1

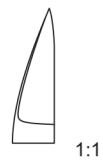

1:1

EG-1148-15-A

EG-1148-15-B



Ruskin-Liston

185 mm – 7₄"

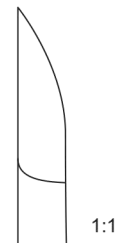

1:1

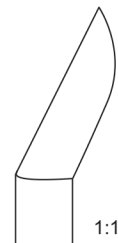

1:1

EG-1148-18-A

EG-1148-18-B

Tränenkanal-Dilatator

Lacrimal dilators

Dilatateurs pour le canal lacrymal

Dilatadores para el canal lacrimal

Dilatatori lacrimali



Bowman

Fig. 000 / 00	Fig. 00' 0	Fig. 0 / 1	Fig. 1 / 2	Fig. 2 / 3
0.4/ 0.6 mm Ø	0.7/ 0.8 mm Ø	0.8/ 0.9 mm Ø	0.9/ 1.1 mm Ø	1.1/ 1.3 mm Ø
RM-1149-00-A	RM-1149-00-B	RM-1149-00-C	RM-1149-00-D	RM-1149-00-E

Fig. 3 / 4	Fig. 4 / 5	Fig. 5 / 6	Fig. 6 / 7	Fig. 7 / 8
1.3/ 1.4 mm Ø	1.4/ 1.5 mm Ø	1.5/ 1.6 mm Ø	1.6/ 1.8 mm Ø	1.8/ 1.9 mm Ø
RM-1149-01-A	RM-1149-01-B	RM-1149-01-C	RM-1149-01-D	RM-1149-01-E

zylindrisch

cylindrical

cyllindriques

cilindrico

cilindrico



Williams

Fig. 000 / 00	Fig. 00' 0	Fig. 0 / 1	Fig. 1 / 2	Fig. 2 / 3
0.4/ 0.6 mm Ø	0.7/ 0.8 mm Ø	0.8/ 0.9 mm Ø	0.9/ 1.1 mm Ø	1.1/ 1.3 mm Ø
RM-1149-02-A	RM-1149-02-B	RM-1149-02-C	RM-1149-02-D	RM-1149-02-E

Fig. 3 / 4	Fig. 4 / 5	Fig. 5 / 6	Fig. 6 / 7	Fig. 7 / 8
1.3/ 1.4 mm Ø	1.4/ 1.5 mm Ø	1.5/ 1.6 mm Ø	1.6/ 1.8 mm Ø	1.8/ 1.9 mm Ø
RM-1149-03-A	RM-1149-03-B	RM-1149-03-C	RM-1149-03-D	RM-1149-03-E

geknöpft

probe

boutonnés

botonado

botonuti



115 mm – 4½"	EG-1150-11-A	EG-1150-11-B
130 mm – 5"	EG-1150-13-A	EG-1150-13-B
145 mm – 5¾"	EG-1150-14-A	EG-1150-14-B
160 mm – 6¼"	EG-1150-16-A	EG-1150-16-B
180 mm – 7"	EG-1150-18-A	EG-1150-18-B
200 mm – 8"	EG-1150-20-A	EG-1150-20-B

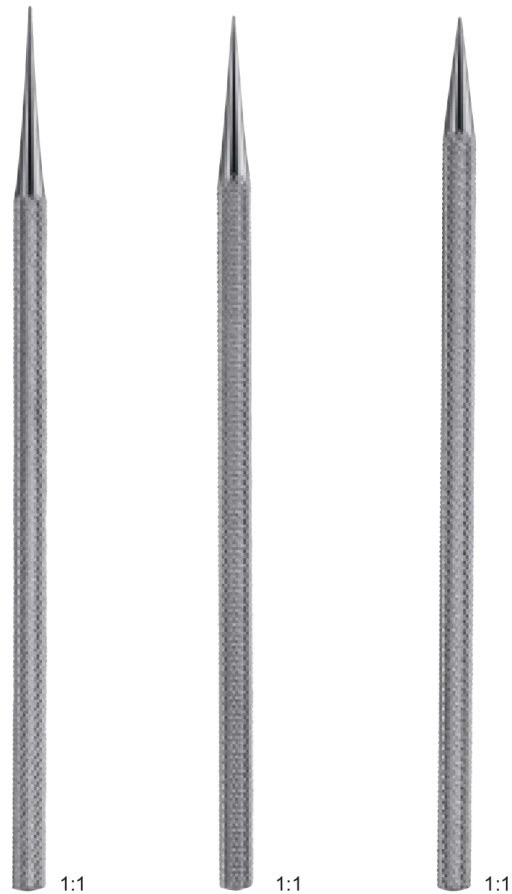

Wilder

EG-1150-00-A	EG-1150-00-B	EG-1150-00-C
---------------------	---------------------	---------------------

Tränenkanal-Dilatatoren

Lacrimal dilators

Dilatateurs pour le canal lacrymal

Dilatadores para el canal lacrimal

Dilatatori lacrimali

Bone Crushers



1:2



1:2

Cottle

EG-1151-00-A

Quetscher mit Klammer
bone crusher with clamp

broyeur avec pince
prensa para huesos
sciaccia cartilagine



1:2

EG-1151-00-B

Knorpelhalter
cartilage holding forceps
pince à saisir des cartilages
pinza para tener cartilagos
pinza fi ssa cartilagine



Cottle

EG-1151-00-C

Knochenmühle
bone mill
moulin d'os
molino de huesos
mulino per ossa



65 × 30 mm

Gubisch

EG-1151-00-D

Plastic Surgery

Ethmoid Bone Forceps

	Maulbreite Jaw width Ancho de boca Largeur de mors Larghezza dei morsi			
		a = 12 cm - 4 3/4"	a = 12 cm - 4 3/4"	a = 12 cm - 4 3/4"
# 1	3,0 mm	EG-1152-00-A	EG-1152-01-A	EG-1152-02-A
# 2	3,6 mm	EG-1152-00-B	EG-1152-01-B	EG-1152-02-B
# 3	4,2 mm	EG-1152-00-C	EG-1152-01-C	EG-1152-02-C
# 4	4,8 mm	EG-1152-00-D	EG-1152-01-D	EG-1152-02-D
# 5	5,6 mm	EG-1152-00-E	EG-1152-01-E	EG-1152-02-E

Weil-Blakesley

P₁₀
EG-1152-02

Feder
Pen
Pluma
Plume
Piuma

130 mm
EG-1152-01

Federhalter
Pen holder
Porta-plumas
Porte-plume
Porta-piuma

Gubisch

Plastic Surgery

Micro Blade Holder --- Micro Blades



A

drei Löcher, diagonal
three holes, diagonal
tres orifi cios, diagonal
trois trous, diagonal
tre fori, diagonale

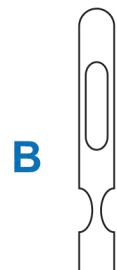

B

ein zentrales Loch
zwei laterale Löcher

one central hole
two lateral holes

un orifi cio central
dos orifi cios laterales

un trou central
deux trous latéraux

un foro centrale
due fori laterali

Ø 3,0 mm

Ø 4,0 mm

Ø 5,0 mm

Ø 6,0 mm



200 mm	300 mm	300 mm	300 mm
EG-1153-00-A	EG-1153-00-B	EG-1153-00-C	EG-1153-00-D
300 mm	300 mm		
EG-1153-00-E	EG-1153-00-F		

Ø 4,0 mm

Ø 5,0 mm



300 mm	300 mm
EG-1153-01-A	EG-1153-01-B



Handles for cannulas
EG-1153-02

Plastic Surgery

Breast Dissectors



EG-1154-01-A	EG-1154-01-B
360 mm	360 mm

Breast Dissectors

EG-1154-00-A	340 mm
EG-1154-00-B	370 mm

Breast Dissectors

EG-1154-02

Plastic Surgery

Breast Retractors

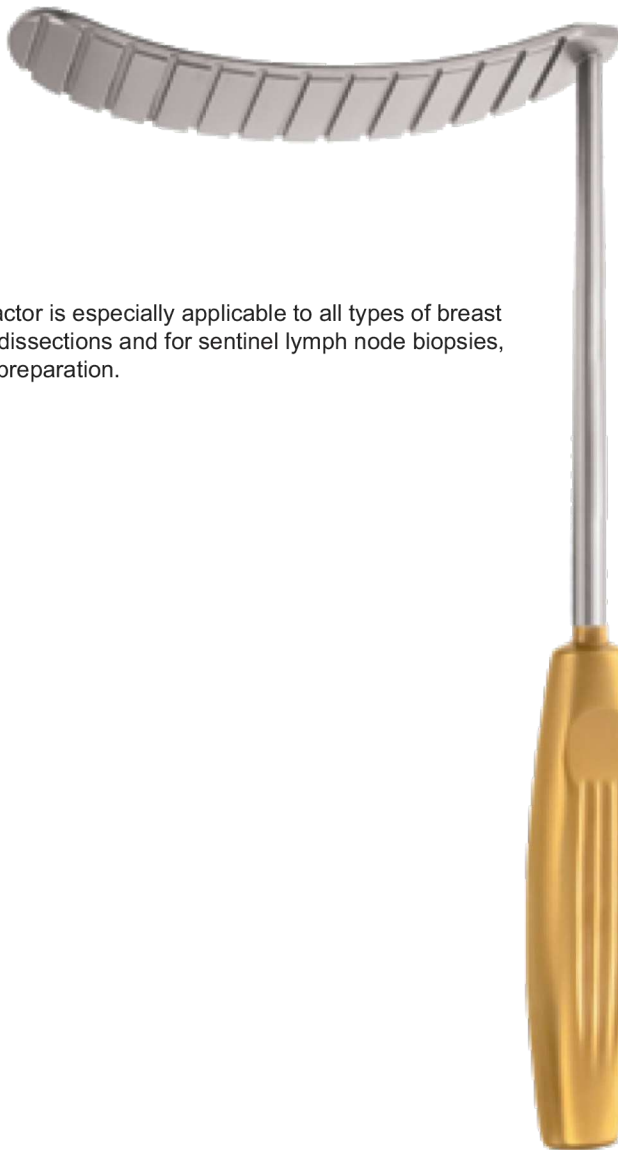
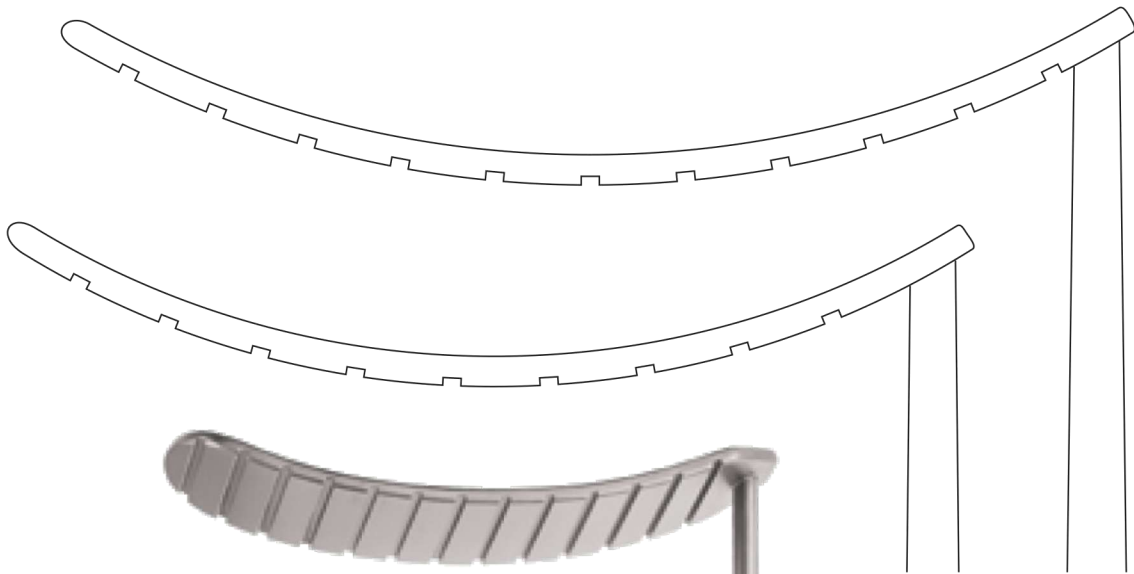

EG-1155-00-A	EG-1155-00-B
125 × 30 mm	140 × 30 mm
270 mm - 10¾"	270 mm - 10¾"

This curved retractor is especially applicable to all types of breast surgeries, axilla dissections and for sentinel lymph node biopsies, allowing a clear preparation.

Plastic Surgery

Abdominal Retractors for Lipoabdominoplasty

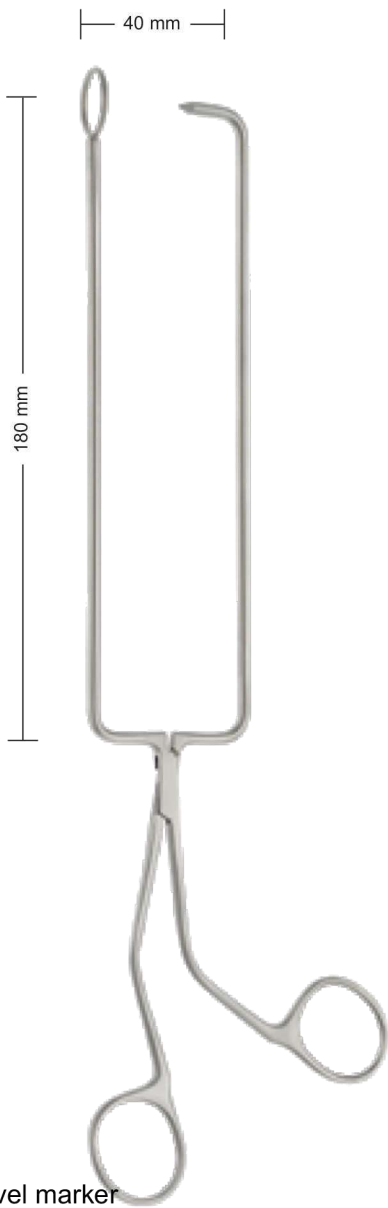

Navel marker
290 mm
EG-1156-01

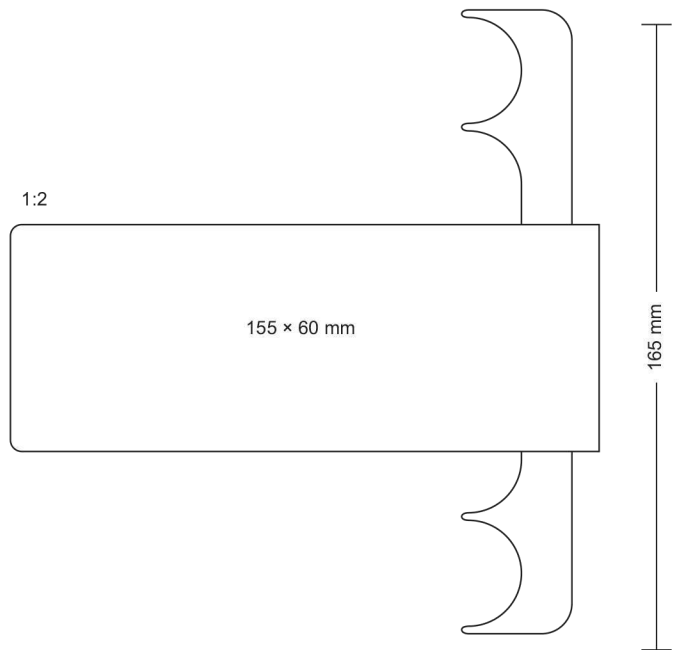

zerlegbar
dismantable
desmontable
démontable
smontabile

Saldanha-Solz
200 mm
EG-1156-00

Different Container



0.75 l	165 mm Ø x 60 mm	EG-1157-00
1.00 l	175 mm Ø x 70 mm	EG-1157-01
2.00 l	220 mm Ø x 80 mm	EG-1157-02
3.00 l	240 mm Ø x 110 mm	EG-1157-03
4.50 l	275 mm Ø x 115 mm	EG-1157-04
6.00 l	290 mm Ø x 125 mm	EG-1157-05
6.00 l	310 mm Ø x 120 mm	EG-1157-06
8.50 l	345 mm Ø x 125 mm	EG-1157-07
11.00 l	380 mm Ø x 130 mm	EG-1157-08

Schüsseln und Laborschalen, matt, 18/8 rostfrei
Bowls, tarnished, 18/8 stainless steel

Coupoles, depoli, 18/8 inoxidable
Palanganas, 18/8 inoxidable
Scodelle, inossidabile 18/8



0.05 l	40 mm Ø x 19 mm	EG-1157-09
0.07 l	61 mm Ø x 30 mm	EG-1157-10
0.14 l	80 mm Ø x 40 mm	EG-1157-11
0.35 l	116 mm Ø x 50 mm	EG-1157-12
0.45 l	128 mm Ø x 55 mm	EG-1157-13
0.70 l	147 mm Ø x 65 mm	EG-1157-14



170 mm x 95 mm x 25 mm	EG-1157-15
200 mm x 95 mm x 30 mm	EG-1157-16
250 mm x 125 mm x 35 mm	EG-1157-17
275 mm x 140 mm x 40 mm	EG-1157-18

Nierenschalen, matt, 18/8 rostfrei
Kidney bowls, tarnished, 18/8 stainless steel

Haricots, depoli, 18/8 inoxidable
Riñoneras, 18/8 inoxidable
Baccinella renifoEGe, 18/8 inossidabile



0,05 l	50mm Ø x 50 mm	EG-1157-19
--------	----------------	-------------------

Medizinbecher, graduert, matt, 18/8 rostfrei
Medicine cup, graduated, tarnished, 18/8 stainless steel

Timbale, graduée, depolie, 18/8 inoxidable
Vaso, graduado, mate, 18/8 inoxidable
Recipiente, graduato, 18/8 inossidabile

Plastic Surgery

Instruments Trays Make of Stainless Steel



Mit Deckel- und Bodenlochung mit Textil-Langzeitfiltern für Dampfsterilisation
With lid and bottom perforation with textil "LongteEG" filters for steam sterilisation
 Couvercle et boîtier perforé avec filtre en textile pour stérilisation à vapeur
Con perforación en tapa y fondo, con filtros en tejido para esterilización a vapor
 Con filtri tessili, per la sterilizzazione a vapore

Silikon-Andrückleisten zum Fixieren der Instrumente
Silicone protective strips for fixation of instruments

Tapis en silicone pour fixer les instruments
Tiras de silicon para fijar los instrumentos
 Righe di silicone per fissare gli strumenti

Silikon-Noppenstreifen zur schonenden Auflage der Instrumente
Silicon strips for a soft and protective storage of the instruments

Tapis en silicone pour la protection des instruments
Mata de silicon para proteger los instrumentos
 Stuoie di silicone per proteggere gli strumenti

1 herausnehmbare Siebplatte
1 removable tray insert
 1 tableau pour sortir
1 placa para sacar
 1 cestello

Kennzeichnungsschilder nach Wahl (Farbe und Text)
Marking plate for selection: colour and description

Plaque d'identification (texte et couleur selon demande)
Placas de identificación a opción (color y texto)
 Placche d'identificazione (colore a scelta)

280 x 195 x 55mm	265x 255 x 55mm	380x 260 x 55mm	200x 140 x 55mm	470x 250 x 55 mm
EG-1158-00-A	EG-1158-00-B	EG-1158-00-C	EG-1158-00-D	EG-1158-00-E



wärmeisolierende Halteknöpfe zum Herausheben
heatisolated handles

pins isolés pour sortir des tableaux
Pernos aislados para sacar las placas
 maniglia a forma di botone

2 herausnehmbare Siebplatten
2 removable tray inserts
 2 tableaux detachables
2 placas para sacar
 2 cestelli

Silikon-Andrückleisten an der Unterseite des Siebes
Silicone protective strips at the lower side of the tray
 Tapis de silicone à la partie inférieure des tableaux
Tiras de silicon a bajo de las placas
 Righe di silicone

280 x 195 x 65mm	265x 255 x 65mm	380x 260 x 65mm	200 x 140 x 65mm	470x 250 x 65 mm
EG-1158-01-A	EG-1158-01-B	EG-1158-01-C	EG-1158-01-D	EG-1158-01-E



Ramiraz Cobra Cannula

Stainless Steel. Designed to shield surrounding tissue
 Unique cobra shaped hood to aid in tissue elevation.
 Can be used with 4 mm or 5 mm endoscopes.
 Single Stop-Cock for 5 mm Scope
 Low Profile for 5 mm Scope Without Stop-Cock

EG-1159-01



Endoscopic Plastic Scope

Stainless Steel. Thirty degree rod lens. Steam autoclavable endoscope.

EG-1159-00-A

175 mm 5 mm Ø

EG-1159-00-B

175 mm 4 mm Ø

EG-1159-00-C

175 mm 10 mm Ø

EG-1159-00-D

330 mm 10 mm Ø

EG-1159-00-E

330 mm 10 mm Ø

Plastic Surgery

Endoscopic Plastic Instruments



Danial Forehead Cannula
Stainless Steel. Designed to shield surrounding tissue.

EG-1160-00



Fenestrated Forehead Cannula

Stainless Steel. Unique Fenestrated Hood intended for dissection and Greater Elevation. Designed to shield Surrounding Tissue

EG-1160-01-A

7 x 17 mm

EG-1160-01-B

12 x 23 mm



Inline Ergo Style Abdominal Needle Holders

EG-1160-02

320 mm

Cartilage Grid



EG-1161-00
a = 120 mm b = 85 mm
Front Side



Back Side

Plastic Surgery

Gonzallo Retractors



Gonzalez Detacher
 260 mm
EG-1162-01



gonzalez straight blade
 320 mm
 20 mm wide
EG-1162-02



320 mm
 30 mm wide
EG-1162-03



Gonzalez Retractors
 180 mm
 20 mm Wide
EG-1162-04

Gonzalez Retractors
 200 mm
EG-162-05

Plastic Surgery

Gubisch Rhinoplasty Set



EG-124-11-B



EG-118-12-B



EG-113-17-A



EG-113-14-A



EG-147-12-TC



EG-148-12-B1



EG-147-12-B1



EG-150-20-A1



EG-103-15T

EG-102-07-B

Item number	Description	Quantity
EG-103-15T	Scalpel blade · figure 15 · sterile · packing unit 100 pieces	1
EG-102-07-B	Scalpel handle · no. 7 · long · 16.5 cm	1
EG-124-11-B	Delicate scissors · straight · 12 cm	1
EG-118-12-B	Operating scissors · straight · sharp/blunt · 13 cm	1
EG-113-17-A	MAYO-STILLE HM Dissecting scissors · curved · 17 cm	1
EG-113-14-A	REYNOLDS (JAMESON) Dissecting scissors · curved · 14 cm	1
EG-147-12-TC	ADSON HM Dressing forceps · 12 cm	1
EG-148-12-B1	MICRO-ADSON Tissue forceps · 1 × 2 teeth · 12 cm	2
EG-147-12-B1	ADSON-BROWN Tissue forceps · 7 × 7 teeth · 12 cm	1
EG-150-20-A1	Dressing forceps · serrated · 20 cm	1

Plastic Surgery

Daniel Rhinoplasty Set



Plastic Surgery

Daniel Rhinoplasty Set



EG-191-11

EG-181-13-A

EG-1129-16-B

Item number	Description	Quantity
EG-103-15T	Scalpel blade sterile packing unit 100 pieces	1
EG-102-07-B	Scalpel handle · no. 7 · long · 16.5 cm	1
EG-113-14-A	REYNOLDS (JAMESON) Scissors · curved · 14 cm	1
EG-147-12-TC	ADSON HM Dressing forceps · 12 cm	1
EG-148-12-B1	MICRO-ADSON Tissue forceps · 1 × 2 teeth · 12 cm	2
EG-147-12-B1	ADSON-BROWN Tissue forceps · 7 × 7 teeth · 12 cm	1
EG-150-20-A1	Deuhrssen Dressing forceps · serrated · 20 cm	1
EG-152-17-C	Dressing forceps · 16 cm	1
EG-197-13	GUBISCH HM Needle holder · fine · 12.5 cm	1
EG-1100-14	CRILE-WOOD HM (DEBAKEY HM) Needle holder · fine · 15 cm	1
EG-168-12-B	MICRO-HALSTED Hemostatic forceps · curved · 12.5 cm	2
EG-1144-13	BACKHAUS Towel clamp · 13 cm	3
EG-175-25-A1	RAMPLEY Sponge forceps · straight · 24 cm	2
EG-187-16	RAGNELL Delicate retractor · double-ended · 16 cm	2
EG-191-11	CRILE Retractor · double-ended · 11 cm	1
EG-176-00	BARSKY Skin hook · 1 tooth · 15 cm	1
EG-177-16-B	JOSEPH Delicate retractor · 2 teeth · sharp · 17 cm	2
EG-181-13-A	GUTHRIE Delicate retractor · 2 teeth · sharp · 13 cm	2
EG-1129-16-B	WILLIGER Raspatory · 5 mm · 16 cm	1

Plastic Surgery

Gubisch Rhinoplasty Set



EG-1123-20-D



EG-1121-20-A



EG-1140-20



EG-173-16-B



EG-1137-15-A



EG-1137-15-B



EG-1137-00

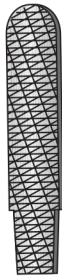

EG-1137-01 TO 10



EG-1140-21



EG-1125-14



EG-1135-00

Item number	Description	Quantity
EG-1121-20-A	GUBISCH Osteotome · with aluminium handle · 2 mm · 18.5 cm	1
EG-1121-20-B	GUBISCH Osteotome · with aluminium handle · 3 mm · 18.5 cm	1
EG-1123-20-D	FANOUS-GUBISCH Osteotome · with thorn · 4 mm · 19.5 cm	1
EG-1140-20	CAPLAN Nasal septum scissors · angled · 20 cm	1
EG-173-16-B	AIACH-GUBISCH Forceps · 16 cm	1
EG-173-16-C	AIACH-GUBISCH Forceps · 16 cm	1
EG-1137-15-A	Handle for nasal rasps · 14 cm	1
EG-1137-15-B	Handle for nasal rasps · double-ended · 14 cm	1
EG-1137-00	Wrench · for nasal rasps	1
EG-1137-02	Rasps insert HM · figure 2	1
EG-1137-05	Rasps insert HM · figure 5	1
EG-1137-01	Rasps insert HM · figure 1	1
EG-1137-03	Rasps insert HM · figure 3	1
EG-1137-04	Rasps insert HM · figure 4	1
EG-1137-06	Rasps insert HM · figure 6	1
EG-1137-07	Rasps insert HM · figure 7	1
EG-1137-08	Rasps insert HM · figure 8	1
EG-1137-09	Rasps insert HM · figure 9	1
EG-1137-10	Rasps insert HM · figure 10	1
EG-1140-01	Protective guard	1
EG-1140-21	GUBISCH-RUBIN HM Septal morselizer · 20 cm	1
EG-1125-14	LINDEMANN Cutting burr · shank-Ø 2.35 mm · 45 mm	1
EG-1125-14	LINDEMANN Cutting burr · shank-Ø 2.35 mm · 44.5 mm · Ø 1.4 mm	1
EG-1125-14	LINDEMANN Cutting burr · shank-Ø 2.35 mm · 70 mm · Ø 1.4 mm	1
EG-1135-00	BUCHWALD Tongue spatula · 18/23 mm · 18 cm	1

Plastic Surgery

Gubisch Rhinoplasty Set



EG-1135-01



EG-1125-07

EG-182-16-A3



EG-1134-13-B1



EG-1130-16



EG-1141-16



EG-1141-31



EG-179-10



EG-1120-19-A



EG-1132-16



EG-1152-00-C



EG-1151-00-D



EG-1136-17-A

Item number	Description	Quantity
EG-1135-01	CASTROVIEJO Caliper · measuring range 20 mm · 8 cm	1
EG-182-16-A3	DESMARRES Lid retractor · figure 2 · 14 cm	1
EG-1125-07	Cutting burr · barrel style · Ø 5 mm · shank Ø 2.35 mm · 7 cm	1
EG-1134-13-B1	KILLIAN Nasal speculum · figure 4 · 90 mm · dismantable · 14 cm	1
EG-1152-00-C	WEIL-BLAKESLEY Nasal forceps · straight · 4.2 mm · 12 cm	1
EG-1130-16	FREER Mucosa knife · 16 cm	1
EG-1132-16	COTTLE Nasal speculum · 50 mm · 13 cm	1
EG-1141-16	HARALDSSON Suction elevator · Ø 3 mm · 18.5 cm	1
EG-1141-31	DANIEL Spina nasalis awl · 16 cm	1
EG-1151-00-D	COTTLE Cartilage crusher	1
EG-179-10	GUBISCH-KILNER Alar retractor · 10 mm · 8 cm	1
EG-1136-17-A	GUBISCH-AUFRICHT Nasal retractor · 17 cm · 30 × 6/10 mm	1
EG-1136-17-B	GUBISCH-AUFRICHT Nasal retractor · 17 cm · 50 × 6/12 mm	1
EG-1120-19-A	COTTLE-GUBISCH Chisel · graduated · hollow cut · 5 mm · 18 cm	1
EG-1120-19-B	COTTLE-GUBISCH Chisel · graduated · hollow cut · 12 mm · 18 cm	1

Plastic Surgery

Gubisch Rhinoplasty Set



Item number	Description	Quantity
EG-158-23	NELSON Tissue grasping forceps · 15 cm	1
EG-152-17-C	GRUENWALD Bayonet forceps · 16 cm	1
EG-197-13	GUBISCH HM Needle holder · extra-fine · 12.5 cm	1
EG-197-15-TC	CRILE-WOOD HM Needle holder · fine · 15 cm	1
EG-168-12-A	MICRO-HALSTED Hemostatic forceps · straight · 12.5 cm	1
EG-168-12-B	MICRO-HALSTED Hemostatic forceps · curved · 12.5 cm	1
EG-171-15-A	LERICHE Hemostatic forceps · straight · 15 cm	1
EG-170-14-A1	PEAN Hemostatic forceps · straight · 14 cm	2
EG-1144-13	BACKHAUS Towel clamp · 13 cm	1
EG-176-15-A	Dressing forceps · curved · 17.5 cm	1
EG-175-15-B	GROSS Dressing forceps · curved · 20 cm	1
EG-170-00	BARSKY Skin hook · 1 tooth · 15 cm	2
EG-177-16-B	JOSEPH Delicate retractor · 2 teeth · 17 cm	1
EG-181-13	GUTHRIE Delicate retractor · 2 teeth · sharp · 13 cm	1
EG-1130-20-A	LANGENBECK Elevator · thin · 7 mm · 20 cm	1
EG-1129-19-C	FREER Raspatory · sharp/sharp · 5 mm · 19 cm	1
EG-1129-16-B	WILLIGER Raspatory · 5 mm · 16 cm	1
EG-1126-15-A	McKENTY Raspatory · 3 mm · 15 cm	1
EG-1126-15-B	McKENTY Raspatory · 4 mm · 15 cm	1
EG-1115-26	Mallet · made of Novotex plastic · Ø 45 mm · 240 g · 26 cm	1
EG-1152-01	GUBISCH Pen holder · 13 cm	1
EG-1152-02	Pen · for pen holder 44.90.70 · packing unit 10 pieces	1
EG-2287-09	Round bowl · Ø 40 mm · height 20 mm · 0.02 l	1
EG-2287-10	Round bowl · Ø 60 mm · height 30 mm · 0.06 l	1
EG-2287-11	Round bowl · Ø 80 mm · height 40 mm · 0.16 l	1
EG-2287-12	Round bowl · Ø 110 mm · height 55 mm · 0.40 l	1

Plastic Surgery

Daniel Rhinoplasty Set



EG-1126-15-A



EG-1115-26



EG-106-04



EG-1157-10



EG-1157-19



EG-1135-01



EG-1132-16



EG-1141-16



EG-1126-15-A

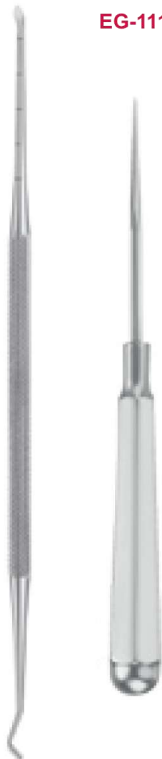

EG-1126-15-A



EG-1126-15-A



EG-1151-00-D



EG-193-11



EG-1121-20-A



EG-1120-17



EG-1123-20-D

Item number	Description	Quantity
EG-1126-15-A	McKENTY Raspatory · 3 mm · 15 cm	1
EG-1115-26	Mallet · made of Novotex plastic · Ø 45 mm · 240 g · 26 cm	1
EG-179-00-A	Ruler · graduated in mm and inches · 15 cm	1
EG-153-10	Round bowl · Ø 60 mm · height 30 mm · 0.06 l	1
EG-153-12	Round bowl · Ø 110 mm · height 55 mm · 0.40 l	1
EG-153-19	Medicine cup · graduated · 50 cc	1
EG-1135-01	CASTROVIEJO Caliper · measuring range 20 mm · 8 cm	1
EG-1132-16	COTTLE Nasal specula · 50 mm · 13 cm	1
EG-1141-16	HARALDSSON Suction elevator · Ø 3mm · 18.5 cm	1
EG-1125-20	DANIEL-CAKIR Subperichondrial/subperiosteal elevator · 20 cm	1
EG-1127-21	COTTLE-DANIEL Septal elevator · 21 cm	1
EG-1141-31	DANIEL Spina nasalis awl · 16 cm	1
EG-1151-00-D	GUBISCH Cartilage crusher · 65 × 30 mm	1
EG-179-10	GUBISCH-KILNER Alar retractor · 10 mm · 8 cm	1
EG-193-11	AUFRIECHT-DANIEL Nasal retractor · 11 cm	1
EG-1121-20-A	GUBISCH Osteotome · straight · 2 mm · 18.5 cm	1
EG-1121-20-B	GUBISCH Osteotome · straight · 3 mm · 18.5 cm	1
EG-1120-17	CAKIR Osteotome · straight · without guide	1
EG-1123-20-D	FANOUS-GUBISCH Osteotome · with guide · 3 mm · 19.5 cm	1

Plastic Surgery

Gubisch Rhinoplasty Set



EG-124-11-A



EG-117-14-A-SU



EG-110-03-B



EG-114-16-B



EG-137-18



EG-136-13

Item number	Description	Quantity
EG-124-11-A	SC Plus iris scissors straight · 11.5 cm	1
EG-117-14-A-SU	MAYO Dissecting scissors · supercut plus · straight · 14 cm	1
EG-117-17-B-SU	MAYO Dissecting scissors · supercut plus · curved · 17 cm	1
EG-110-03-B	METZENBAUM Dissecting scissors · supercut plus · curved · 18 cm	1
EG-114-16-B	KELLY Dissecting scissors · supercut plus · curved · 16 cm	1
EG-137-18	HEYMANN Rhinoplasty scissors · supercut · 18 cm	1
EG-136-13	FOMON Rhinoplasty scissors · supercut plus · angled downwards · 13 cm	1

Plastic Surgery

Face and Forehead Lift Instruments Set



EG-148-12-B1



EG-147-12-B1



EG-151-20-A



EG-1153-02



EG-197-13



EG-198-15-TC



EG-179-01-A



EG-103-15T

EG-102-07-B



EG-1144-13-A

EG-1153-00-A



EG-177-16-B



EG-190-18-C



EG-189-19



EG-192-21-E

Plastic Surgery

Face and Forehead Lift Instruments Set

Item number	Description	Quantity
EG-103-15T	Scalpel blade · figure 15 · sterile · packing unit 100 pieces · sterile	1
EG-102-07-B	Scalpel handle · no. 7 · long · 16.5 cm	1
EG-148-12-B1	MICRO-ADSON Tissue forceps · 1 × 2 teeth · 12 cm	1
EG-147-12-B1	ADSON-BROWN Tissue forceps · 7 × 7 teeth · 12 cm	1
EG-151-20-A	SELECT Tissue forceps · 1 × 2 teeth · 20 cm	1
EG-1153-00-A	Liposuction cannula · Ø 3.0 mm · three holes · diagonal · 20 cm	1
EG-1153-02	Handle for cannula · with hole · tube connection · rotatable · 13 cm	1
EG-197-17	GUBISCH HM Needle holder · extra-fine · 12.5 cm	1
EG-198-15-TC	BABY CRILE-WOOD HM Needle holder · fine · 15 cm	1
EG-1144-13-A	BACKHAUS Towel clamp · 8.5 cm	6
EG-179-01-A	GILLIES Delicate retractor · 1 tooth · 19 cm	1
EG-177-16-B	JOSEPH Delicate retractor · 2 teeth · 17 cm	1
EG-190-18-C	FARABEUF-BABY Retractor · double-ended · 10/12 mm · 12 cm	1
EG-189-19	WALTER Retractor · double-ended · 19 cm	1
EG-192-21-E	LANGENBECK-KOCHER Retractor · 15 × 80 mm · 21 cm	2
EG-1153-00-A	SOLZ Racket retractor · 45 × 100 mm · 12.5 cm	2
EG-1153-00-A	DEMARTEL Scalp flap forceps · 14 cm	1

Blepharoplasty Set



EG-102-07-B



EG-128-11-A



EG-147-12-A



EG-148-15-A1



EG-1102-12



EG-164-15-A1



EG-179-01-A



EG-177-16



EG-103-15T



EG-182-16-A1



EG-182-16-C2



EG-117-14-B-SU



EG-1144-13-A

Item number	Description	Quantity
EG-103-15T	Scalpel blade · fi gure 15 · sterile · packing unit 100 pieces	1
EG-102-07-B	Scalpel handle · no. 3 · 12.5 cm	1
EG-128-11-A	STEVENS Delicate scissors · straight · sharp · 11.5 cm	1
EG-128-11-B	STEVENS Delicate scissors · curved · sharp · 11.5 cm	1
EG-147-12-A	ADSON Dressing forceps · serrated · 12 cm	1
EG-148-15-A1	ADSON Dressing forceps · serrated · 12cm	1
EG-1102-12	NEIVERT Needle holder · smooth · 12.5 cm	1
EG-164-15-A1	HALSTED-MOSQUITO Hemostatic forceps · straight · 12.5 cm	1
EG-164-15-B1	HALSTED-MOSQUITO Hemostatic forceps · curved · 12.5 cm	1
EG-1144-13-A	BACKHAUS Towel clamp · 8.5 cm	4
EG-179-01-A	GILLIES Delicate retractor · 1 tooth · 19 cm	1
EG-177-16	JOSEPH Delicate retractor · 2 teeth · 17 cm	1
EG-182-16-A1	JOSEPH Delicate retractor · 2 teeth · blunt · 16 cm	1
EG-182-16-C2	DESMARRES Lid retractor · fi gure 1 · 9 × 12 mm · 13 cm	1
EG-117-14-B-SU	MAYO Dissecting scissors · supercut · straight · 14 cm	1

Plastic Surgery

Daniel Rhinoplasty Set



Item number	Description	Quantity
EG-1137-15-B	Handle for nasal rasps · double-ended · 14 cm	1
EG-1137-00	Wrench · for nasal rasp	1
EG-1137-05	HM Nasal rasps · figure 5	1
EG-1137-06	HM Nasal rasps · figure 6	1
EG-117-17-A-SU	MAYO Dissecting scissors · supercut plus · straight · 17 cm	1
EG-136-15	DANIEL Dissecting scissors · black line · straight · 15 cm	1
EG-138-15-A	JOSEPH-DANIEL Dissecting scissors · black line · curved · blunt · 15 cm	1
EG-138-15-B	JOSEPH-DANIEL Dissecting scissors · black line · curved · sharp · 15 cm	1
EG-128-09	CONVERSE-DANIEL Dissecting scissors · black line · blunt · 9.5 cm	1

Plastic Surgery

Face and Forehead Lift Instruments Sets



EG-163-55



EG-124-11-B



EG-117-14-B-SU



EG-140-20-A-SU

Item number	Description	Quantity
EG-163-55	Tissue and Intestinal Holding Forceps · 16 cm	1
EG-124-11-B	Iris scissors · supercut · curved · 12.5 cm	1
EG-117-14-B-SU	MAYO Dissecting scissors · supercut · straight · 14 cm	1
EG-140-20-A-SU	SOLZ Dissecting scissors · supercut · curved · 20 cm	1
EG-140-20-B-SU	SOLZ Dissecting scissors · supercut · curved · 20 cm	1

Plastic Surgery

Mammoplasty Instruments Set



EG-124-13-B



EG-110-04-B

EG-148-13-B



EG-152-17-C



EG-198-15-TC



EG-190-18-C



EG-192-21-E



EG-103-15T



EG-102-07-B



EG-1154-00-A



EG-1154-01-A



EG-1155-00-A



EG-1157-12



EG-106-00-A



EG-140-20-A-SU

Item number	Description	Quantity
EG-103-15T	Scalpel blade · fi gure 15 · sterile · packing unit 100 pieces	1
EG-102-07-B	Scalpel handle · no. 7 · long · 16.5 cm	1
EG-124-13-B	JABALEY Delicate scissors · standard · curved · 13 cm	1
EG-110-04-B	METZENBAUM Dissecting scissors · curved · 20 cm	1
EG-148-13-B	MICRO-ADSON Tissue forceps · 1 × 2 teeth · 12 cm	1
EG-152-17-C	GRUENWALD Bayonet forceps · 19.5 cm	1
EG-198-15	BABY CRILE-WOOD Needle holder · fi ne · 15 cm	1
EG-198-15-TC	BABY CRILE-WOOD HM Needle holder · fi ne · 15 cm	1
EG-190-18-C	FARABEUF-BABY Retractor · double-ended · 10/12 mm · 12 cm	1
EG-192-21-E	LANGENBECK-KOCHER Retractor · 15 × 80 mm · 21 cm	1
EG-1154-00-A	SOLZ Non-traumatical breast dissector · 34 cm	1
EG-1154-00-B	SOLZ Non-traumatical breast dissector · 37 cm	1
EG-1154-01-A	SOLZ Hook dissector · right angled · 36 cm	1
EG-1154-01-B	SOLZ Hook dissector · left angled · 36 cm	1
EG-106-00-B	SOLZ Areola marker · blunt · Ø 36 mm	1
EG-106-00-C	SOLZ Areola marker · blunt · Ø 40 mm	1
EG-106-00-D	SOLZ Areola marker · blunt · Ø 42 mm	1
EG-106-00-E	SOLZ Areola marker · blunt · Ø 45 mm	1
EG-1155-00-A	MARX Breast retractor · 125 × 30 mm · 27 cm	1
EG-1155-00-B	MARX Breast retractor · 140 × 30 mm · 27 cm	1
EG-157-12	Bowl for marking colour · 0.06 l · Ø 6 cm	1
EG-140-20-A-SU	SOLZ Dissecting scissors · supercut · curved · 20 cm	1
EG-140-20-B-SU	SOLZ Dissecting scissors · supercut · curved · 20 cm	1

Plastic Surgery

Daniel Gubisch Rib Harvest Set



EG-103-10T



10

EG-102-03-A



EG-118-12-B



EG-146-15-A



EG-147-12-B1



EG-153-15-A



EG-1100-18-A-TC



EG-186-19-A



EG-1157-00



EG-190A-17-A



EG-190A-17-B



EG-190A-17-C



EG-178-17-A



EG-190A-18-A



EG-190A-18-B

Item number	Description	Quantity
EG-103-10T	Scalpel blade · figure 10 · sterile · packing unit 100 pieces	1
EG-102-03-A	Scalpel handle · no. 3 · standard · 12.5 cm	1
EG-118-12-B	Operating scissors · straight · sharp/blunt · 14.5 cm	1
EG-146-15-A	Tissue forceps · straight · slim · 1 x 2 teeth · 14.5 cm	1
EG-147-12-B1	ADSON-BROWN Tissue forceps · straight · 7 x 7 teeth · 12 cm	1
EG-153-15-A	Russian tissue forceps · 15 cm	1
EG-1100-18-A-TC	MAYO-HEGAR HM Needle holder · 18 cm	1
EG-186-19-A	STRANDELL-STILLE Retractor · 6 x 15 mm · 17 cm	2
EG-190A-18-A	PARKER-LANGENBECK (US AEGY) Retractor · double-ended · 21 cm · set/2	1
EG-190A-18-B	PARKER-LANGENBECK (US AEGY) Retractor · double-ended · serrated · 21 cm · set/2	1
EG-190A-17-A	DANIEL-GUBISCH Raspatory · 6 mm · sharp · slight curved · 17.5 cm	1
EG-190A-17-B	DANIEL-GUBISCH Raspatory · 6 mm · sharp · medium curved · 17 cm	1
EG-190A-17-C	DANIEL-GUBISCH Raspatory · 6 mm · sharp · strong curved · 16 cm	1
EG-157-00	Round bowl · Ø 60 mm · height 30 mm · 60 ml	1
EG-157-01	Round bowl · Ø 80 mm · height 40 mm · 160 ml	1
EG-157-02	Round bowl · Ø 110 mm · height 55 mm · 400 ml	1
EG-178-17-A	DANIEL-GUBISCH Rib raspatory · right · 5 mm · sharp · 17 cm	1
EG-178-17-B	DANIEL-GUBISCH Rib raspatory · left · 5 mm · sharp · 17 cm	1

Plastic Surgery

Nagata Harvesting of Coastal Cartilages



Item number	Description	Quantity
EG-146-15-B	McINDOE Dressing forceps · 15 cm	1
EG-146-15-A	GILLIES Tissue forceps · 1 × 2 teeth · 15 cm	1
EG-186-16-B	SENN-MILLER Delicate retractor · double-ended · blunt · 16 cm	2
EG-181-17-B	JACKSON Delicate retractor · double-ended · blunt · 18 cm	2
EG-177-15-B	JOSEPH Delicate retractor · 16 cm	1
EG-192-21-B	LANGENBECK Retractor · 10 × 40 mm · 21 cm	2
EG-179-24	COHEN Elevator · double-ended · 5 mm · 24 cm	1
EG-182-20	PENNINGTON Septum elevator · double-ended · 20 cm	1
EG-178-18	DINGMAN Raspatory · double-ended · 18 cm	1
EG-117-14-B-SU	MAYO Delicate scissors · supercut · curved · 14 cm	1

Plastic Surgery

Daniel Gubisch Rib Harvesting Set



EG-153-15-A **EG-186-19-A** **EG-190A-18-A** **EG-190A-18-B** **EG-190A-17-A** **EG-190A-17-B** **EG-190A-17-C** **EG-178-17-A** **EG-181-21**

Item number	Description	Quantity
EG-153-15-A	Russian tissue forceps · 15 cm	1
EG-186-19-A	STRANDELL-STILLE Retractor · 6 x 15 mm · 17 cm	2
EG-190A-18-A	PARKER-LANGENBECK (US AEGY) Retractor · double-ended · 21 cm · set/2	1
EG-190A-18-B	PARKER-LANGENBECK (US AEGY) Retractor · double-ended · serrated · 21 cm · set/2	1
EG-190A-17-A	DANIEL-GUBISCH Raspatory · 6 mm · sharp · slight curved · 17.5 cm	1
EG-190A-17-B	DANIEL-GUBISCH Raspatory · 6 mm · sharp · medium curved · 17 cm	1
EG-190A-17-C	DANIEL-GUBISCH Raspatory · 6 mm · sharp · strong curved · 16 cm	1
EG-178-17-A	DANIEL-GUBISCH Rib raspatory · right · 5 mm · sharp · 17 cm	1
EG-181-21	DANIEL-GUBISCH Raspatory · double-ended · 4 mm · sharp/abrasive · 21.5 cm	1

Plastic Surgery

Abdominoplasty Set



EG-103-15T



EG-103-21T



EG-102-04

EG-102-07-B



EG-120-13



EG-148-15-A1

EG-147-12-C1



EG-140-20-A-SU



EG-151-21-A



EG-197-12



EG-1100-16-A-TC



EG-1156-00



EG-1144-13-A



EG-177-16-D



EG-190-18-C



EG-1156-01



EG-128-11-B1-SU



EG-117-14-B-SU



EG-130-23-B-SU

Item number	Description	Quantity
EG-103-15T	Scalpel blade · figure 15 · sterile · packing unit 100 pieces	1
EG-103-21T	Scalpel blade · figure 21 · sterile · packing unit 100 pieces	1
EG-102-07-B	Scalpel handle · no. 7 · long · 16.5 cm	1
EG-102-04	Scalpel handle · no. 4L · 21 cm	1
EG-120-13	RAGNELL (KILNER) Delicate dissecting scissors · curved · 13 cm	1
EG-148-15-A1	ADSON Tissue forceps · 1 × 2 teeth · 15 cm	1
EG-147-12-C1	ADSON-BROWN Tissue forceps · 9 × 9 teeth · 12 cm	1
EG-151-21-A	POTTS-SMITH Tissue forceps · 1 × 2 teeth · 21 cm	1
EG-151-25-A	ADSON Tissue forceps · 1 × 2 teeth · 25 cm	1
EG-197-12	WRIGHT (DERF) HM Needle holder · fine · 12.5 cm	2
EG-1100-16-A-TC	MAYO-HEGAR HM Needle holder · fine · 15 cm	2
EG-1100-24-A-TC	MAYO-HEGAR HM Needle holder · fine · 23 cm	2
EG-1144-13-A	BACKHAUS Towel clamp · 8.5 cm	6
EG-177-16-D	JOSEPH Delicate retractor · 2 teeth · 10 mm · sharp · 17 cm	2
EG-190-18-C	FARABEUF-BABY Retractor · double-ended · 10/12 mm · 12 cm	1
EG-1156-00	SALDANHA-SOLZ Abdominal retractor · 37 cm	1
EG-1156-01	SOLZ Navel marker · dismantable · 29 cm	1
EG-128-11-B1-SU	STEVENS Delicate scissors · supercut · curved · 11.5 cm	1
EG-117-14-B-SU	MAYO Dissecting scissors · supercut · straight · 14 cm	1
EG-130-23-B-SU	GORNEY Dissecting scissors · supercut · curved · 23 cm	1
EG-140-20-A-SU	SOLZ Dissecting scissors · supercut · curved · 20 cm	1
EG-140-20-B-SU	SOLZ Dissecting scissors · supercut · curved · 20 cm	1

Plastic Surgery

Nagata Articular Reconstruction with Coastal Cartilages



EG-147-12-A



EG-148-15-A1



EG-146-15-A



EG-146-15-B



EG-1104-11



EG-199-17A-TC



EG-139-12



EG-169-12-A



EG-164-15-B1

Item number	Description	Quantity
EG-147-12-A	ADSON Dressing forceps · serrated · 12 cm	2
EG-148-15-A1	ADSON Tissue forceps · 1 × 2 teeth · 12 cm	2
EG-146-15-B	McINDOE Dressing forceps · serrated · 15 cm	1
EG-146-15-A	GILLIES Tissue forceps · 1 × 2 teeth · 15 cm	1
EG-1104-11	NAGATA HM Needle holder · smooth · 11.5 cm	2
EG-199-17A-TC	MATHIEU HM Needle holder · regular · 17 cm	2
EG-139-12	UNIVERSAL HM Wire cutting scissors · serrated cutting edge · 12 cm	2
EG-169-12-A	NIRO HM Wire twisting forceps · 15 cm	2
EG-164-15-B1	HALSTED-MOSQUITO Hemostatic forceps · curved · 12.5 cm	2

Plastic Surgery

Nagata Articular Reconstruction with Coastal Cartilages



EG-1124-16



EG-1125-00

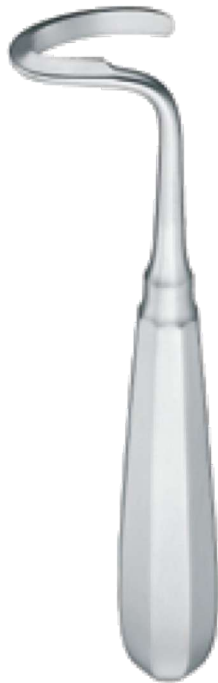

EG-178-00-A



EG-178-00-B



EG-125-10-A

Item number	Description	Quantity
EG-1124-16	NAGATA Septum elevator · blunt · double-ended · 16 cm	1
EG-1125-00	NAGATA Septum elevator · blunt · double-ended · 17 cm	1
EG-178-00-A	DOYEN Rip raspatory · right · 17 cm	1
EG-178-00-B	DOYEN Rip raspatory · left · 17 cm	1
EG-125-10-A	Delicate dissecting scissors · supercut · straight · 12 cm	2

Plastic Surgery

Kasten Preparation of Skin Graft



EG-145-15-A EG-146-15-A



EG-1100-24-A-TC



EG-1103-18-A-TC



EG-164-14-B1



EG-181-13-B

EG-105-03



EG-125-10-B-SU



EG-122-18-A-SU

Item number	Description	Quantity
EG-145-15-A	Dressing forceps · 14.5 cm	1
EG-146-15-A	Tissue forceps · 1 × 2 teeth · 14.5 cm	1
EG-1100-24-A-TC	MAYO-HEGAR HM Needle holder · noEGal · 20 cm	1
EG-1103-18-A-TC	MICRO-SLIM HM Needle holder · fi ne · 18 cm	1
EG-164-14-B1	HALSTED-MOSQUITO Hemostatic forceps · curved · 14 cm	4
EG-181-13-B	GUTHRIE Delicate retractor · 2 teeth · sharp · 13 cm	1
EG-105-03	Spare blade · packing unit 10 pieces · 6.5 cm	1
EG-125-10-B-SU	Delicate dissecting scissors · supercut plus · curved · 12 cm	1
EG-122-18-A-SU	METZENBAUM Dissecting scissors · supercut plus · curved · 18 cm	1

Plastic Surgery

Checking Sets

Wir bieten Krankenhäusern den Service von Siebsichtungen an. Leistungsumfang der Siebsichtung:

- Erfassung des gesamten Instrumentariums nach Quantität und Wert
- Standardisierung der Siebe respektive Ergänzung fehlender Instrumente
- Austausch oder Reparatur defekter Instrumente
- Erstellung von Übersichts- und Packlisten

the set checking includes:

We offer a set checking service for hospitals. Our performance of

- Record of all instruments according to quantity and value
- Standardization of the sets and completion of missing instruments respectively
- Exchange or repair of defective instruments
- Compilation of summary or packing lists

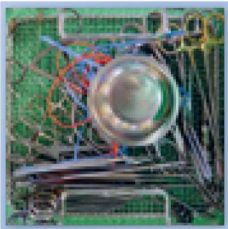

Nosotros ofrecemos para hospitales un servicio de revisión del instrumental quirúrgico. Contenido del servicio:

- Registro de todos los instrumentos según cantidad y valor
- Estandarizar los set instrumentales y completar los instrumentos faltantes
- Cambio o reparación de instrumentos defectos
- Elaboración de listas de contenido y empaque

Nous offrons aux hôpitaux un service de contrôle des boîtes. Le contrôle des boîtes contient:

- Enregistrement et chiffrage de l'instrumentation complète selon quantité et valeur
- Standardisation des boîtes ou complément d'instruments manquants
- Echange ou réparation des instruments défectueux
- Mise en place de listes de contenu et d'emballage

Offriamo un servizio di verifica dei set chirurgici per gli ospedali. Interventi nella verifica dei set chirurgici:

- Raccolta dello strumentario secondo quantità e valore
- Standardizzazione dei set attraverso l'aggiunta di strumenti mancanti
- Sostituzione o riparazione degli strumenti difettosi
- Elaborazione di un elenco del contenuto e dell'imballaggio

Index

.....50	COTTLE bone crusher	151
.....47, 48	COTTLE chisels	117, 118, 120
.....72	COTTLE elevators	124-127
.....48	COTTLE nasal rasp	136
.....48	COTTLE nasal specula	133-134
.....74	COTTLE trachea hooklets	76, 77, 79, 80
.....71	COTTLE-KAZANJIAN bone cutting forceps	148
.....74	COTTLE-NEIVERT nasal hooklet	80
.....74	COTTLE-WALSHAM septum forceps	139
.....87	Cotton swab und sponge holding forceps	75
.....45-52	CRILE haemostatic forceps	70
.....60	CRILE haemostatic forceps.....	65
.....61	CRILE nasal hooks	77
.....06	CRILE-MURRAY needle holder	97
.....139	CRILE-RANKIN haemostatic forceps	70
.....53-55	CRILE-RANKIN haemostatic forceps.....	65
.....78	CRILE-WOOD needle holders	97
.....136	CUSHING dressing forceps	45
.....33	DANDY haemostatic forceps	69
.....63	DAVIS face-lift scissors	35
.....73	DE BAKEY atraumatic forceps	54, 55
.....98	DE BAKEY BAYONET atraumatic forceps	53
.....11	DE Bakey needle holders	103
.....73	DE BAKEY-GERALD atraumatic forceps	53
.....124	DERF needle holders	97
.....109	DeEGatomes	4-5
.....106	DESMARRES retractor	82
.....02	DIETHRICH needle holders	105
.....95	Dissecting forceps - Dressing forceps	45-52
.....34	Dissecting scissors.....	17-23
.....147	DUEHRSEN dressing forceps	50
.....38-40	Face-lift scissors	35-36
.....145	FERREIRA mamaplasty retractors	84
.....37	FERREIRA retractors.....	91
.....148	Fine scissors	25-27
.....146	FISCHER tendon strippers	142
.....151	FOERSTER (BALLENGER) sponge holding forceps	75
.....148	FOMON chisels	119
.....145-147	FOMON nasal hooklet	76, 80
.....38	FOMON nasal rasps	137-138
.....149	FOMON nasal scissors	37
.....143	Forceps	45-58
.....20	Forceps, atraumatic	53-55
.....51	Forceps, micro-	56-58
.....141, 142	FOSTER-GILLIES needle holders	101
.....140	FREEMAN areola markers	6
.....144	FREEMAN retractors	88-89, 91
.....36	FREEMAN-KAYE scissors	33
.....43	FREER elevators	125, 127
.....107	FRIEDMAN bone rongeur.....	145
.....106	GALLAHER nasal rasps	137
.....06	GERALD dressing forceps	52
.....117-123	GILLIES dissecting forceps	46
.....119	GILLIES nasal hooklet	76
.....112	GILLIES needle holders	101
.....78	GOLDMAN-FOX scissors	
.....27	GORNEY PLATYSMA scissors	
.....90	GORNEY retractors.....	
	GORNEY scissors	
	GORNEY-DELICATE scissors	

Index

ALVIEXPO FREEMAN scissors	31	LOCKLIN scissors	26
ARMSTRONG RADLE scissors	25	LOCKWOOD tissue holding forceps	74
GRAEFER forceps	49	LUCAS mallets	116
GREENBERG PAR scissors	39	LUKENS trachea hooklet	81
GREGORY scissors	36	MACCOLLUM-DINGMAN mamaplasty retractor	84
GROSSMAN areola marker	6	Mallets	115-116
Haemostatic forceps	63-73	Mamaplasty retractors	83-85
Haemostatic forceps	63-67	MARQUARDT bone rongeur	147
HAJEK mallet	115	MARTINEZ-KILNER nasal hooklet	79
HALLE elevator	124	MASING elevator	127
HALSEY needle holders	99	MATHIEU-OLSEN needle holders	98
HALSTED-MOSQUITO haemostatic forceps	68	MAYO scissors	17
HALSTED-MOSQUITO haemostatic forceps	64	MAYO-HEGAR needle holders	100
HARTMANN haemostatic forceps	68	MAYO-LEXER scissors	12
HARTMANN haemostatic forceps	64	MAYO-STILLE scissors	13
HARTMANN-HALLE nasal specula	132	MC DONALD periosteal raspatory	129
HEANEY needle holders	102	MC INDOE dressing forceps	46
HEGAR-BAUMGARTNER needle holders	98	MC INDOE scissors	26
HOLTZHEIMER self retaining retractors	87	MEAD mallets	115
HUMBY deEGatome	5	Measuring instruments	6
Instrument trays, stainless steel	159	METZENBAUM scissors	10
Iris scissors	24	METZENBAUM-FINO scissors	23
ITERSON trachea hooklets	80	METZENBAUM-FINO scissors	11
JACKSON trachea hooklets	81	METZENBAUM-NELSON scissors	21-22
JACOBSON micro-needle holders	108	MEYERDING retractors	87
JOSEPH elevator	124	MICRO-ADSON forceps	47-48
JOSEPH nasal hooklet	77	Micro-blade holder - micro-blades	1
JOSEPH nasal saws	135	Micro-forceps	56-58
JOSEPH scissors	30	MICRO-MOSQUITO haemostatic forceps	68
JOSEPH scissors	14	MICRO-MOSQUITO haemostatic forceps	64
KAHN scissors	34	Micro-needle holders	107-114
KAYE BLEPHAROPLASTY scissors	40	Micro-needle holders, round handle	109-111
KAYE RIBBON TYPE scissors	40	Micro-scissors	41-43
KAYE scissors	32	MIDDLETON-JANSEN septum forceps	140
KELLY haemostatic forceps	71	MILIGAN self retaining retractor	95
KELLY haemostatic forceps	65	MINI-FRIEDMAN bone rongeurs	145
KELLY scissors	19	MINI-RYDER needle holders	105
KELLY scissors	14	MODELL WIEN nasal specula	133
KELLY-RANKIN haemostatic forceps	71	MOSQUITO-DANDY haemostatic forceps	69
KELLY-RANKIN haemostatic forceps	65	Nasal and trachea hooklets	76-80
KILIAN chisel	117	Nasal rasps	136-138
KILIAN nasal specula	134	Nasal rasps with TC	138
KILIAN-CALUS chisel	117	Nasal saws	135
KILNER (RAGNELL) scissors	29	Nasal scissors	37
KILNER nasal hooklet	76, 79	Nasal specula	132-134
KILNER needle holder	102	Needle holders	97-114
KLEINERT-KURTZ tendon strippers	142	Needle holders, Micro-	107-114
KNAPP (ROLLET) trachea hooklet	82	Needle holders, Titanium-	113-114
KNAPP scissors	25	NEIVERT chisel	123
KNIGHT nasal scissors	37	NEIVERT needle holder	102
KOCHER haemostatic forceps	72	NEIVERT trachea hooklet	80
KOCHER haemostatic forceps	66	NEIVERT-ANDERSON chisels	123
KOCHER-FINO haemostatic forceps	67	NEUMANN scissors	26
Lacrimal dilators	149-150	OBWEGESER periosteal raspatories	
LANGE trachea hooklet	76	OBWEGESER retractors	
Leadhands	07	OEHLER dressing forceps	
LERICHE haemostatic forceps	71	OLSEN-HEGAR needle holders	
LEXER scissors	19	Osteotomes for maxilla	
LEXER scissors	12		
LICHTENBERG needle holders			

Index

Haemostatic forceps.....	70
PEAN haemostatic forceps.....	66
PÉAN-FINO haemostatic forceps.....	67
PECK-JOSEF scissors.....	20
Periosteal raspatories - elevators.....	128-129, 131
PIERSE micro-forceps.....	58
POTTS-SMITH dressing forceps.....	51
Probes.....	150
PROVIDENCE-HOSPITAL haemostatic forceps.....	69
QUINBY scissors.....	26
RAGNELL-DAVIS retractor.....	87
RAMPLEY sponge holding forceps.....	83
REES Bulldog scissors.....	35
REES scissors.....	35
Retractors.....	86-93
REYNOLDS (JAMESON) scissors.....	29
REYNOLDS scissors.....	13
RIBBON STEVENS scissors.....	27
RUBIN chisels.....	121
RUBIN septum forceps.....	140
RUSKIN bone rongeurs.....	147
RUSKIN-LISTON bone cutting forceps.....	158
RYDER needle holders.....	105
SAROT needle holders.....	102
Scalpel blades.....	3
Scalpel handle.....	2
SCHINK deEGatome.....	4
SCHWARZ nasal speculum.....	117
Scissors.....	10-44
Scissors for plastic surgery.....	29-34
Scissors, blepharoplasty.....	38-40
Scissors, dissecting.....	17-23
Scissors, face-lift.....	35-36
Scissors, fine.....	25-27
Scissors, Iris.....	24
Scissors, micro.....	41-44
Scissors, nasal.....	37
Scissors, tendon.....	28
Self retaining retractors.....	94-95
SEMKEN forceps.....	45
SENN-MUELLER retractors.....	86
Septum forceps.....	139-140
Septum-elevators.....	124-127
SHEA scissors.....	38
SHEEHAN nasal chisels.....	122
SILVER nasal chisels.....	122
Soft tissue retractors for maxillo facial surgery.....	92-93
STELLBRINK bone rongeurs.....	146
STEVENS scissors.....	28
STEVENS scissors.....	15
Strabismus scissors.....	25
STRANDELL-STILLE retractors.....	86
TAYLOR forceps.....	52
Tendon holding forceps.....	143-144
Tendon strippers.....	141-142
Tenotomy scissors.....	28
THOMS-ALLIS tissue holding forceps.....	74
THOREK scissors.....	37
TIECK-HALLE nasal speculum.....	132
TIERSCH deEGatome.....	

Tissue and intestinal holding forceps.....	74
Tissue and intestinal holding forceps.....	63
Trachea hooklets.....	81-82
TRAVERS self retaining retractor.....	95
TYP JUWELIER micro-forceps.....	57
ULTRA-MICRO-ADSON (BRAKA) forceps.....	48
VANNAS micro-scissors.....	43
VASCULAR needle holders.....	103
Vessel dilators.....	59
VOLKMANN retractors.....	86
WALTER chisels.....	121
WANGENSTEEN forceps.....	46
WATSON deEGatome.....	5
WATSON-CHEYNE periosteal raspatory.....	129
WAUGH forceps.....	50
WEBSTER needle holders.....	98
WEITLANER-LOKTITE self retaining retractors.....	94
WILDER lacrimal dilators.....	150
WILLIAMS lacrimal dilators.....	149
WILLIAMS tissue holding forceps.....	74
WULLSTEIN self retaining retractors.....	95
YANCOSKIE retractor.....	90
YASARGIL micro-needle holders.....	111
ZAUFAL-JANSEN bone rongeur.....	147

ALVIEXPO



CONTACT US



+92-52-4272140



alviexpo@gmail.com, alvi@skt.comsats.net.pk



Marala Road, Murad Pur, Sialkot-Pakistan