

ALVEXPO

Manufacturers & Exporters of Surgical Instruments

SURGICAL

INSTRUMENTS CATALOGUE



ALVEXPO

'Alvi Expo' is an internationally active company with its base at Sialkot (Pakistan).

Our foundations date back to the era when our forefathers crafted the instruments with their hands; a hammer, a chisel and a plier were the tools, a hearth and a wheeled blower were in their factory and coal and water were the chemicals. We pay tributes to them and feel proud to have laid brick over brick keeping pace with the changing world.

Through the year since its inception, 'Alvi Expo' is proud of having evolved a constant process of renovating Surgical & Dental Instruments.

With full range of manufacturing and production facilities with in its boundaries, supported by a fleet of experienced workmen, supervised by highly qualified management, who are proud worthy for their abilities of creating handicraft to meet new trends and international standards. 'Alvi Expo' is a 100 & export oriented unit. Our instruments are explicitly engineered to meet your Surgical & Dental requirements.

Made of high quality stainless steel, appropriately treated, the instruments are sufficiently tested to ensure that these are fault free and are guaranteed against defective material, corrosion, manufacturing lack and promised quality standards.

Objectives

Every team member is dedicated to endeavor to excel in professionalism making the best use of his abilities to the optimum betterment the outfit, so that our products, not only meet the traditional standards, but also are a specimen to follow, thereby ensuring customer's satisfaction as well as better product for the next generation.

Suggestions

we have a passion to excel and for that we welcome your suggestions for improvements of quality and extension in product range.



**DIAGNOSTIC SET
(ENT COMPLETE)
AE-001**

Consisting of Battery Handle (without Battery)
3 Ear Specula, 1 Nasel Specula,
2 Laryngeal Mirrors with Holder
1 Tongue Depressor Holder, 1 Bulb



**OTOSCOPE SET
AE-002**

Consisting of Battery Handle
(without Battery)
3 Ear Specula, 1 Nasel Specula,



**MAGILL
AE-003
17 cm, 6 3/4"**



**MAGILL
AE-004
20 cm, 8"**



**MAGILL
AE-005
25 cm, 10"**

LARYNGOSCOPE & ACCESSORIES



Laryngoskope und Zubehör
Laringoscopios y Accesorios

Laryngoscopes et accessories
Laringoscopi ed accessori



**GUEDEL-NEGUS
AE-006**
Battery handle only
with for Laryngoscope
blades No. 1 to 4
complete, in case.

**MCINTOSH
AE-011**
Fiber Optic Laryngoscope set
with 4 blades
(fig. 01 to 04) in wooden/ rexin box.

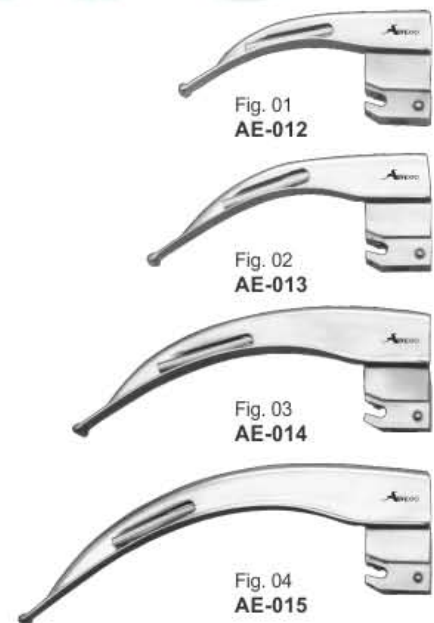

**BATTERY HANDLE
AE-016**
without battery
Use with battery - Size C
(AE-007 – AE-010
AE-012 – AE-015)

MC-INTOSH FIBER OPTIC LARYNGOSCOPE BLADE (English Pattern)

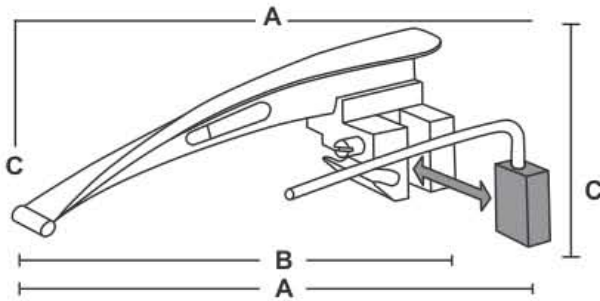

BLADE

Size	A	B	C	Working Length
0	77mm	53mm	14mm	55mm
1	95mm	72mm	43mm	70mm
2	111mm	86mm	44mm	78mm
3	133mm	109mm	44mm	108mm
4	151mm	129mm	44mm	133mm

Mc-Intosh Laryngoscope Fiber Optic

Halogen illumination. Manufactured from AISI 304 Stainless-Steel. Halogen Illumination 2.5 V. The Bulb is inside the handle in order to simplify the sterilization of the blades. All blades and handles are interchangeable with other leading manufacturer. All sets can be combined as per your request, and delivered in Green plastic case.

Blades Availability:

- * Matt Finish
- * Mirror Finish
- * Sand Blast Finish
- * Pls, confirm in your order list

Mc-INTOSH FIBER OPTIC LARYNGOSCOPE SET HALOGEN ILLUMINATION

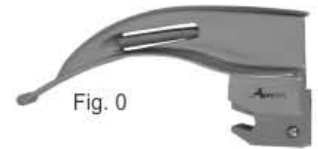

Fig. 0

AE-017 PEDIATRIC SET

Set of 0,1,2
Blades
Supplied in
Green plastic case



Fig. 1

AE-018 STANDARD SET

Set of 1,2,3
Blades
Supplied in
Green plastic case



Fig. 2

AE-019 ADULT SET

Set of 1,2,3,4
Blades
Supplied in
Green plastic case



Fig. 3



Fig. 4



Laryngoscope Battery
Handle for Adult
C type 2 batteries



Mc-Intosh Fiber Optic Laryngoscope Set
Halogen Illumination
Manufactured by AISI:
304 Stainless Steel Material

LARYNGOSCOPE & ACCESSORIES

Laryngoskope und Zubehör
Laringoscopios y Accesorios

Laryngoscopes et accessories
Laringoscopi ed accessori



MC-INTOSH LARYNGOSCOPE

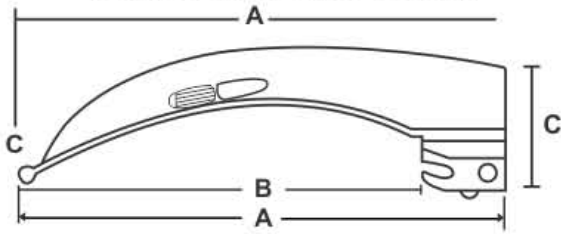

BLADE

Size	A	B	C	Working Length
0	80mm	58mm	30mm	55mm
1	97mm	76mm	36mm	70mm
2	111mm	88mm	36mm	78mm
3	133mm	112mm	36mm	108mm
4	154mm	131mm	38mm	133mm

Mc-Intosh Laryngoscope

Plastic case, Standard illumination. Manufactured from AISI 304 Stainless Steel Matt Type, Standard Illumination 2.5 V. All blades and handles are interchangeable with other leading manufacturer. All sets can be combined as per your request, and delivered in Gray plastic case.

Blades Availability:

- ★ Matt Finish
- ★ Mirror Finish
- ★ Sand Blast Finish
- ★ Pls, confirm in your order list

Conventional Laryngoscope Set

Mc-INTOSH LARYNGOSCOPE SET STANDARD ILLUMINATION

AVAILABLE SETS WITH BATTERY HANDLE

AE-020 PEDIATRIC SET
Set of 0,1,2
Blades
Supplied in Gray plastic case

AE-021 STANDARD SET
Set of 1,2,3
Blades
Supplied in Gray plastic case

AE-022 ADULT SET
Set of 1,2,3,4
Blades
Supplied in Gray plastic case

Fig. 0

Fig. 1

Fig. 2

Fig. 3

Fig. 4



Laryngoscope Battery Handle for Adult
C type 2 Batteries



With two Spare Bulbs



Mc-Intosh Laryngoscope Set
Standard Illumination
Manufactured From
Stainless Steel Material

LARYNGOSCOPE MILLER

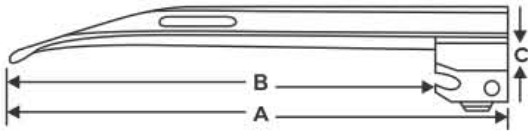

BLADE				
Size	A	B	C	Working Length
0	75mm	53mm	26mm	55mm
1	111mm	80mm	26mm	80mm
2	151mm	134mm	28mm	130mm
3	188mm	167mm	28mm	170mm
4	203mm	180mm	28mm	180mm

Mc-Intosh Laryngoscope

Plastic case, Standard illumination.
Manufactured from AISI 304 Stainless Steel.
All blades and handles are interchangeable
with other leading manufacturer. All sets
can be combined as per your request, and
delivered in Blue plastic case.

Blades Availability:

- ★ Matt Finish
- ★ Mirror Finish
- ★ Sand Blast Finish
- ★ Pls, confirm in your order list



Laryngoscope Battery
Handle for Adult C type
2 batteries



With two Spare
Bulbs

Conventional Laryngoscope Set

LARYNGOSCOPE SET OF CONVENTIONAL MILLER STANDARD ILLUMINATION

AVAILABLE SETS WITH BATTERY HANDLE

**AE-023
Pediatric Set**
Set of 3 Pcs
Blades 0,1,2
Supplied in
Blue plastic case



Fig. 1

**AE-024
Standard Set**
Set of 3 Pcs
Blades 1,2,3
Supplied in
Blue plastic case



Fig. 2

**AE-025
Adult Set**
Set of 4 Pcs
Blades 1,2,3,4
Supplied in
Blue plastic case



Fig. 3



Fig. 4



Laryngoscope Set of conventional Miller
Standard Illumination
Manufactured From Stainless Steel Material

DIAGNOSTIC SETS

Diagnostik-Bestestecke
Trousse à diagnostic

Juegos para diagnóstico
Astucci per diagnostica



Handle



Two laryngeal mirrors: n. 4 and 5



Bent-arm illuminator: pin contact fitting.



With 2 spare Bulbs



Specula

Professional Otoscope & Ophthalmology Set ENT Medical Diagnostic Set

AE-026

2.5 V Standard illumination for use with 2 batteries C type.

Including:

Otoscope Head: Luir Lock fitting.

Chrome plated.

Fix lens 4 x in plastic mount can be removed for introduction of instruments.

Specula sizes: 2.5, 3.5 & 4.5 mm Included,

Ophthalmoscope head: Luir Lock fitting.

Lens selection wheel permits choice of corrective lenses from 0 to - 20 and 0 to +20 diopters.

Single large circle aperture.

Bent-arm illuminator: pin contact fitting.

Nasal speculum: Chrome plated.

Two laryngeal mirrors: n. 4 and 5.

Battery handle: 28mm. For 2 cell C-batteries.

Chrome plated. For adjustment of all illumination.

Replacement bulb: 2.5 V

Diagnostic set is supplied in our new beautiful look and quality Blue Case, which protect our quality Products from moisturizing and damaging.



Otoscope Head



Nasal speculum: Chrome plated.



Ophthalmoscope head



ENT Specula

DIAGNOSTIC SETS

Diagnostik-Bestestecke
Trousse à diagnostic

Juegos para diagnóstico
Astucci per diagnostica



DIAGNOSTIC PENTOSCOPE SET AE-027

2.5 V Standard illumination for use with 2 batteries type AA.

Consisting:

Universal Handle thread type fit for all Pentoscope Heads like.

- Otoscope Head.
- Ophthalmoscope Head.
- Throat Branch Head.
- Mouth Mirrors Head.

It have two exploring mirrors No. 4 & 5 mm.

Its spare 06 disposable Plastic ear Canulas are with sizes 2 x 2.50 mm, 2 x 3.50 mm & 2 x 4.5 mm. On special order it can be as 2 x 1.5 mm for new born babies 2 x 2.5 mm for pediatric and 2 x 4 mm for adults, so it means total 06 canula also available in a plastic tube packing.

Sturdy adjustment mount bracket

2 spare 2.5 V bulb.

Pentoscope set battery handle is operating with two AA size batteries.

This Pentoscope set Packed in our new beautiful Blue Colour plastic case in same blue inner packing material. Spare parts also available of any item.



With 2 spare Bulbs



Mouth Mirrors Head



Standard illumination



Otoscope Head



Sturdy Adjustment Mount Bracket



Plastic ear Canulas

PERCUSSION HAMMERS



Perkussionshämmer
Martillos de percusion

Marteaux-percuteurs
Martelli percussori



NEURO-DUOFLEX
AE-028
22 cm, 8 3/4"



DEJERINE
AE-029
20 cm, 8"



DEJERINE
AE-030
20 cm, 8"



TROEMNER
AE-031 145 g
AE-032 175 g
AE-033 235 g
24.5 cm, 9 3/4"
spare rubber



TROEMNER-SIMPLEX
AE-034
21 cm, 8 1/4"



BUCK
AE-035
18.5 cm, 7 1/4"



BUCK HAMMER
AE-036
18 cm, 7"



TAYLOR
AE-037 18 cm, 7"
AE-038 20 cm, 8"



TAYLOR
AE-039
18 cm, 7"



BABINSKY
AE-040
22 cm, 8 3/4"



BABINSKY
AE-041
22 cm, 8 3/4"



RABINER
AE-042
25.5 cm, 10"
with needle & brush



BERLINER
AE-043
20 cm, 8"

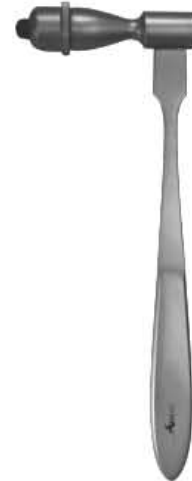

TRAUBE
AE-044
16 cm, 6 1/4"



WARTENBERG
AE-045
19 cm, 7 1/2"

Ø 1.5 mm



COUPLAND
AE-046

Ø 2.0 mm



BYRD
AE-047 1.5 mm
AE-048 2.5 mm
AE-049 3.5 mm

Ø 5 mm



DE-BAKEY
AE-050
16 cm, 5"
with finger cut-off
and stylet

Ø 4 mm



AE-051
19 cm, 7 1/4"
cut-off

Ø 5 mm



DE-BAKEY
AE-052
27 cm, 10 3/4"
with finger cut-off
and stylet

Ø 9 mm

Ø 9 mm



AE-053 Ø 4.5 mm
AE-054 Ø 5.5 mm
17.5 cm, 7"
Nasal suction tubes



LOPEZ-REINKE
AE-055
23.5 cm, 9"
tonsil dissector wiht
suction device.

Ø 6 mm



FERGUSON
AE-056 Ø 4.0 mm
18 cm, 7"
insulated, with finger
cut-off and stylet, thumb
piece 90° to curved, with
Luer hub

Ø 6-9 mm



FRAZIER
AE-057 Ø 3.0 mm
AE-058 Ø 5.0 mm
18 cm, 7"
insulated, with finger
cut-off and stylet, thumb
piece 90° to curved, with
Luer hub

Ø 6-9 mm



AE-059
18 cm, 7"
Ø 5.0 mm diam., Tip
6.5 mm wice nasal
section tube, with
luer hub

Ø 6-9 mm

DISSECTING KITS



Diagnostik-bestecke
Diagnostic Sets

Estuches de diagnostico
Combinazioni per diagnostica

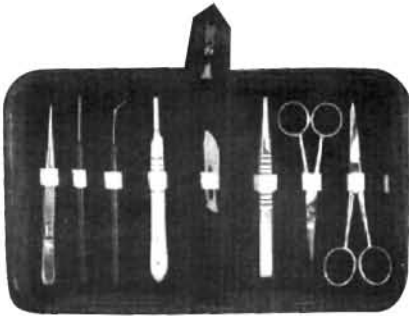

AE-060

Set of 9 Pcs.

- Dissecting Forceps 11.5cm Sharp Point.
- Teasing needle Sharp STR.
- Teasing Needle Sharp Angular.
- B.P Handle No.4.
- Blade No. 22.
- Thumb Forcep T.O.E 13cm.
- Dissecting Scissor STR 11.5cm.
- Dissecting Scissor STR 13cm.
- Zipper Case Inside Red Velvet.

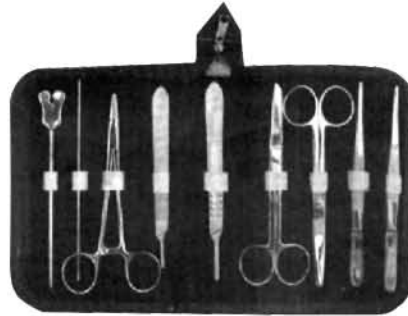

AE-061

Set of 10 Pcs.

- Grooved Director with Tongue Tie 14cm.
- Probe Double 14cm.
- Mayo Hegar Needle Holder 14cm.
- B.P Handle No.3
- B.P Handle No.4
- Dressing Scissor 14cm S/B STR.
- Dressing Scissor 14cm S/B CVD.
- Dressing Forcep 1x2 teeth 14cm.
- Dressing Forcep Serrated 14cm.
- Zipper Case Inside Red Velvet.



AE-062

Set of 10 Pcs.

- Probe Double 13cm.
- 2PCS. Scalpel S.S.
- Grooved Director With Tongue Tie 14cm
- Mayo Hegar Needle Holder 14cm.
- Dissecting Forceps 14cm 1x2 Teeth.
- Dressing Forceps 14cm Serrated.
- Dressing Scissor 14cm S/B STR.
- Dressing Scissor 14cm S/B CVD.
- Zipper Case Inside Red Velvet.



AE-063

Set of 10 Pcs.

- Blow Pipe.
- 3PCS Scalpel.
- Dissecting Forceps 14cm.
- Grooved Director With Tongue Tie 14cm
- Triple Chain Hook.
- Dressing Scissor Probe Pointed 14cm.
- Probe Double 14 cm.
- Zipper Case Inside Red Velvet.



DISSECTING SET

AE-064 Containing 9 Instruments

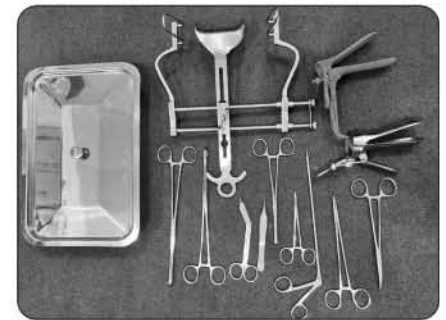

AE-065

C Section Set.



AE-066

Basic Laparotomy set



AE-067

D&C kit

SCALPEL HANDLES

Skalpелgriffe
Mangos de bisturíes

Manches pour bistouris
Manici per bisturi



#3 SCALPEL HANDLE
AE-068
12.75 cm, 5"
Blade Size
10, 11, 12, 15



**#3 SCALPEL HANDLE/
GRADUATED**
AE-069
12.75 cm, 5"
Blade Size
10, 11, 12, 15



#4 SCALPEL HANDLE
AE-070
12.75 cm, 5"
Blade Size
20, 22, 25



4L SCALPEL HANDLE
AE-071
21 cm, 8 1/4"



SCALPEL PLASTIC HANDLE
AE-072
8



COLLIN
AE-073
9



Fig. 10
Blade Sizes



Fig. 11



Fig. 12



Fig. 15



Fig. 20



Fig. 22



SCALPEL PLASTIC HANDLE
AE-074
5



SCALPEL PLASTIC HANDLE
AE-075
6



#3, #4 SCALPEL HANDLE
AE-076
16 cm, 6"



SCALPEL HANDLE 3L LONG
AE-077 21 cm, 8 1/4"
Blade Size 10, 11, 12, 15



#7 SCALPEL HANDLE
AE-078
16.5 cm, 6 1/4"
Blade 10, 11, 12, 15



SCALPEL HANDLE 4L long
AE-079
21 cm, 8 1/4"

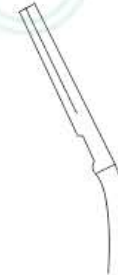

#3 SCALPEL HANDLE / LONG ANGLED
AE-080
20.25 cm, 8 1/4"
Blade Size 10, 11, 12, 15

DISSECTING KNIVES



Anatomische skalpelle
Bisturías para disección

Bistouris à dissection
Bisturi para dissezione

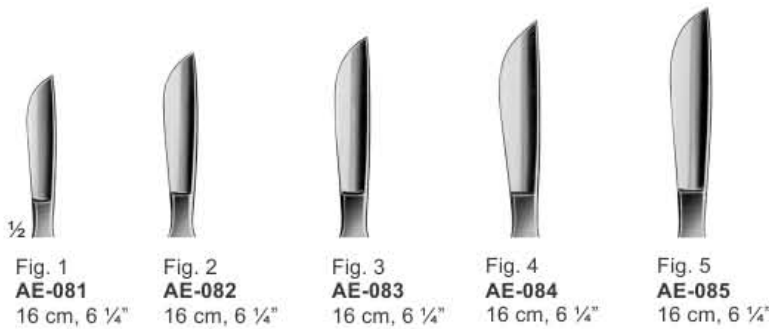

Fig. 1 **AE-081** 16 cm, 6 ¼"
Fig. 2 **AE-082** 16 cm, 6 ¼"
Fig. 3 **AE-083** 16 cm, 6 ¼"
Fig. 4 **AE-084** 16 cm, 6 ¼"
Fig. 5 **AE-085** 16 cm, 6 ¼"

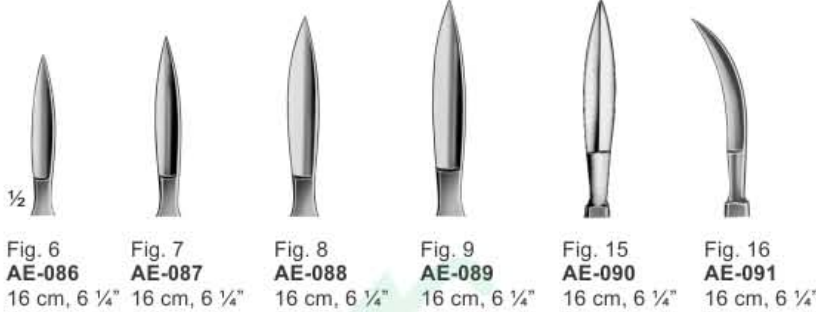

Fig. 6 **AE-086** 16 cm, 6 ¼"
Fig. 7 **AE-087** 16 cm, 6 ¼"
Fig. 8 **AE-088** 16 cm, 6 ¼"
Fig. 9 **AE-089** 16 cm, 6 ¼"
Fig. 15 **AE-090** 16 cm, 6 ¼"
Fig. 16 **AE-091** 16 cm, 6 ¼"



AE-092
17 cm, 6 ¾"



DIEFFENBACH
AE-093
16 cm, 6 ¼"



DISSECTING KNIFE
AE-094 15 cm, 6"
with metal handle

DIEFFENBACH
16 cm, 6 ¼"



Fig. 1 **AE-095** 14.5 cm, 5 ¾"
Fig. 2 **AE-096** 14.5 cm, 5 ¾"
Fig. 3 **AE-097** 14.5 cm, 5 ¾"

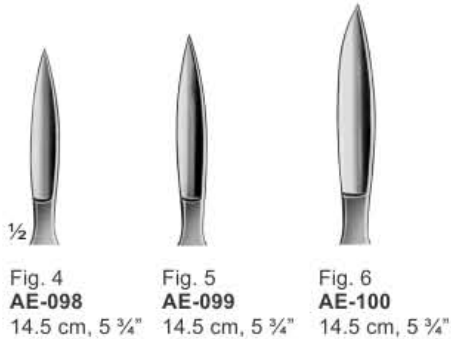

Fig. 4 **AE-098** 14.5 cm, 5 ¾"
Fig. 5 **AE-099** 14.5 cm, 5 ¾"
Fig. 6 **AE-100** 14.5 cm, 5 ¾"

COLLIN
14.5 cm, 5 ¾"



Fig. 1 **AE-101** 13.5 cm, 5 ¼"
Fig. 2 **AE-102** 13.5 cm, 5 ¼"
Fig. 3 **AE-103** 13.5 cm, 5 ¼"
Fig. 4 **AE-104** 13.5 cm, 5 ¼"
Fig. 5 **AE-105** 13.5 cm, 5 ¼"

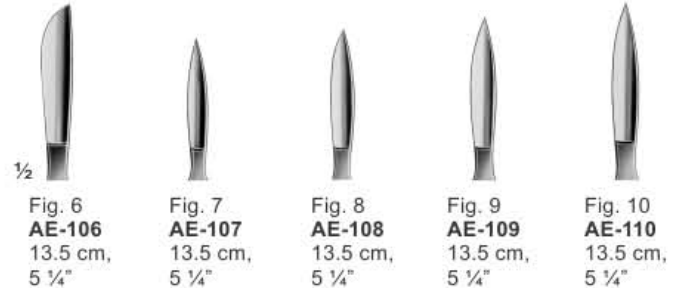

Fig. 6 **AE-106** 13.5 cm, 5 ¼"
Fig. 7 **AE-107** 13.5 cm, 5 ¼"
Fig. 8 **AE-108** 13.5 cm, 5 ¼"
Fig. 9 **AE-109** 13.5 cm, 5 ¼"
Fig. 10 **AE-110** 13.5 cm, 5 ¼"

DIEFFENBACH
13.5 cm

DISSECTING KNIVES

Anatomische skalpelle
Bisturías para disección

Bistouris à dissection
Bisturi para dissezione



**DISSECTING KNIFE
AE-111**
15 cm, 6"
with metal handle



Fig.1



Fig.2



Fig.3



Fig.4



Fig.5



Fig.6



Fig.7



Fig.8



Fig.9



Fig.10



**RAZOR
AE-112**
Hollow Blades On
Both Sides
AE-113
Blade Flat / Hollow



COLLIN Blade
AE-114 13 cm, 5"
AE-115 16 cm, 6 ¼"
AE-116 19 cm, 7 ½"
AE-117 22 cm, 8 ½"
AE-118 28 cm, 11 ¼"



CATLIN Blade
AE-119 16 cm, 6 ¼"
AE-120 19 cm, 7 ½"
AE-121 22 cm, 8 ½"



LISTON Blade
AE-122 16 cm, 6 ¼"
AE-123 19 cm, 7 ½"
AE-124 22 cm, 8 ½"



LANGENBECK Blade
AE-125
12 cm, 4 ¾"



**RESECTION
KNIFE**
AE-126
18 cm, 7"



**AMPUTATION
KNIFE**
AE-127
29 cm, 11 ½"

AMPUTATION, RESECTION & DISSECTING KNIVES



Amputationsmesser, Cuchillos para amputación, Anatomische skalpelle
 Couteaux à amputation, coltelli per amputazione, Bisturries para disección

Resektionsmesser, Cuchillos para resección, Bistouris à dissection
 Couteaux à résection, Coltelli per resezione, Bisturi para dissezione



COLLIN Blade
 AE-128 13 cm, 5"
 AE-129 16 cm, 6 ¼"
 AE-130 19 cm, 7 ½"
 AE-131 22 cm, 8 ½"
 AE-132 28 cm, 11 ¼"



CATLIN Blade
 AE-133 16 cm, 6 ¼"
 AE-134 19 cm, 7 ½"
 AE-135 22 cm, 8 ½"



LISTON Blade
 AE-136 16 cm, 6 ¼"
 AE-137 19 cm, 7 ½"
 AE-138 22 cm, 8 ½"



LANGENBECK Blade
 AE-139 12 cm, 4 ¾"



AMPUTATION KNIFE
 AE-140 29 cm, 11 ½"
 AE-141 32.5 cm, 13"



CATLIN
 AE-142 29 cm, 11 ½"



RESECTION KNIFE
 AE-143 18 cm, 7"



LANGENBECK
 AE-144 18 cm, 7"



LANGENBECK
 AE-145 18 cm, 7"



WALB
 AE-146 11 cm, 4 ½"
 AE-147 14 cm, 5 ½"
 AE-148 17 cm, 6 ¾"



VIRCHOW
 AE-149 16 cm, 6 ¼"
 AE-150 20 cm, 8"
 AE-151 24 cm, 9 ½"

ROUND PATTERN



STANDARD STRAIGHT

AE-152	11.5 cm, 4 ½"
AE-153	13.0 cm, 5"
AE-154	14.0 cm, 5 ½"
AE-155	15.0 cm, 6"
AE-156	16.0 cm, 6 ¼"
AE-157	17.5 cm, 7"
AE-158	18.5 cm, 7 ¼"
AE-159	20.0 cm, 8"
S/S Str.	



STANDARD CURVED

AE-160	11.5 cm, 4 ½"
AE-161	13.0 cm, 5"
AE-162	14.0 cm, 5 ½"
AE-163	15.0 cm, 6"
AE-164	16.0 cm, 6 ¼"
AE-165	17.5 cm, 7"
AE-166	18.5 cm, 7 ¼"
AE-167	20.0 cm, 8"
S/S Cvd.	

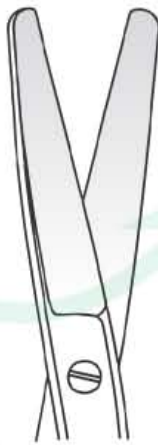

STANDARD STRAIGHT

AE-168	11.5 cm, 4 ½"
AE-169	13.0 cm, 5"
AE-170	14.0 cm, 5 ½"
AE-171	15.0 cm, 6"
AE-172	16.0 cm, 6 ¼"
AE-173	17.5 cm, 7"
AE-174	18.5 cm, 7 ¼"
AE-175	20.0 cm, 8"
B/B Str.	



STANDARD CURVED

AE-176	11.5 cm, 4 ½"
AE-177	13.0 cm, 5"
AE-178	14.0 cm, 5 ½"
AE-179	15.0 cm, 6"
AE-180	16.0 cm, 6 ¼"
AE-181	17.5 cm, 7"
AE-182	18.5 cm, 7 ¼"
AE-183	20.0 cm, 8"
B/B Cvd.	



STANDARD STRAIGHT

AE-184	11.5 cm, 4 ½"
AE-185	13.0 cm, 5"
AE-186	14.0 cm, 5 ½"
AE-187	15.0 cm, 6"
AE-188	16.0 cm, 6 ¼"
AE-189	17.5 cm, 7"
AE-190	18.5 cm, 7 ¼"
AE-191	20.0 cm, 8"



STANDARD CURVED

AE-192	11.5 cm, 4 ½"
AE-193	13.0 cm, 5"
AE-194	14.0 cm, 5 ½"
AE-195	15.0 cm, 6"
AE-196	16.0 cm, 6 ¼"
AE-197	17.5 cm, 7"
AE-198	18.5 cm, 7 ¼"
AE-199	20.0 cm, 8"

OPERATING, DISSECTING SCISSORS



Chirurgische scheren, Präparierscheren
Tijeras quirúrgicas, Tijeras de disección

Ciseaux chirurgicaux, Ciseaux à dissection
Forbici per chirurgia, Forbici per dissezione



DEAVER
AE-200
14.0 cm, 5 ½"

DEAVER
AE-201
14.0 cm, 5 ½"

MIXTER
AE-202
15.5 cm, 6"

MIXTER
AE-203
15.5 cm, 6"

JORGENSON
AE-204
22 cm, 8 ½"
Curved



INCISION SCISSORS
AE-205 13.0 cm, 5"
AE-206 14.5 cm, 5 ½"



INCISION SCISSORS
AE-207
15.5 cm, 6"



RICHTER
AE-208
14.5 cm, 5 ½"



FERGUSSON
AE-209 14.0 cm, 5 ½"
AE-210 16.5 cm, 6 ½"
AE-211 18.0 cm, 7"

OPERATING & DISSECTING SCISSORS

Chirurgische scheren, Präparierscheren
Tijeras quirúrgicas, Tijeras de disección

Ciseaux chirurgicaux, Ciseaux à dissection
Forbici per chirurgia, Forbici per dissezione

AE-215 14.5 cm, 5 1/2"
AE-216 15.0 cm, 6"
AE-217 17 cm, 6 3/4"

AE-220 15 cm, 6"
AE-221 17 cm, 6 3/4"
Cvd.

AE-223 17 cm, 6 3/4"
Cvd.

AE-224 14.5 cm, 5 3/4"
AE-225 18.0 cm, 7"
AE-226 20.0 cm, 8"
AE-227 23.0 cm, 9"
AE-228 25.0 cm, 10"
AE-229 28.0 cm, 11"
Str. & Cvd.

AE-230 14.5 cm, 5 3/4"
AE-231 18.0 cm, 7"
AE-232 20.0 cm, 8"
AE-233 23.0 cm, 9"
AE-234 25.0 cm, 10"
AE-235 28.0 cm, 11"
Str. & Cvd.

MAYO Str.
AE-212 14.5 cm, 5 1/2"
AE-213 15.0 cm, 6"
AE-214 17.0 cm, 6 3/4"

MAYO-STILLE
AE-218 15 cm, 6"
AE-219 17 cm, 6 3/4"
Str.

MAYO-NOBLE
AE-222 17 cm, 6 3/4"
Str.

METZENBAUM
Blunt / Blunt

METZENBAUM NELSON

Blade length
6.4 cm
5.1 cm
4.4 cm

AE-241 11.5 cm, 4 1/2"
Cvd.

METZENBAUM DISSECTING
AE-236 20.3 cm, 8"
AE-237 22.9 cm, 9"
AE-238 28.4 cm, 11"
Curved

METZENBAUM-JAMISON
AE-239 15.25 cm, 6"

METZENBAUM-BABY
AE-240 11.5 cm, 4 1/2"
Str.

THOREK
AE-242 19.0 cm, 7 1/2"

FACE-LIFT, DISSECTING, NASAL SCISSORS & OPERATING



Face-lift , Präparierscheren, Nasenscheren, Chirurgische scheren
face-Lift, Tijeras de disección, Tijeras nasales, Tijeras quirúrgicas

Face-lift, Ciseaux à dissection, Ciseaux nasaux, Ciseaux chirurgicaux
Face-lift, Forbici per dissezione, Forbici nasali, Forbici per chirurgia



LEXER-BABY
AE-244
10 cm, 4"

LEXER-BABY
AE-243
10 cm, 4"

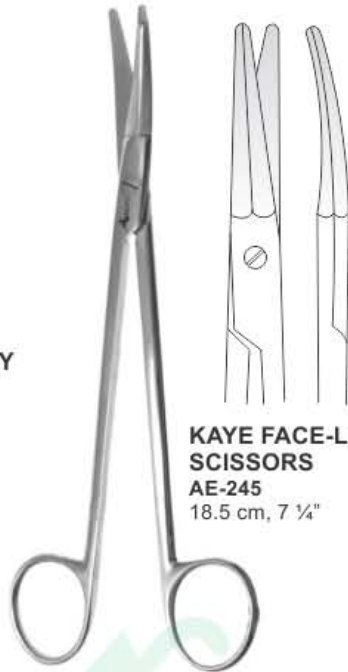

KAYE FACE-LIFT SCISSORS
AE-245
18.5 cm, 7 1/4"

KAYE FACE-LIFT SCISSORS



AE-246
13.5 cm, 5 1/4"

FOMON

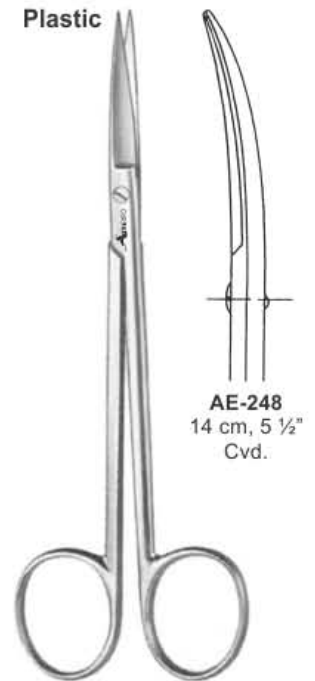

AE-248
14 cm, 5 1/2"
Cvd.

JOSEPH
AE-247
14 cm, 5 1/2"
Str.



Original
12.0 cm
AE-253 12.0 cm, 4 3/4"
AE-254 15.0 cm, 6"
AE-255 18.0 cm, 7"
AE-256 20.0 cm, 8"
Cvd.

KILNER
AE-249 12.0 cm, 4 3/4"
AE-250 15.0 cm, 6"
AE-251 18.0 cm, 7"
AE-252 20.0 cm, 8"
Str.

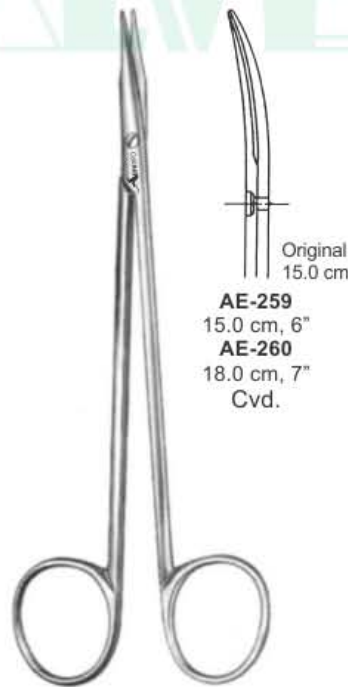

Original
15.0 cm
AE-259 15.0 cm, 6"
AE-260 18.0 cm, 7"
Cvd.

REYNOLDS
AE-257 15.0 cm, 6"
AE-258 18.0 cm, 7"
Str.

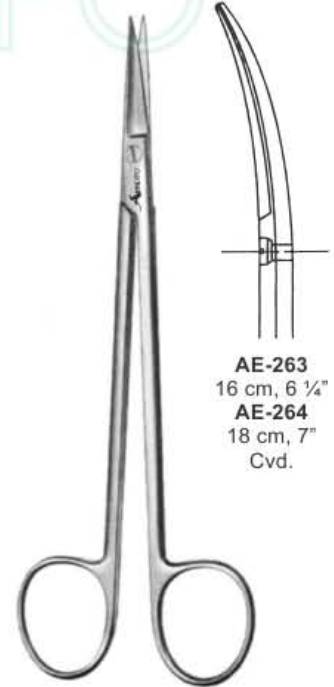

AE-263 16 cm, 6 1/4"
AE-264 18 cm, 7"
Cvd.

KELLY
AE-261 16.0 cm, 6 1/4"
AE-262 18.0 cm, 7"
Str.

GYNECOLOGICAL, IRIS & TENDON SCISSORS

Gynäkologische Scheren, Irisscheren, Schnenscheren
Tijeras para ginecología, Tijeras para Iridectomia, Tijeras para tendones

ciseaux à gynécologie, Ciseaux à iridectomie, Ciseaux à Ténotomie
Forbici per ginecologia, Forbici per iridectomia, Forbici per tenotomia



DOYEN
AE-265
16 cm, 6 1/4"
S/B, Str.



DOYEN
AE-266
16 cm, 6 1/4"
B/B, Str.



DOYEN
AE-268
17.5 cm, 6 3/4"
B/B, Str.

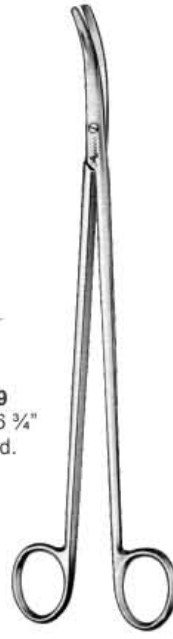

CARDINALE
AE-270
28 cm, 11"



SIMS
AE-271 20 cm, 8"
AE-272 23 cm, 9"
Straight, B/B



AE-273
20 cm, 8"
AE-274
23 cm, 9"
S/B



AE-275
20 cm, 8"
AE-276
23 cm, 9"
S/S



AE-277
20 cm, 8"
AE-278
23 cm, 9"
S/B



AE-279
20 cm, 8"
AE-280
23 cm, 9"
S/S



03-570 09 cm, 3 1/2"
03-571 10.5 cm, 4 1/4"
03-572 11.5 cm, 4 1/2"
03-573 12.0 cm, 4 3/4"
Str.

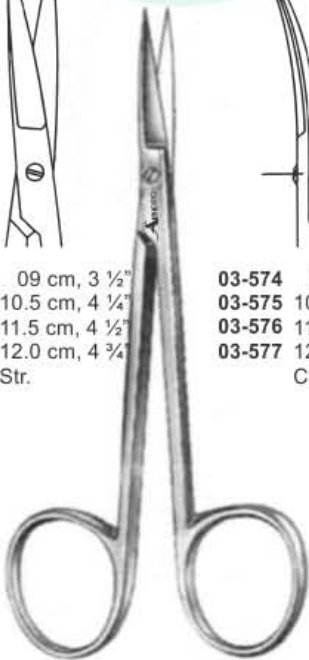

IRIS SCISSORS



03-574 09 cm, 3 1/2"
03-575 10.5 cm, 4 1/4"
03-576 11.5 cm, 4 1/2"
03-577 12.0 cm, 4 3/4"
Cvd.

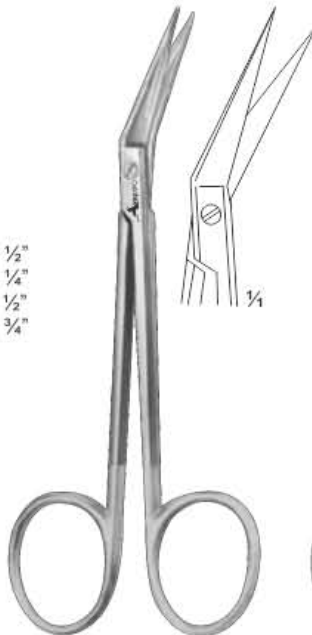

IRIS ANGULAR
03-590
11cm 4 1/4"



03-600
11.5 cm, 4 1/2"
Straight,
sharp/sharp

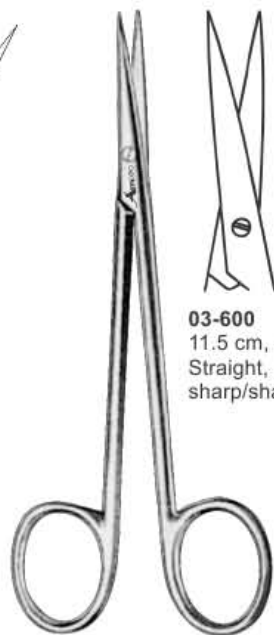

KILLNER

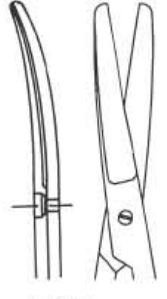

03-610
11.5 cm, 4 1/2"
Curved
03-611
11.5 cm, 4 1/2"
Straight

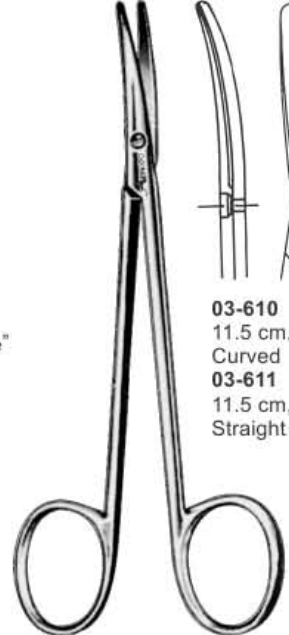

STRABISMUS

DISSECTING & VASCULAR SCISSORS



Präparierscheren, Gefäßscheren
Tijeras de disección, Tijeras vasculares

Ciseaux à dissection, Ciseaux vasculaires
Forbici per dissezione, Forbici vascolari



**POTTS-REYNOLDS
TENOTOMY**
AE-281
12 cm, 4 3/4"
Curved



POTTS TENOTOMY
AE-282 15.2 cm, 6"
AE-283 17.8 cm, 7"
AE-284 20.3 cm, 8"



SLAYER
AE-285
10 cm

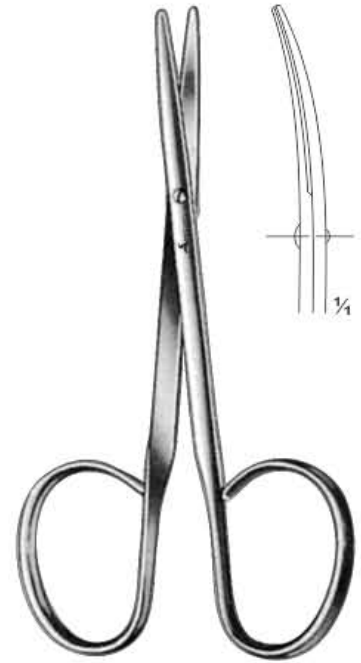

AE-286
10 cm, 4"
Straight

AE-287
10 cm, 4"
Curved

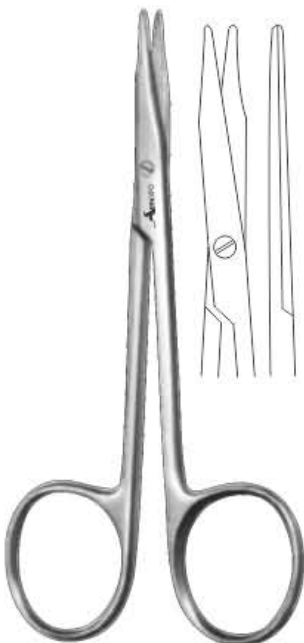

TENOTOMY-STEVENS
AE-288 Straight
AE-289 Curved
11 cm, 4 1/4"

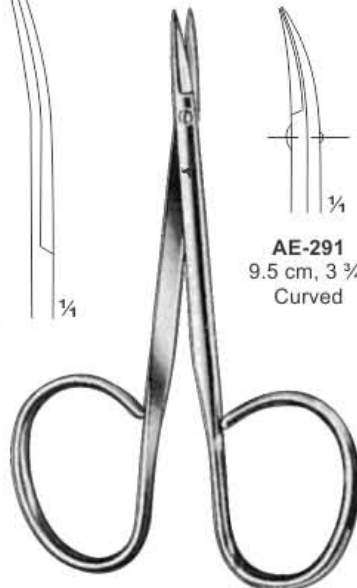
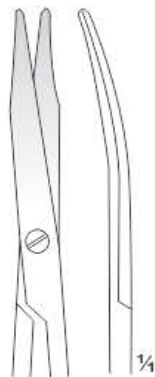

TENOTOMY
AE-290
9.5 cm, 3 3/4"
Straight



AE-291
9.5 cm, 3 3/4"
Curved

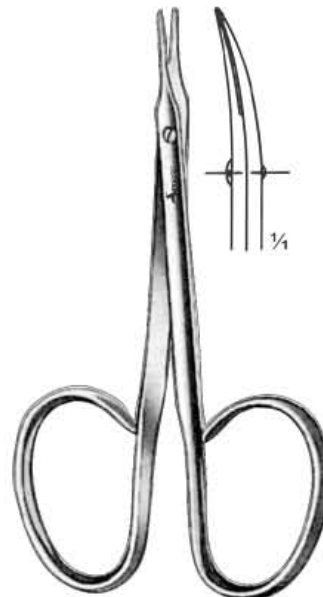

TENOTOMY
AE-292
9.5 cm, 3 3/4"
Curved-Ribbon
Handles blunt/blunt



**COOLEY REVERSE
Cut Scissors**
AE-293
angled 120°
17.1 cm, 6 3/4"

GUM, STITCH & WIRE CUTTING SCISSORS

Zahnfleischscheren, Fadenscheren, Drahtscheren

Ciseaux à gencives, Ciseaux à ligatures, Cisailles à fils

Tijeras para encias, Tijeras para hilos, Tijeras para alambres

Forbici per gengiva, Forbici per legature, Forbici per filo metallico



ROUND CUT
AE-294
23.5 cm, 9"



LE GRANGE
AE-295
11 cm, 4 1/4"



SCHOEMAKER-LOTH
AE-296
12.5 cm, 5"



SPENCER / DELICATE
AE-297
11 cm, 4 1/2"



LITTAUER
AE-298
14 cm, 5 1/2"



MODIFIED-USA
AE-299
10 cm, 4"

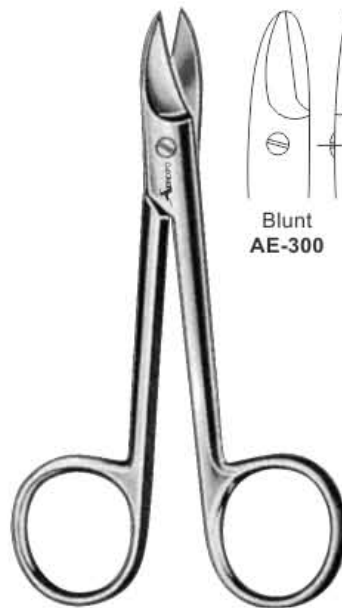

BEEBEE
10.5 cm, 4"
Straight

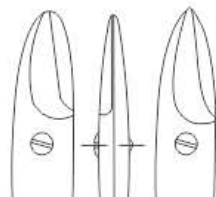

Blunt
AE-300 Pointed
AE-301

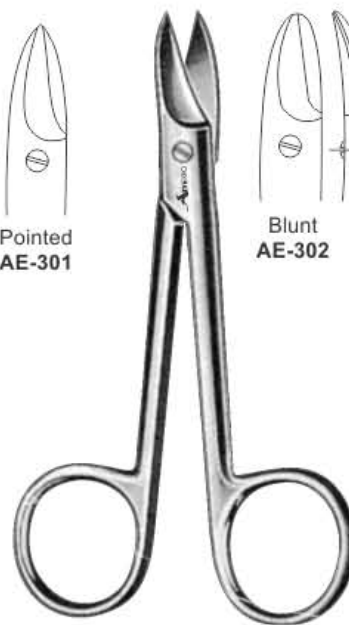

BEEBEE
10.5 cm, 4"
Curved

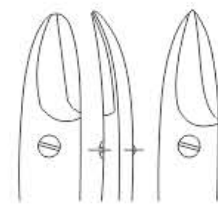

Blunt
AE-302 Pointed
AE-303

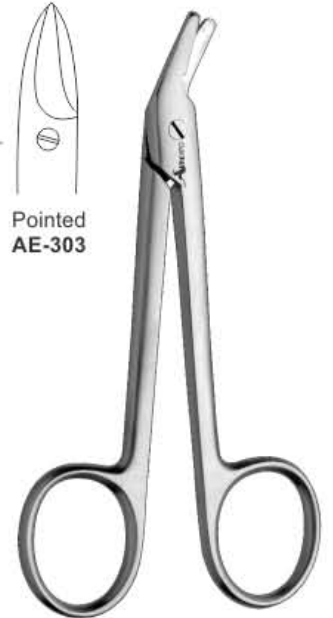

UNIVERSAL
AE-304
11.5 cm, 4 1/2"

SUPER CUT SCISSORS



scheren
Tijeras

Ciseaux
Forbici



STANDARD
AE-305
14 cm, 5 1/2"
Straight



STANDARD
AE-306
14 cm, 5 1/2"
Curved



MAYO
AE-307 14 cm, 5 1/2"
AE-308 15 cm, 6"
AE-309 18 cm, 7"
AE-310 20 cm, 8"
AE-311 23 cm, 9"



MAYO
AE-312
23 cm, 9"
Curved



MAYO
AE-313
23 cm, 9"
Straight



GOLDMAN-FOX
AE-314 Straight
AE-315 Curved
9.0 cm, 3 1/2"



STEVENS TENOTOMY
AE-316 Straight
AE-317 Curved
9.0 cm, 3 1/2"



IRIS
AE-318
9.0 cm, 3 1/2"
AE-319
11.4 cm, 4 1/2"
Straight



IRIS
Angular
AE-320
11.4 cm, 4 1/2"

PLASTER SCISSORS

Gipsschere
Tijera para yeso

Ciseaux pour plâtre
Forbici per gesso



UNIVERSAL (Colour Available)
AE-321 14.5 cm, 5 ¾"
 143 C/290 F Autoclavable
AE-322 15 cm, 6"
 143 C/290 F Autoclavable
AE-323 16 cm, 6 ¼"
 143 C/290 F Autoclavable
AE-324 18 cm, 7"
 143 C/290 F Autoclavable



UNIVERSAL BANDAGE
AE-325 12 cm, 5"

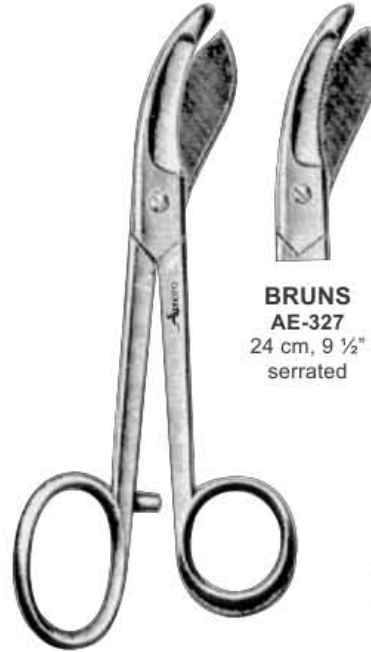

BRUNS
AE-327
 24 cm, 9 ½"
 serrated



LISTER
AE-328
 Excentric
 19 cm, 7 ½"



BERGMANN
AE-329
 23 cm, 9"



ESMARCH
AE-330
 20 cm, 8"
AE-331
 22 cm, 8 ¾"



BRAUN-STADLER
AE-332 14 cm, 5 ½"



BRAUN-STADLER
AE-333 20 cm, 8"



SMITH (MOD. USA)
AE-334 16 cm, 6 ¼"
AE-335 18 cm, 7"
AE-336 20 cm, 8"
AE-337 23 cm, 9"

PLASTER SCISSORS



Gipsschere
Tijera para yeso

Ciseaux pour plâtre
Forbici per gesso



for fingers

KNOWLES
AE-338
14 cm, 5 1/2"



LISTER
AE-339
21 cm, 8 1/4"



LISTER BANDAGE
AE-340 14 cm, 5 1/2"
AE-341 16 cm, 6 1/4"
AE-342 18 cm, 7"
AE-343 20 cm, 8"



LORENZ
AE-344
23 cm, 9"



KNOWLES
AE-345
14 cm, 5 1/2"



Saw Edge

LISTER-EXCENTRIC
AE-346 16 cm, 6 1/4"
AE-347 19 cm, 7 1/2"



KNOWLES
AE-348 14cm



ESMARCH
AE-349
20cm



SEUTIN
AE-350
23cm



WIRE & CLOTHING
AE-351 20cm

OPERATING SCISSORS T/C INSERTED

Chirurgische scheren
Tijeras quirúrgicas

Ciseaux chirurgicaux
Forbici per chirurgia



- AE-352 14.5 cm, 5 3/4" Straight
- AE-353 14.5 cm, 5 3/4" Curved
- AE-354 16.5 cm, 6 1/2" Straight
- AE-355 16.5 cm, 6 1/2" Curved
- AE-356 18.5 cm, 7 1/4" Straight
- AE-357 18.5 cm, 7 1/4" Curved

STANDARD



- AE-358 14.5 cm, 5 3/4" Straight
- AE-359 14.5 cm, 5 3/4" Curved
- AE-360 16.5 cm, 6 1/2" Straight
- AE-361 16.5 cm, 6 1/2" Curved
- AE-362 18.5 cm, 7 1/4" Straight
- AE-363 18.5 cm, 7 1/4" Curved

STANDARD

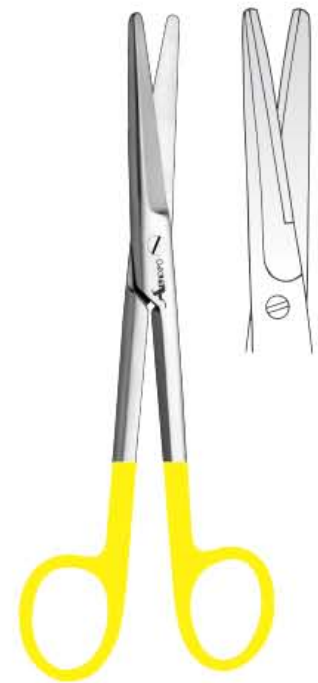

- MAYO**
- AE-364 14 cm, 5 1/2"
 - AE-365 17 cm, 6 3/4"
 - AE-366 23 cm, 9" blunt/blunt



- AE-367 14.5 cm, 5 3/4" Straight
- AE-368 14.5 cm, 5 3/4" Curved
- AE-369 16.5 cm, 6 1/2" Straight
- AE-370 16.5 cm, 6 1/2" Curved
- AE-371 18.5 cm, 7 1/4" Straight
- AE-372 18.5 cm, 7 1/4" Curved

STANDARD



- AE-375 15 cm, 6"
- AE-376 17 cm, 6 3/4" blunt/blunt, Cvd.

MAYO-STILLE

- AE-373 15 cm, 6"
- AE-374 17 cm, 6 3/4" blunt/blunt, Str.



- AE-379 16 cm, 6 1/4"
- AE-380 21.5 cm, 8 1/2" blunt/blunt, Cvd.

LEXER

- AE-377 16 cm, 6 1/4"
- AE-378 21.5 cm, 8 1/2" blunt/blunt, Str.

OPERATING & DISSECTING SCISSORS T/C INSERTED



Chirurgische scheren, Präparierscheren
Tijeras quirúrgicas, Tijeras de disección

Ciseaux chirurgicaux, Ciseaux à dissection
Forbici per chirurgia, Forbici per dissezione

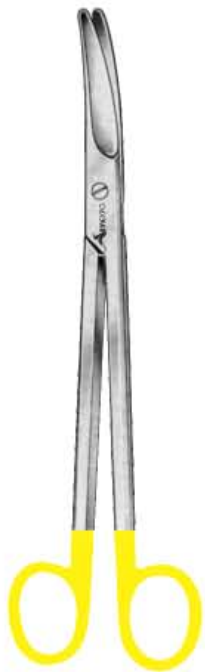

PARAMETRIUM
23 cm, 9"



AE-381
blunt/blunt
Str.



AE-382
blunt/blunt
Cvd.

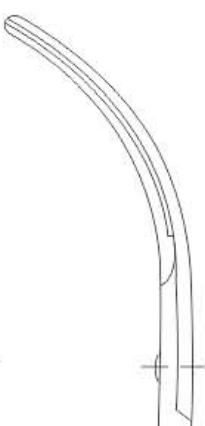

AE-383
blunt/blunt
Full Cvd.



GOLDMAN-FOX
AE-384
13 cm, 5"

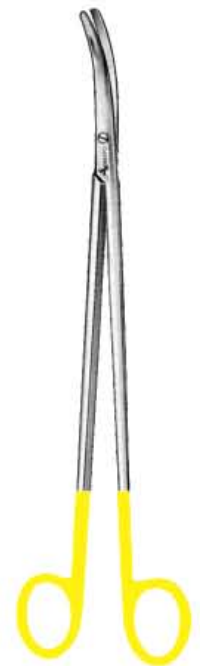

CARDINALE
AE-385
28 cm, 11"

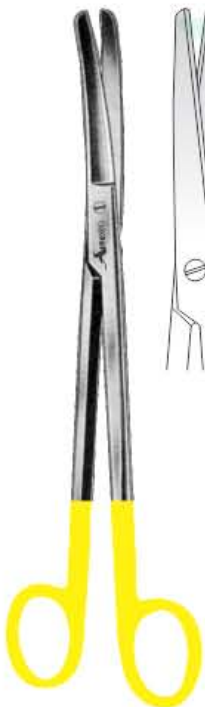

SIMS
AE-386
23 cm, 9"
Curved

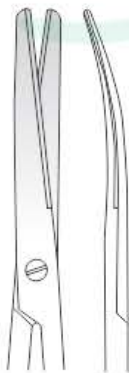

AE-387 14.5 cm, 5 3/4"
AE-388 18.0 cm, 7"
AE-389 20.0 cm, 8"
AE-390 23.0 cm, 9"
AE-391 25.0 cm, 10"
AE-392 28.0 cm, 11"
Blunt / Blunt Curved

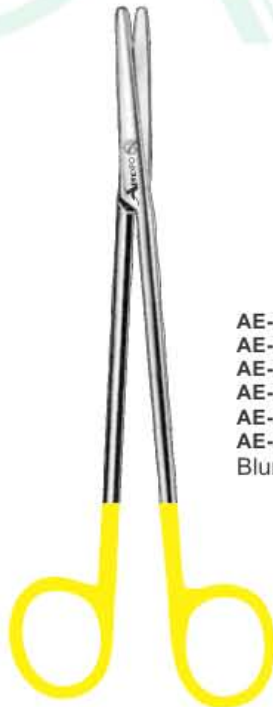

**METZENBAUM
DELICATE**

AE-393 14.5 cm, 5 3/4"
AE-394 18.0 cm, 7"
AE-395 20.0 cm, 8"
AE-396 23.0 cm, 9"
AE-397 25.0 cm, 10"
AE-398 28.0 cm, 11"
Blunt / Blunt Straight



AE-399 14.5 cm, 5 3/4"
AE-400 18.0 cm, 7"
AE-401 20.0 cm, 8"
AE-402 23.0 cm, 9"
AE-403 25.0 cm, 10"
AE-404 28.0 cm, 11"
Sharp / Sharp Curved

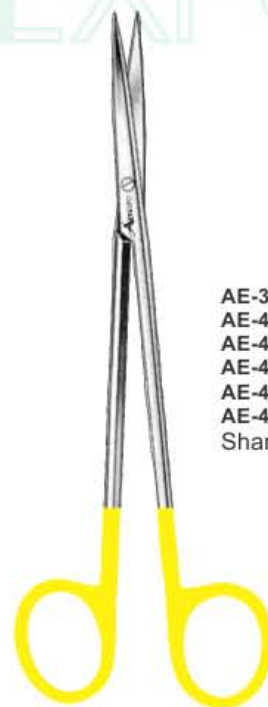

**METZENBAUM
DELICATE**



AE-405 14.5 cm, 5 3/4"
AE-406 18.0 cm, 7"
AE-407 20.0 cm, 8"
AE-408 23.0 cm, 9"
AE-409 25.0 cm, 10"
AE-410 28.0 cm, 11"
Sharp / Sharp Straight



DRESSING & TISSUE FORCEPS



Anatomische pinzetten, Pincas a tissu
Pinzas de disección, Gewebe

Pincas à dissection, Pinzas para tejidos
Pinze per dissezione, Pinze per tessuti



- AE-430 10.5 cm, 4"
- AE-431 11.5 cm, 4 1/2"
- AE-432 12.5 cm, 5"
- AE-433 14.0 cm, 5 1/2"
- AE-434 16.0 cm 6 1/4"
- AE-435 18.0 cm, 7"
- AE-436 20.0 cm, 8"
- AE-437 25.0 cm, 10"
- AE-438 30.0 cm, 12"

STANDARD



- AE-439 10.5 cm, 4"
- AE-440 11.5 cm 4 1/2"
- AE-441 12.5 cm 5"
- AE-442 14.0 cm, 5 1/2"
- AE-443 16.0 cm 6 1/4"
- AE-444 18.0 cm, 7"
- AE-445 20.0 cm, 8"
- AE-446 25.0 cm. 10"
- AE-447 30.0 cm, 12"

STANDARD 1:2



- SEMKEN**
AE-448 12.5 cm, 5"
AE-449 15.5 cm, 6"

SEMKEN



- SEMKEN 1:2**
AE-450 12.5 cm, 5"
AE-451 15.0 cm, 6"

SEMKEN 1:2



- BROPHY**
AE-454 20 cm, 8"

BROPHY



- BROPHY 1 : 2**
AE-456 20 cm, 8"

BROPHY 1 : 2

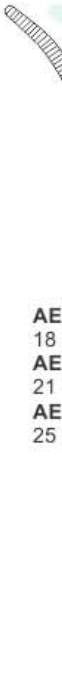

- AE-461 18 cm, 7"
- AE-462 21 cm, 8.5"
- AE-463 25 cm, 10"

- POTTS-SMITH**
AE-458 18 cm, 7"
AE-459 21 cm, 8.5"
AE-460 25 cm, 10"

POTTS-SMITH



- AE-467 18 cm, 7"
- AE-468 21 cm, 8"
- AE-469 25 cm, 10"

- POTTS-SMITH 1 : 2**
AE-464 18 cm, 7"
AE-465 21 cm, 8"
AE-466 25 cm, 10"

POTTS-SMITH 1 : 2



- GERALD**
AE-470 18 cm, 7"

GERALD



- GERALD 1 : 2**
AE-471 17 cm, 6.75"

GERALD 1 : 2



- CUSHING**
AE-473 17.5 cm, 7"

CUSHING



- CUSHING 1:2**
AE-474 17.5 cm, 7"

CUSHING 1:2



- WANGENSTEEN**
AE-476 23 cm, 9"

WANGENSTEEN

TISSUE & DRESSING FORCEPS

Pincas a tissu, Anatomische pinzetten
Gewebe, Pinzas de disección

Pinzas para tejidos, Pincas à dissection
Pinze per tessuti, Pinze per dissezione



TAYLOR 1:2
AE-477
17.5 cm, 7"



GILLIES 1:2
AE-479
15 cm, 6"



AE-480 11.5 cm 4 1/2"
AE-481 13.0 cm 5"
AE-482 14.5 cm 5 1/2"
AE-483 16.0 cm 6 1/4"
AE-484 18.0 cm 7"
AE-485 20.0 cm 8"
AE-486 25.0 cm 10"
AE-487 30.0 cm 12"



AE-488 13 cm, 5"
AE-489 14.5 cm, 5 1/2"
AE-490 16 cm, 6 1/4"



AE-491 13 cm, 5"
AE-492 14.5 cm, 5 1/2"
AE-493 16 cm, 6 1/4"



STILLE 1:2
AE-494
15 cm, 6"



STILLE 2:3
AE-495
15 cm, 6"



MCINDOE
AE-496 15.0 cm, 6"
Dissecting Forceps
non-toothed,
serrated jaws.



JEAN 1:2
AE-497 14 cm, 5 1/2"
AE-498 18 cm, 7"
Dissecting Forceps
one into two teeth on
serrated jaws.



TREVES 1:2
AE-499 12.5 cm, 5"
AE-500 15.0 cm, 6"
AE-501 18.0 cm, 7"
Dissecting Forceps
teeth, on smooth jaws.



RAMSAY 1:2
AE-502 18.0 cm, 7"
Dissecting Forceps
one into teeth on
serrated jaws.
As above but into
three teeth.



AE-503 12.5 cm, 5"
AE-504 15.0 cm, 6"
AE-505 18.0 cm, 7"
Dissecting Forceps
turn over end,
serrated jaws.



FERRIS-SMITH 1:2
AE-506
18 cm, 7"

TISSUE & DRESSING FORCEPS



Pinces a tissu, Anatomische pinzetten
Gewebe, Pinzas de disección

Pinzas para tejidos, Pincas à dissection
Pinze per tessuti, Pinze per dissezione

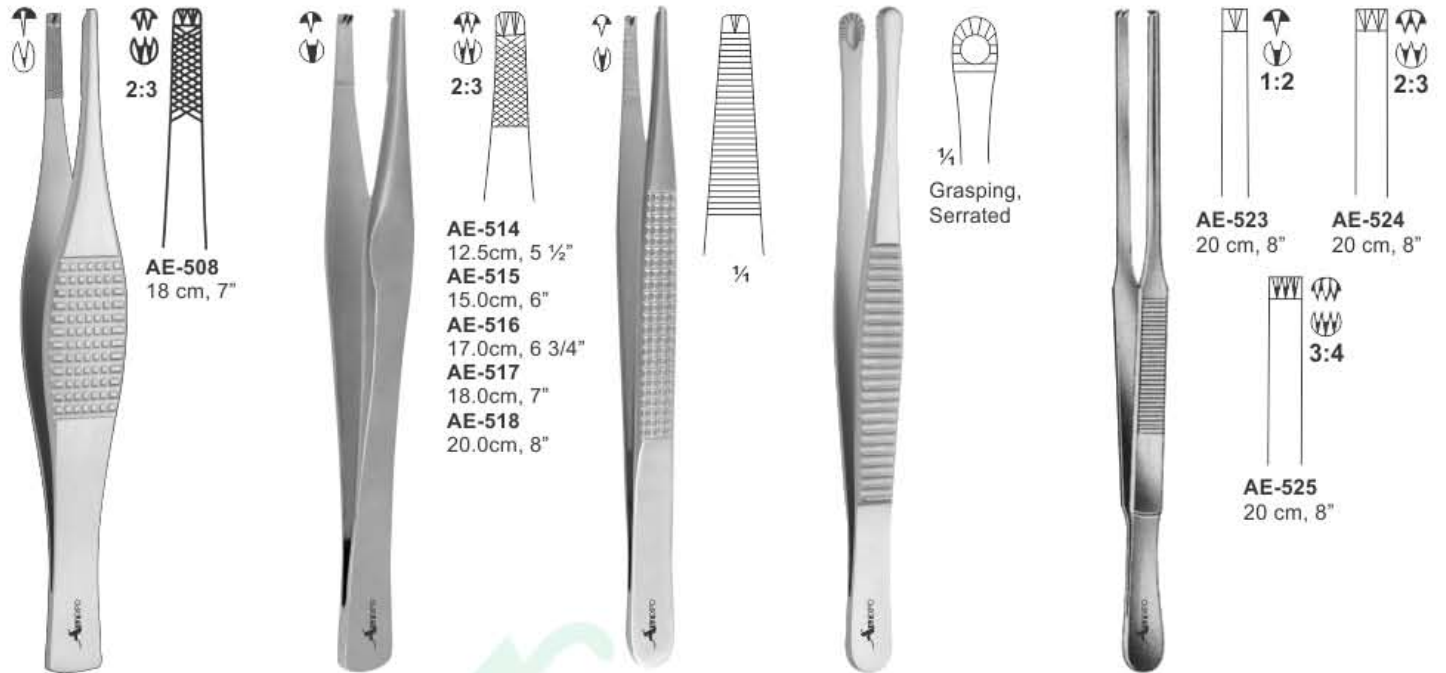

FERRIS-SMITH 1:2
AE-507
18 cm, 7"

LANE 1:2
AE-509 12.5cm, 5 1/2"
AE-510 15 cm, 6"
AE-511 17 cm, 6 3/4"
AE-512 18 cm, 7"
AE-513 20 cm, 8"

BONNEY 1:2
AE-519
18 cm, 7"

RUSSIAN-MODELL
AE-520 15 cm, 5 3/4"
AE-521 20 cm, 8"
AE-522 25 cm, 10"

DUEHRSSSEN

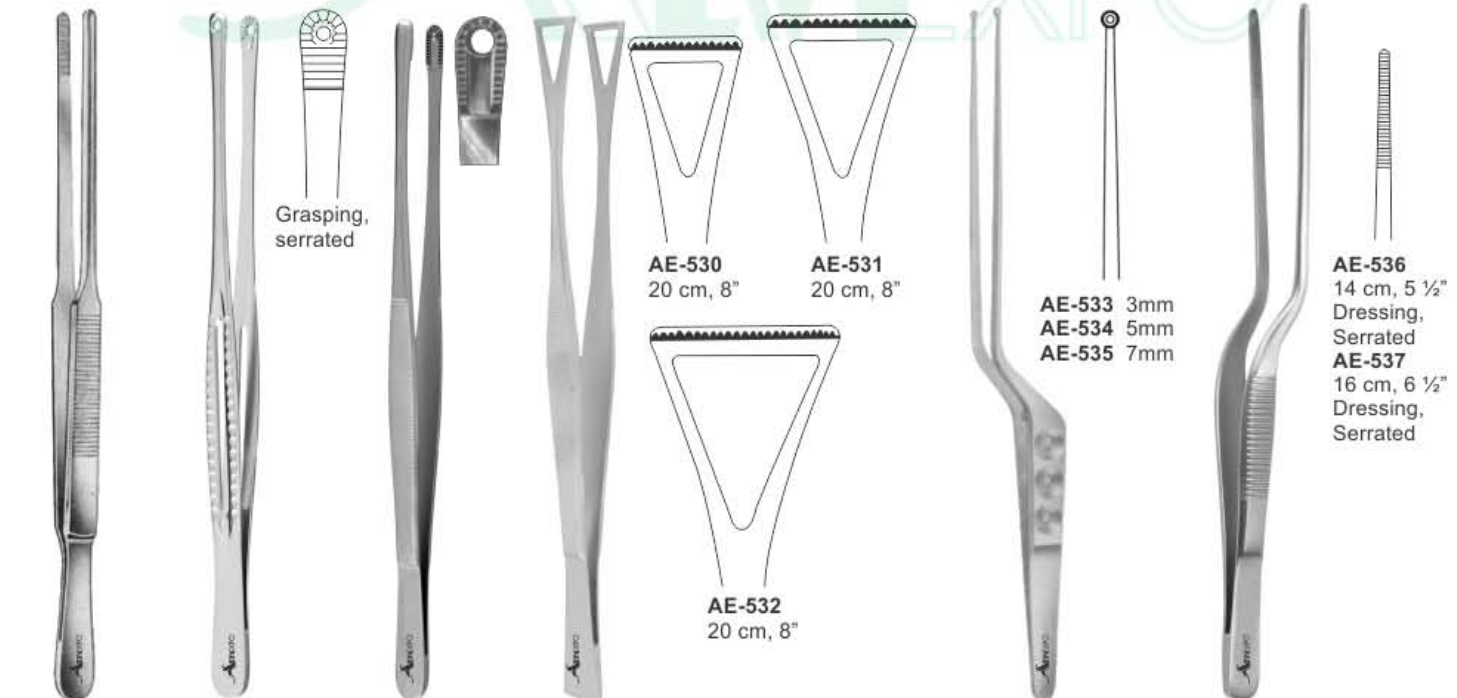

DUEHRSSSEN
AE-526
20 cm, 8"

MAYO-RUSSIAN
AE-527
15.5cm, 6"
AE-528
23.0cm, 9"

DAVIS
AE-529
25 cm, 10"

COLLIN-DUVAL

YASARGIL-SAMI
Jaws Spoon-Shaped
24 cm, 9 1/4"

LUCAE / ENT



Micro-Adson
AE-538 12 cm
AE-539 13 cm
AE-540 15 cm



Adson
 1x2 teeth
AE-541 12 cm
AE-542 15 cm
AE-543 18 cm
AE-544 20 cm



Micro-Adson
 1x2 teeth
AE-545 12 cm
AE-546 15 cm
AE-547 18 cm
AE-548 20 cm



Adson
 2x3 teeth
AE-549 12 cm
AE-550 15 cm
AE-551 18 cm
AE-552 20 cm



Adson-Brown
AE-553 12 cm
 Straight



Adson-Brown
AE-554 12 cm
 Curved



Adson-Graefe
AE-555
 12 cm



Hudson
AE-556 12 cm
AE-557 15 cm
 1x2 teeth



Thorpe
 Corneal Forceps
AE-558 12 cm



Adson Tissue Forceps
 Cuter Print



AE-559 regular point straight
AE-560 fine point straight
AE-561 micro point straight
 12 cm 1x2 Teeth



AE-562 regular point with platform straight
AE-563 fine point with platform straight
AE-564 micro point with platform straight
 12 cm 1x2 Teeth



AE-565 regular point curved
AE-566 fine point curved
AE-567 micro point curved
 12 cm 1x2 Teeth



AE-568 regular point straight
AE-569 fine point straight
AE-570 micro point straight
 12 cm 1x2 Teeth

JEWELER TYPE & SPLINTER FORCEPS



Splitterpinzetten
Pinzas Para espinas

Pinces à échardes
Pinze per scheggie



Jewelers Forceps Jewelers Forceps Jewelers Forceps Jewelers Forceps Jewelers Forceps Jewelers Forceps Jewelers Forceps Jewelers Forceps
 AE-571 AE-572 AE-573 AE-574 AE-575 AE-576 AE-577 AE-578

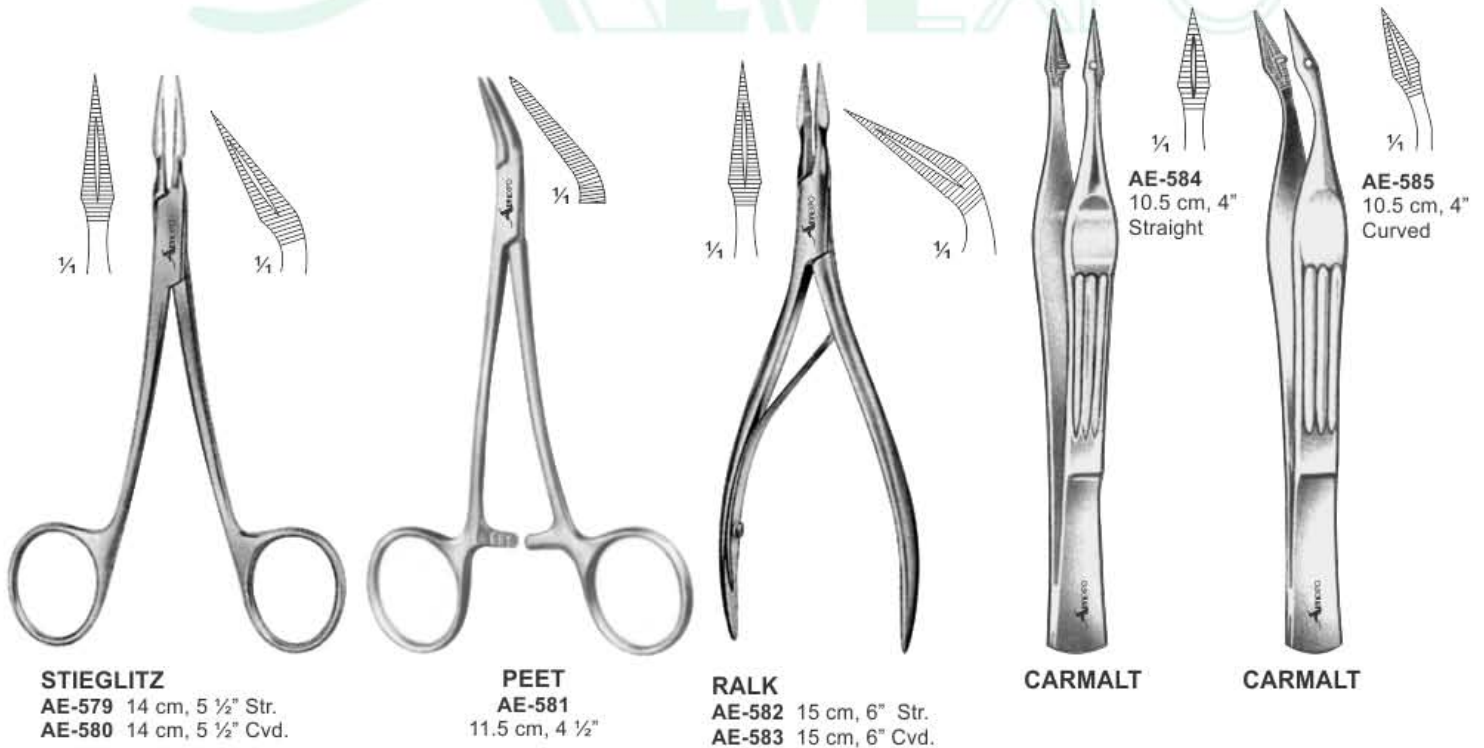

STIEGLITZ
 AE-579 14 cm, 5 1/2" Str.
 AE-580 14 cm, 5 1/2" Cvd.

PEET
 AE-581
 11.5 cm, 4 1/2"

RALK
 AE-582 15 cm, 6" Str.
 AE-583 15 cm, 6" Cvd.

CARMALT

CARMALT

1/4
AE-584
 10.5 cm, 4"
 Straight

1/4
AE-585
 10.5 cm, 4"
 Curved

TISSUE & DRESSING FORCEPS T.C

Pincas a tissu, Anatomische pinzetten
Gewebe, Pinzas de disección

Pinzas para tejidos, Pincas à dissection
Pinze per tessuti, Pinze per dissezione



- AE-586 13 cm, 5 1/4"
- AE-587 14 cm, 5 1/2"
- AE-588 16 cm, 6 1/4"
- AE-589 18 cm, 7"
- AE-590 20 cm, 8"
- AE-591 25 cm, 10"

STANDARD



- AE-592 14 cm, 5 1/2"
- AE-593 16 cm, 6 1/4"
- AE-594 18 cm, 7"
- AE-595 20 cm, 8"
- AE-596 25 cm, 20"
- AE-597 30 cm, 12"

STANDARD



- AE-598 12 cm, 5" cross serration
- AE-599 12 cm, 5" cross serration-1:2 Teeth
- AE-600 15.0 cm, 6" cross serration-1:2 Teeth



- AE-601 12 cm, 5" Dressing, cross serration
- AE-602 12 cm, 5" Tissue, cross serration-1:2 Teeth

ADSON

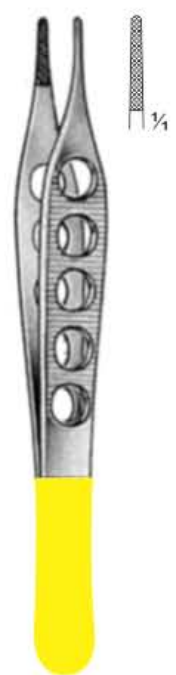

ADSON
AE-603 12 cm, 5"



- AE-604 15.2 cm, 6"
- AE-605 22.9 cm, 9"
- AE-606 25.4 cm, 10"

WANGENSTEEN
TISSUE FORCEPS



WANGENSTEEN
AE-607 15 cm, 6"
AE-608 23 cm, 9"
AE-609 25 cm, 10"



BONNEY
DISSECTING



- AE-610 18 cm Straight X-Serrations 1:2 Teeth



- AE-611 18 cm Straight, Serrated-1:2 Teeth



- AE-612 18 cm Straight, Serrated-2:3 Teeth



POTTS-SMITH
FORCEPS
AE-613 15 cm, 6"
AE-614 18 cm, 7"
AE-615 20 cm, 8"
AE-616 23 cm, 9"
AE-617 25 cm, 10"

HAEMOSTATIC FORCEPS



Arterienklemmen
Pinzas hemostaticas

Pinces hemostatiques
Pinze emostatiche



CARREL
AE-618
8.5 cm, 3 1/4"

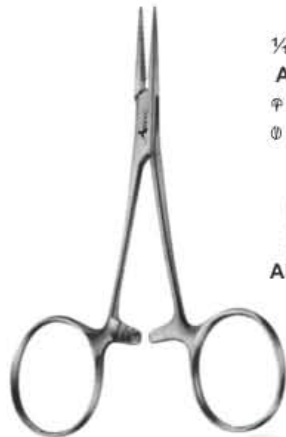

**BABY-MOSQUITO
(HARTMANN)**
10 cm, 4"



MICRO-HALSTED
12.5 cm, 5"

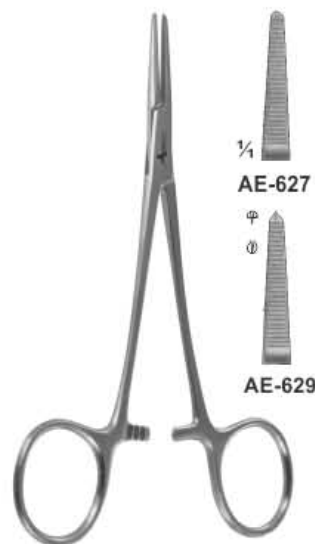

HALSTED-MOSQUITO
12.5 cm, 5"

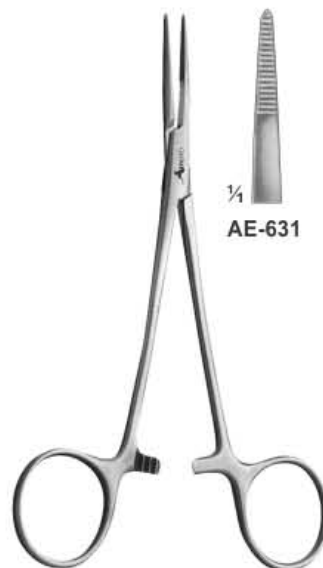
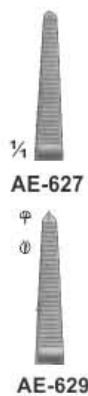

PROVIDENCE-HOSPITAL
14.0 cm, 5 1/2"



KELLY
14.0 cm, 5 1/2"



HAEMOSTATIC FORCEPS

Arterienklemmen
Pinzas hemostaticas

Pinces hemostatiques
Pinze emostatiche

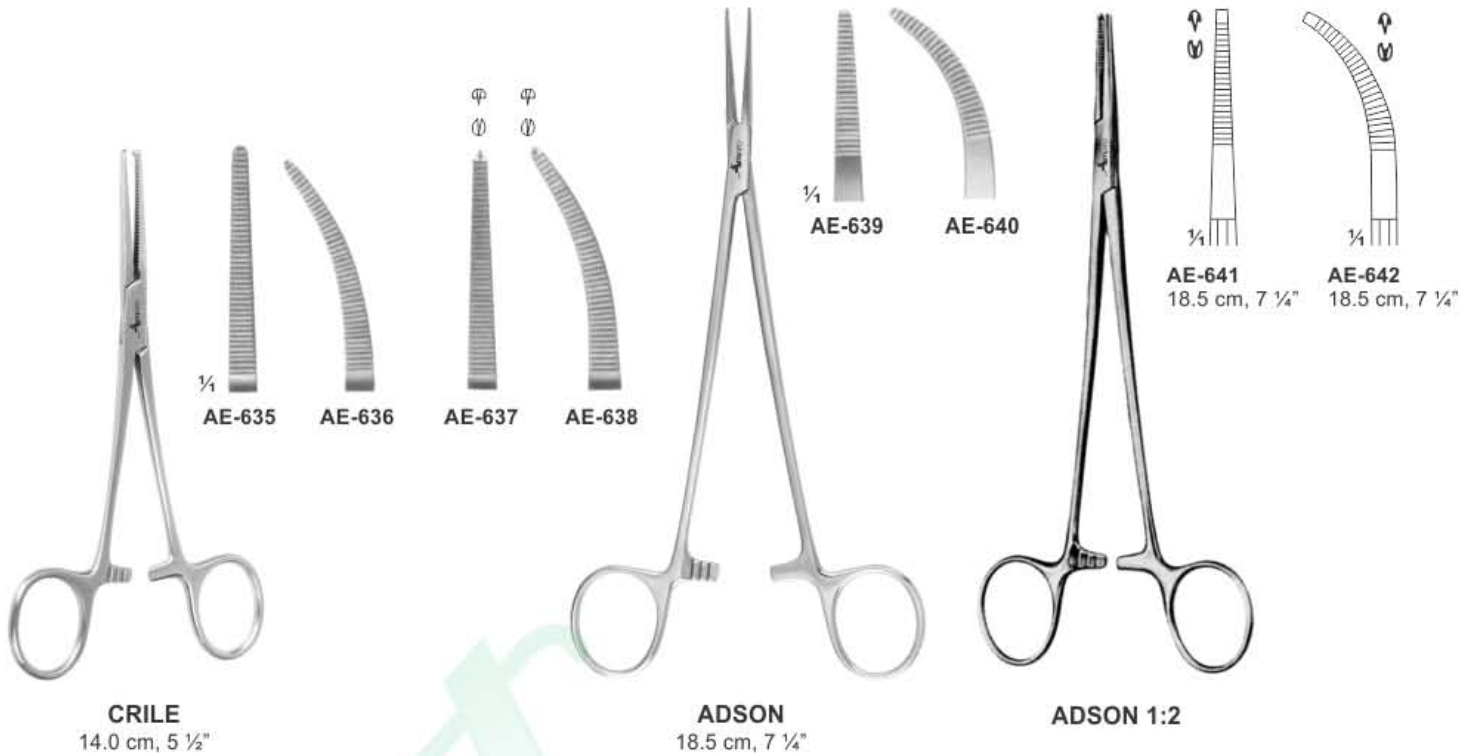

HAEMOSTATIC FORCEPS



Arterienklemmen
Pinzas hemostaticas

Pinces hemostatiques
Pinze emostatiche



CAIRNS
AE-651
14.5 cm, 5 3/4"
Straight, box joint, as above but curved on flat.



CAIRNS
AE-652
14.5 cm, 5 3/4"
curved laterally, joint



AE-653	13.0 cm	AE-657	13.0 cm
AE-654	15.0 cm	AE-658	15.0 cm
AE-655	17.5 cm	AE-659	17.5 cm
AE-656	20 cm	AE-660	20 cm

SPENCER-WELLS
Slender Type



PEAN

AE-661	24cm, 9 3/4"	AE-664	24cm, 9 3/4"
AE-662	26cm, 10 1/4"	AE-665	26cm, 10 1/4"
AE-663	28cm, 11"	AE-666	28cm, 11"

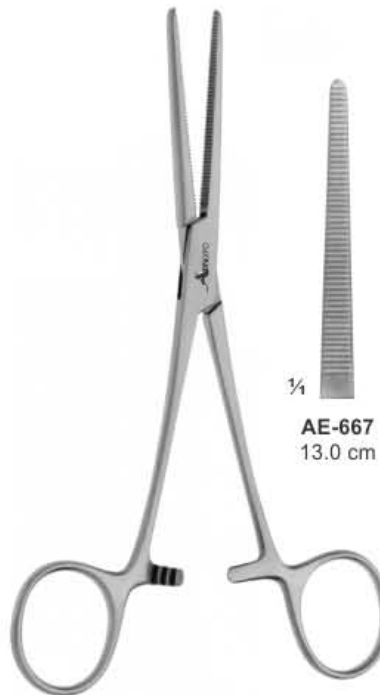
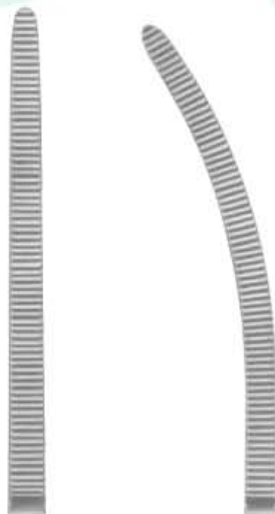

PEAN
Slender Type

AE-667	13.0 cm	AE-668	14.0 cm	AE-669	13.0 cm	AE-670	14.0 cm
---------------	---------	---------------	---------	---------------	---------	---------------	---------

HAEMOSTATIC FORCEPS

Arterienklemmen
Pinzas hemostaticas

Pinces hemostatiques
Pinze emostatiche



ROCHESTER-PEAN

- AE-671 16cm, 6 ¼"
- AE-672 18.5cm, 7 ¼"
- AE-673 20cm, 8"
- AE-674 22.5cm, 9"
- AE-675 24.0cm, 9 ¾"
- AE-676 26cm, 10 ¼"



- AE-677 16cm, 6 ¼"
- AE-678 18.5cm, 7 ¼"
- AE-679 20cm, 8"
- AE-680 22.5cm, 9"
- AE-681 24.0cm, 9 ¾"
- AE-682 26cm, 10 ¼"

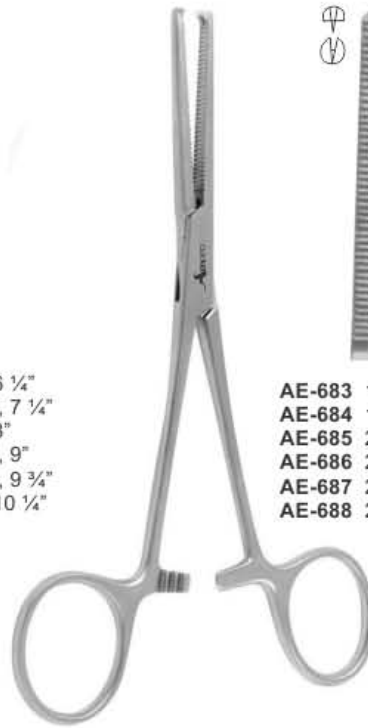

KOCHER-OSHSNER



- AE-683 16cm, 6 ¼"
- AE-684 18.5cm, 7 ¼"
- AE-685 20cm, 8"
- AE-686 22.5cm, 9"
- AE-687 24.0cm, 9 ¾"
- AE-688 26cm, 10 ¼"



- AE-689 16cm, 6 ¼"
- AE-690 18.5cm, 7 ¼"
- AE-691 20cm, 8"
- AE-692 22.5cm, 9"
- AE-693 24.0cm, 9 ¾"
- AE-694 26cm, 10 ¼"

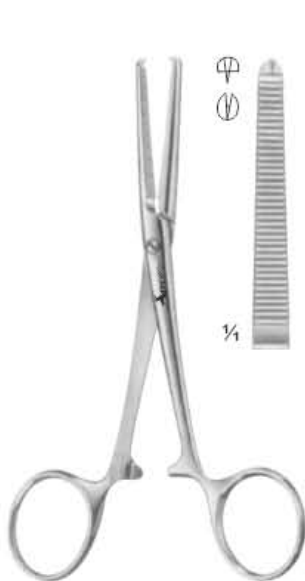

KOCHER
Strong Pattern
AE-695
14.5cm, 5 ¾"



KOCHER



AE-696
13cm, 5 ¼"



AE-697
14cm, 5 ½"



AE-698
14cm, 5 ½"

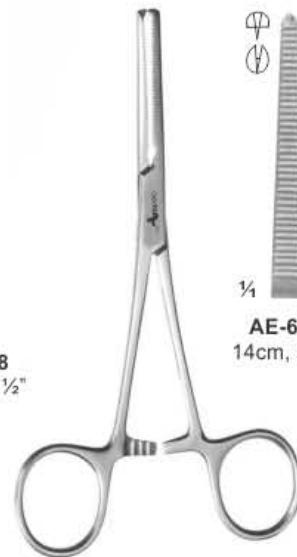

ROCHESTER-OSHSNER



AE-699
14cm, 5 ½"



AE-700
14cm, 5 ½"

HAEMOSTATIC FORCEPS



Arterienklemmen
Pinzas hemostaticas

Pinces hemostatiques
Pinze emostatiche



ROCHESTER-CARMALT

$\frac{1}{4}$
AE-701
16cm, 6 $\frac{1}{4}$ "
AE-702
20cm, 8"

AE-703
16cm, 6 $\frac{1}{4}$ "
AE-704
20cm, 8"



HEISS

$\frac{1}{4}$
AE-705
20cm, 8"

AE-706
20cm, 8"

AE-707
20cm, 8"

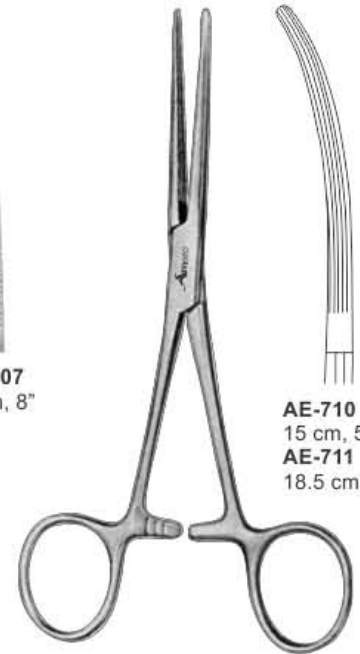

BAINBRIDGE
AE-708 15 cm, 5 $\frac{3}{4}$ "
AE-709 18.5 cm, 7 $\frac{1}{4}$ "

AE-710
15 cm, 5 $\frac{3}{4}$ "
AE-711
18.5 cm, 7 $\frac{1}{4}$ "

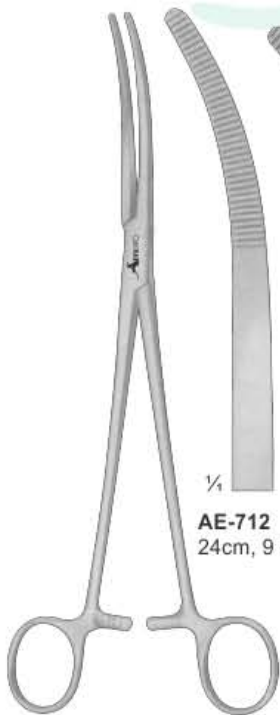

RUMEL

$\frac{1}{4}$
AE-712 24cm, 9 $\frac{1}{2}$ "
AE-713 24cm, 9 $\frac{1}{2}$ "
AE-714 24cm, 9 $\frac{1}{2}$ "
AE-715 24cm, 9 $\frac{1}{2}$ "
AE-716 24cm, 9 $\frac{1}{2}$ "

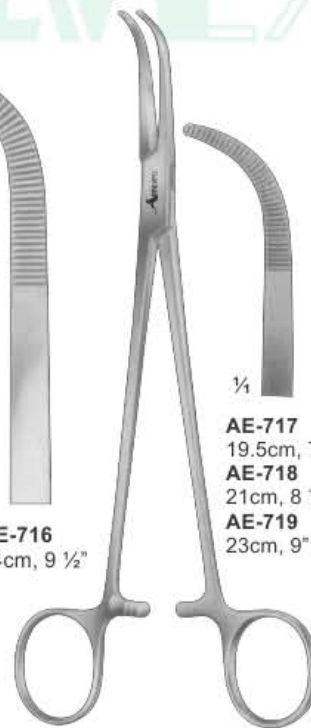

OVERHOLT-GEISSENDOERFER

$\frac{1}{4}$
AE-717 19.5cm, 7 $\frac{3}{4}$ "
AE-718 21cm, 8 $\frac{1}{4}$ "
AE-719 23cm, 9"
AE-720 21cm, 8 $\frac{1}{4}$ "
AE-721 22cm, 8 $\frac{3}{4}$ "
AE-722 22.5cm, 9"
AE-723 22.5cm, 9"
AE-724 26cm, 10 $\frac{1}{4}$ "
AE-725 27cm, 10 $\frac{3}{4}$ "
AE-726 27.5cm, 10 $\frac{3}{4}$ "
AE-727 27cm, 10 $\frac{3}{4}$ "
AE-728 28cm, 11"

HAEMOSTATIC FORCEPS

Arterienklemmen
Pinzas hemostaticas

Pinces hemostatiques
Pinze emostatiche

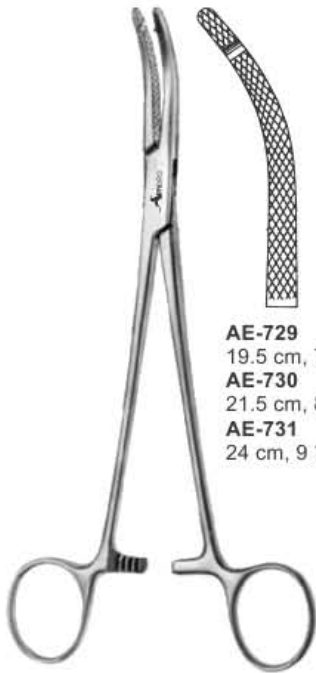

HEANEY

AE-729
19.5 cm, 7 1/2"
AE-730
21.5 cm, 8 1/2"
AE-731
24 cm, 9 1/2"



AE-732
19.5 cm, 7 1/2"
AE-733
21.5 cm, 8 1/2"
AE-734
24 cm, 9 1/2"

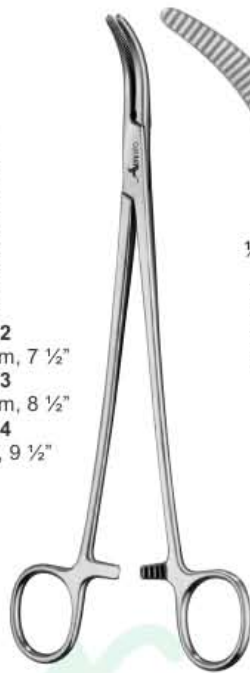

MOYNIHAN



AE-735
23cm, 9"
AE-736
24cm, 9 3/4"



NEGUS



AE-737 **AE-738**
19.5cm, 7 3/4" 19.5cm, 7 3/4"



WERTHEIM-CULLEN

AE-739 60mm
AE-740 80mm
23cm, 9"



WERTHEIM
AE-741
25cm, 10"



WERTHEIM
Parametrium Clamps



AE-742
25cm, 10"



AE-743
24.5cm, 9 3/4"



AE-744
24cm, 9 1/2"



AE-745
22cm, 8 3/4"

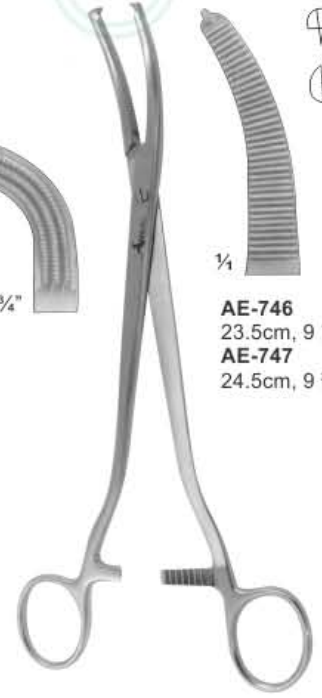

WERTHEIM



AE-746
23.5cm, 9 1/4"
AE-747
24.5cm, 9 3/4"

HAEMOSTATIC FORCEPS, TUBING CLAMPS



Arterienklemmen, Schlauchklemmen
Pinzas hemostaticas, Pinzas para tubos

Pinces hemostatiques, Pinces presse-Tubes
Pinze emostatiche, Pinze serratubi

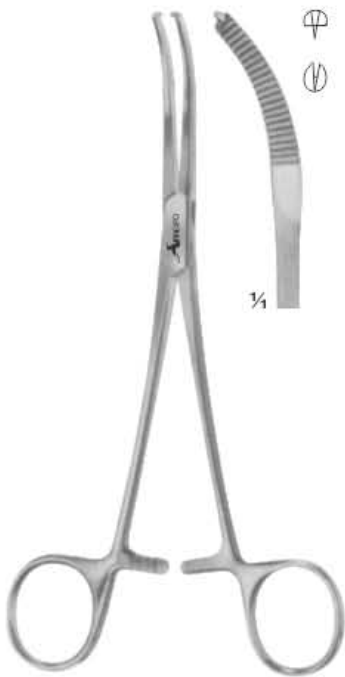

MIKULICZ
AE-748
18.5cm, 7 1/4"



MIKULICZ
AE-749
20.5cm, 8"



MIKULICZ
AE-750
20cm, 8"



MIKULICZ
AE-751
20.5cm, 8"



AE-752
16.5 cm, 6 1/2"
AE-753
18 cm, 7"
Straight, Smooth

PRESBYTERIAN



AE-754
18 cm, 7"
AE-755
20 cm, 8"
Cross Serrated

TUBING

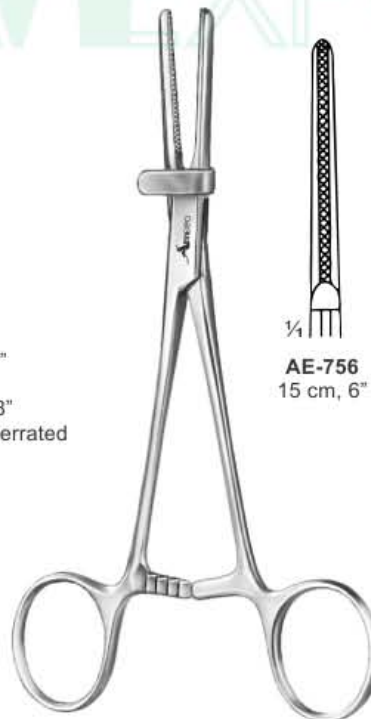

AE-756
15 cm, 6"

TUBING CLAMP
with Protector,
Cross Serrated

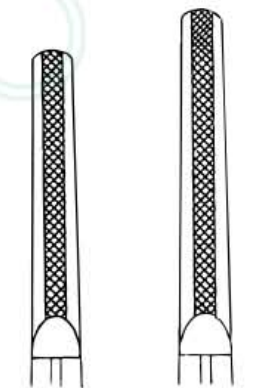

AE-757
18 cm, 7"

AE-758
20 cm, 8"

HAEMOSTATIC FORCEPS

Arterienklemmen
Pinzas hemostaticas

Pinces hemostatiques
Pinze emostatiche



AE-761 AE-762 AE-763
13cm 15.5cm 17.5cm
5 1/4" 6" 7"

FRICKE
Artery Forceps
AE-759
13cm, 5 1/4"

BRYANT
AE-760
13cm, 5 1/4"

LISTER
Sinus Forceps

KRONLENIN
AE-764
13cm, 5 1/4"

PEAN
AE-765
12.5cm, 4 3/4"

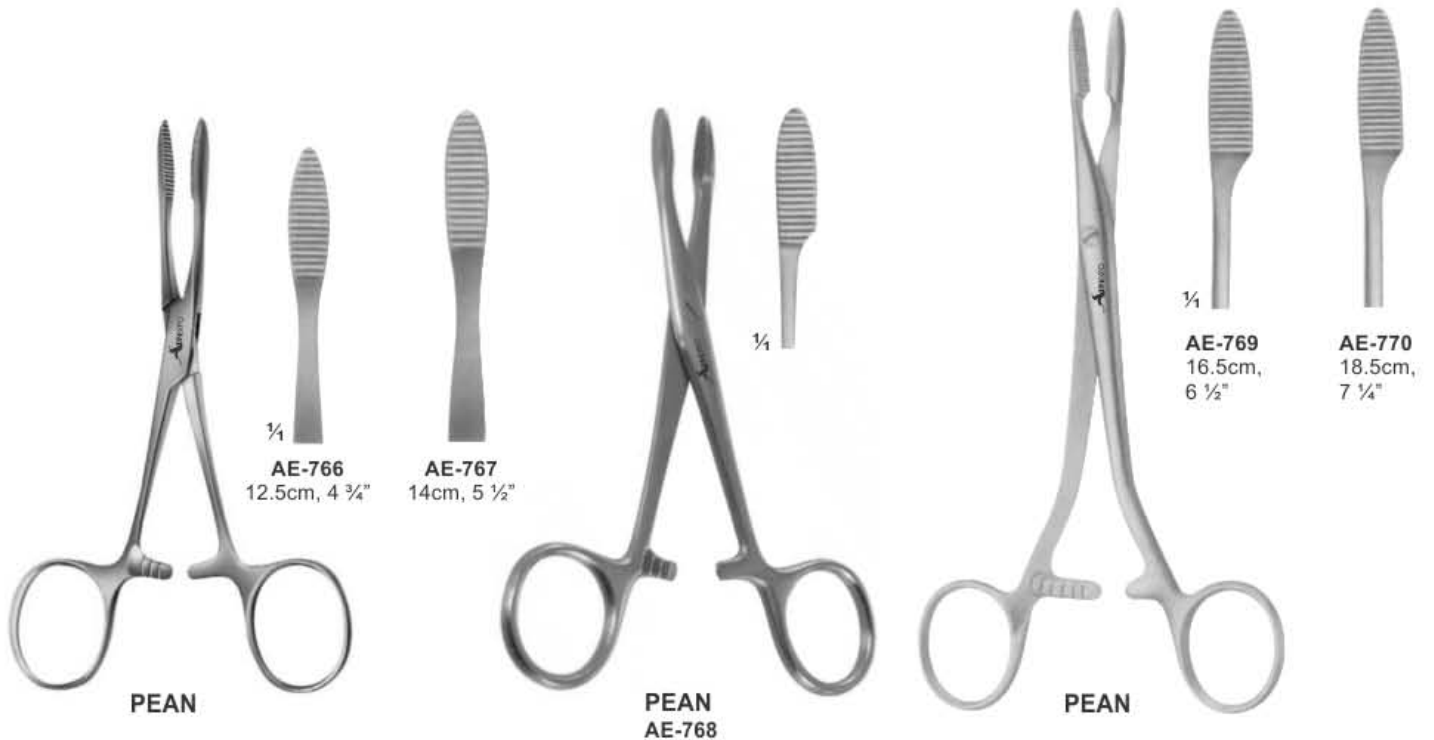

AE-766
12.5cm, 4 3/4"

AE-767
14cm, 5 1/2"

AE-769
16.5cm,
6 1/2"

AE-770
18.5cm,
7 1/4"

PEAN

PEAN
AE-768

PEAN

HAEMOSTATIC FORCEPS

Arterienklemmen
Pinzas hemostaticas

Pinces hemostatiques
Pinze emostatiche



TUFFIER
AE-771
13.0 cm, 5"

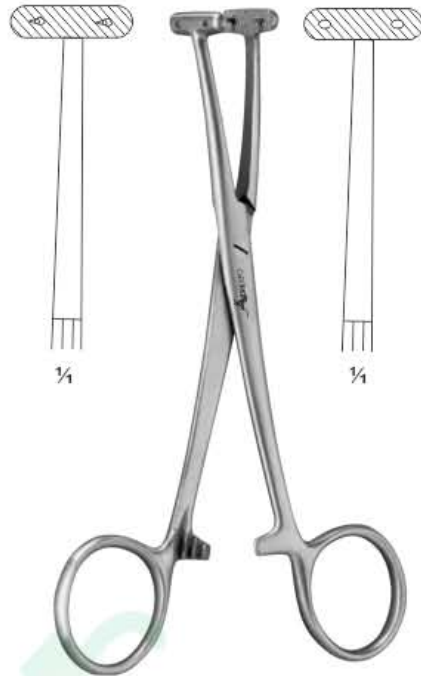

MARTEL
AE-772
14.0 cm, 5 1/2"

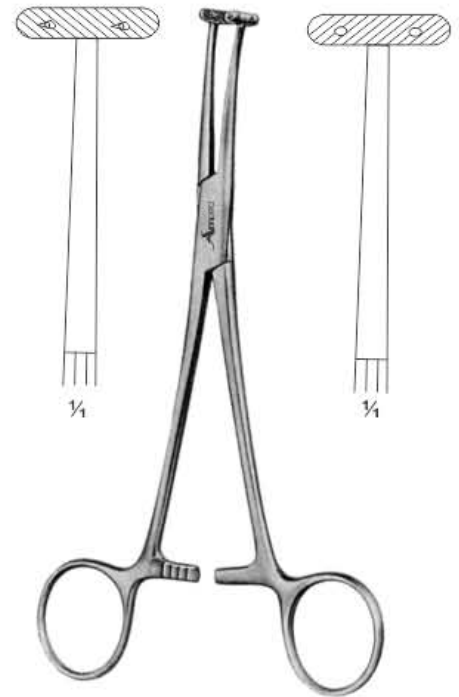

WILLET-MARTEL
AE-773
19.0 cm, 7 1/2"



AE-774
15 cm, 4 3/4"
Slight Curve

PRATT



AE-775
15.5 cm, 6"
Straight

PENNINGTON / SIEZING



AE-776
20 cm, 8"
Straight



CHAPUT
AE-777
13.0 cm, 5"

TOWEL FORCEPS

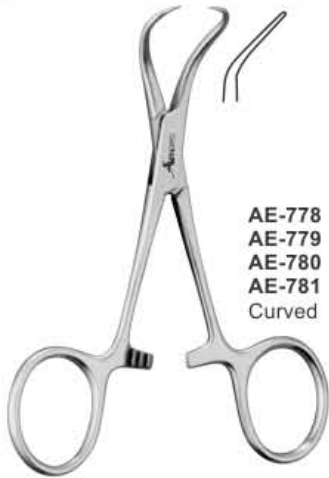

AE-778 8cm
 AE-779 11cm
 AE-780 13cm
 AE-781 15cm
 Curved

Backhaus Towel Forceps



Backhaus Clip Towel Forceps
 AE-782 11cm
 with clip for tubing or cable



Roeder Towel Forceps
 AE-783 13cm
 AE-784 15cm
 Curved, Serrated



Lorna Towel Forceps
 AE-785 9cm
 AE-786 11.4cm
 AE-787 13.5cm



Ball & Socket Towel Forceps
 AE-788 13cm
 Non-perforating



Tohoku Towel Forceps
 AE-789 10cm
 AE-790 13cm
 Non-Perforating



Non-Perforating Towel Forceps
 AE-791 11cm
 AE-792 13cm



Peers-Bertman Towel Forceps
 AE-793 14.5cm
 Serrated



Tischler Biopsy Forceps
 Bule Coated
 AE-794
 21.5cm Shaft

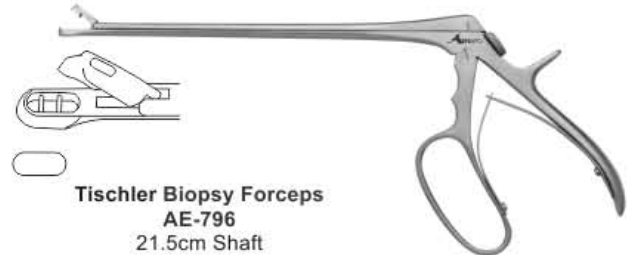

Tischler Biopsy Forceps
 AE-796
 21.5cm Shaft



Tischler Biopsy Forceps
 Gold Coated
 AE-795
 21.5cm Shaft



Tischler Baby Biopsy Forceps
 AE-797
 21.5cm Shaft

DRESSING FORCEPS

Schwammzange
Pinza para tapones

Pince pour éponges
Pinza per tamponi e spunge

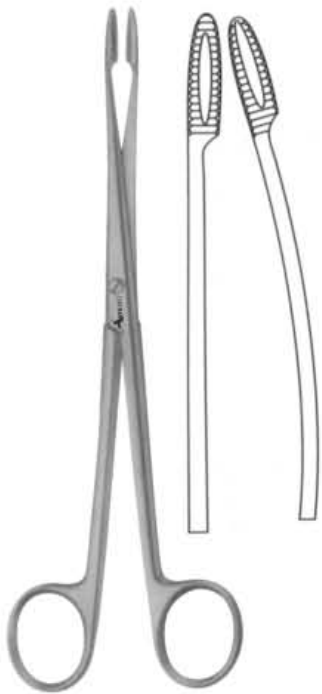

GROSS
AE-798 18cm, 7"
AE-799 20cm, 8"
With Ratchet

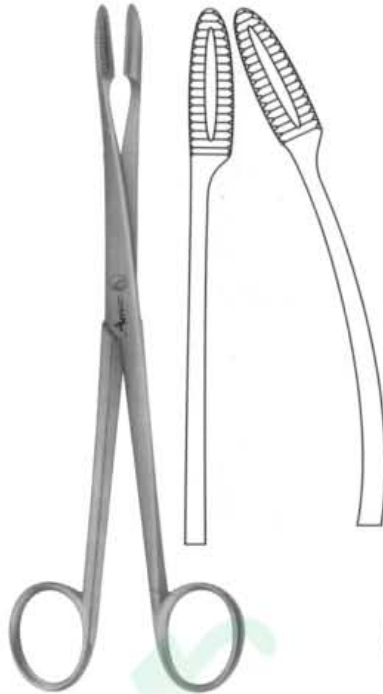

GROSS
Without Ratchet
AE-800
20cm, 8"

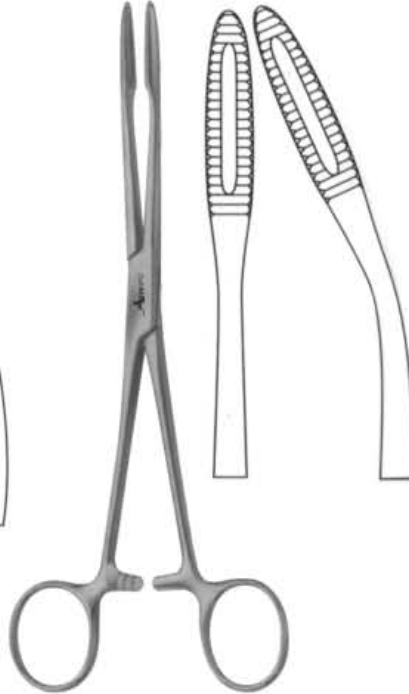

GROSS
With Ratchet
AE-801
20cm, 8"

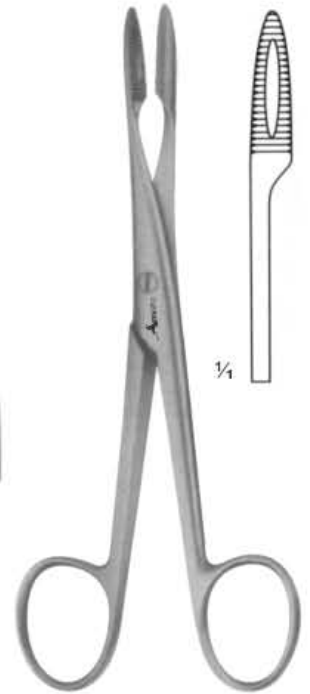

With Ratchet
AE-802
14.5cm, 5 3/4"



SIMS-MAIER
AE-803
28cm, 11"

AE-804
28cm, 11"



COLLIN
AE-805
24cm, 9 1/2"



CHERON
Handles Laterally Angled
AE-806
24cm, 9 1/2"

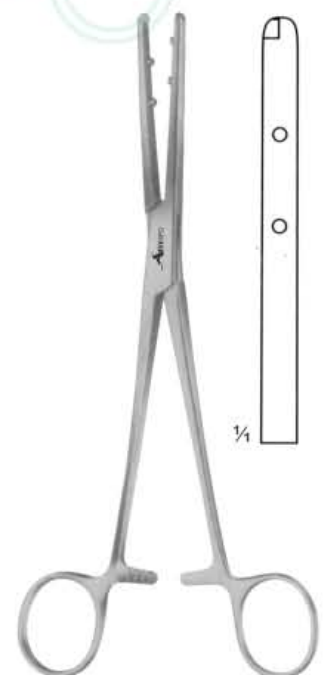

EMMET
AE-807
21cm, 8 1/4"

SPONGE FORCEPS

Schwammzange
Pinza para tapones

Pince pour éponges
Pinza per tamponi e spunge



FOERSTER-BALLEGER
18cm, 7"

AE-808



AE-809



RAMPLEY

AE-810
18cm, 7"



AE-811
25cm, 10"



FOERSTER

AE-812
25cm 10"
Round



AE-813
18cm 7"
AE-814
20cm 8"
AE-815
25cm 10"
Round



AE-816
25cm 10"
Round



AE-817
18cm 7"
AE-818
20cm 8"
AE-819
25cm 10"
Round



COLLIN

AE-820
19.5cm, 7 3/4"

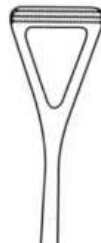

AE-821
23cm, 9"

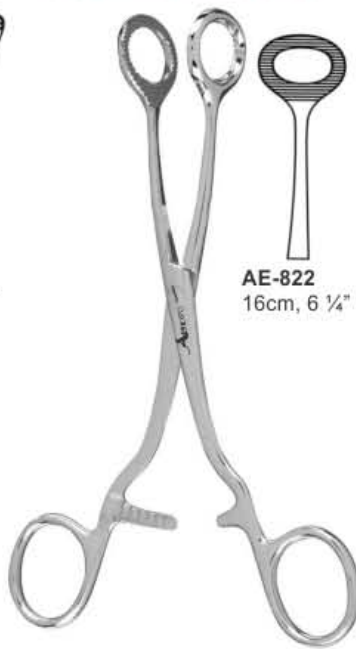

COLLIN

AE-822
16cm, 6 1/4"



AE-823
16cm, 6 1/4"



AE-824
17cm, 6 3/4"



HEYWOOD-SMITH
AE-825
20cm, 8"



NEEDLE HOLDERS

Nadelhalter
Porta-agujas

Porte-agujas
Portaghi

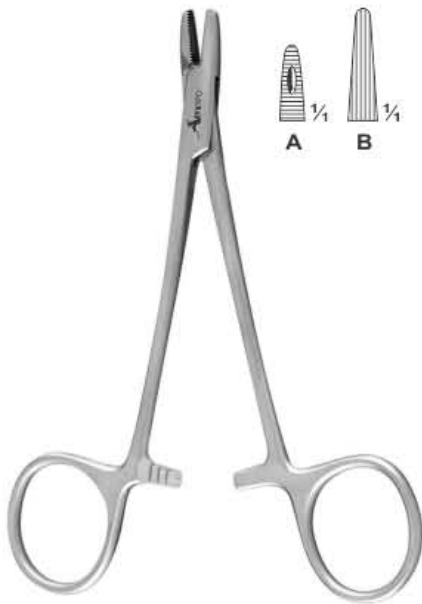

DERF
AE-826 12 cm, 5" A
AE-827 12 cm, 5" B



COLLIER
AE-828 12.5 cm



WEBSTER
AE-829 13cm



M.G. HOSPITAL

AE-830
17.5 cm
Heavy
pattern

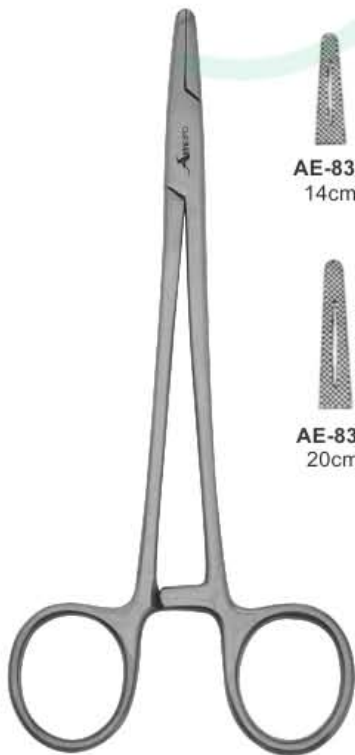

MAYO-HEGAR

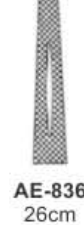
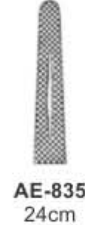

CRILE-WOOD
AE-838 150cm



CRILE-MURRAY
AE-839 15 cm

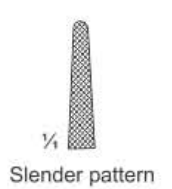

NEEDLE HOLDERS

Nadelhalter
Porta-agujas

Porte-agujas
Portaghi



WRIGHT
AE-840 13cm

BRUCE-CLARKE
AE-841 12.5cm

KILNER
AE-842 13.5 cm

THOMSON WALKER
AE-843 20cm



BOZEMANN
AE-844 20cm

METZENBAUM
AE-845 18cm

FINOCCHIETTO
AE-846 27cm

WANGENSTEEN
AE-847 27cm

NEEDLE HOLDERS



Nadelhalter
Porta-agujas

Porte-agujas
Portaghi



MASSON
AE-848
27 cm, 10 3/4"



SAROT
AE-849
27cm

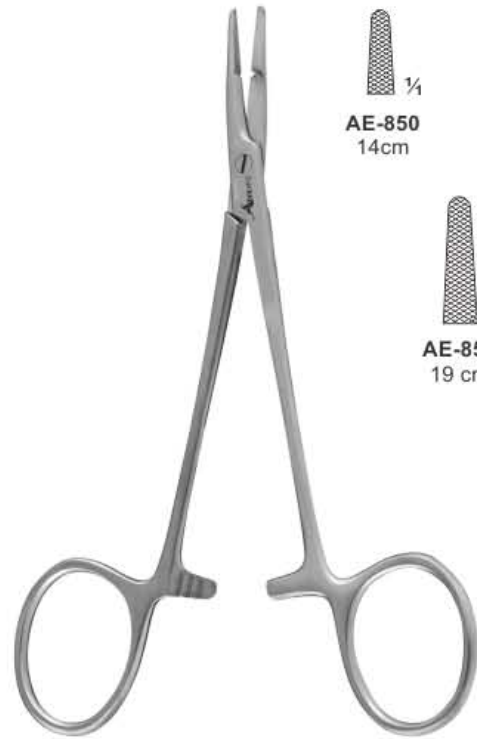

OLSEN

AE-850 14cm
AE-851 16.5 cm
AE-852 19 cm



GILLIES
AE-853 16 cm



MATHIEU



AE-854 11cm
AE-855 14cm
AE-856 17cm



MATHIEU

AE-857 14cm
AE-858 17cm
AE-859 20cm
AE-860 24cm



LANGENBECK
AE-861 18.5cm

NEEDLE HOLDERS T.C.

Nadelhalter
Porta-agujas

Porte-agujas
Portaghi



AE-862
12 cm
Mini profile

DERF



AE-863
13 cm
Mini profile

AE-864
14.5 cm
Mini profile

HEGAR-BAUMGARTNER



AE-865
13 cm
Smooth jaw

AE-866
13 cm
Mini profile

HALSEY



AE-867
12 cm,
AE-868
13 cm
Two Sizes
Smooth jaw

WEBSTER



AE-869
15 cm
Mini profile

CRILE-WOOD



AE-870
13 cm
Mini profile

KILNER

NEEDLE HOLDERS T.C.



Nadelhalter
Porta-agujas

Porte-agujas
Portaghi

WEBSTER AE-871
13 cm
Mini profile

CRILE-WOOD AE-872
15 cm

CRILE-WOOD AE-873
20.5 cm
Mini profile

AE-874
18 cm
Standard profile

AE-875
20 cm
Standard profile

AE-876
26 cm
Standard profile

CRILE-WOOD

SAROT

AE-877
16 cm

AE-878
18 cm

AE-879
20 cm

AE-880
24 cm

AE-881
26 cm

AE-882
30 cm

AE-883
20 cm

AE-884
24 cm

AE-885
26 cm

AE-886
18 cm

AE-887
20 cm

AE-888
23 cm

AE-889
26 cm

AE-890
31 cm

MAYO-HEGAR
Standard profile

HEANEY
Standard profile

DeBAKEY
Delicate pattern
mini profile

NEEDLE HOLDERS T.C.

Nadelhalter
Porta-agujas

Porte-agujas
Portaghi

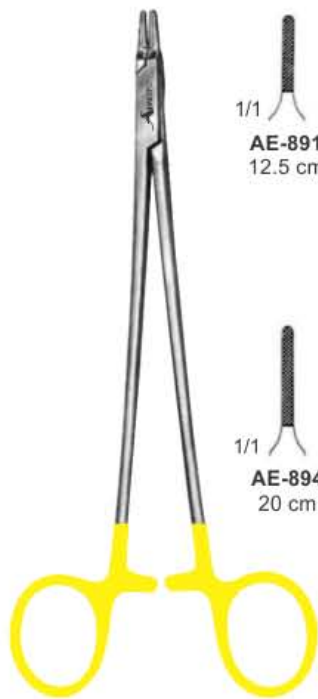

RAYDER
Mini profile

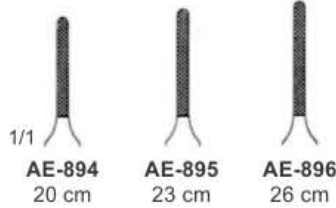

MASSON

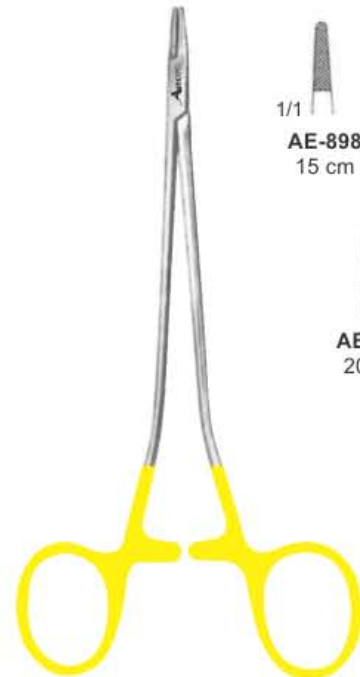
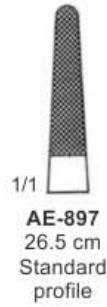

Mini profile
elastic type

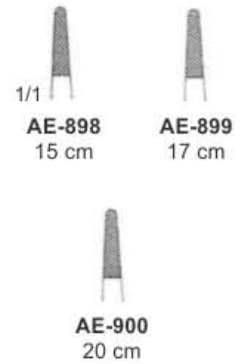

RYDER-VASCULAR
Slender pattern
micro profile

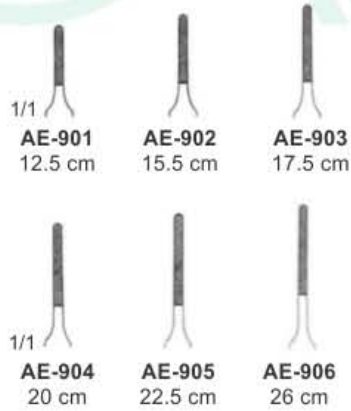

FINOCHIETTO

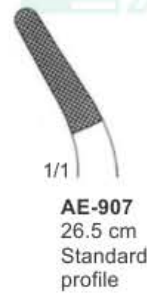

WANGENSTEEN

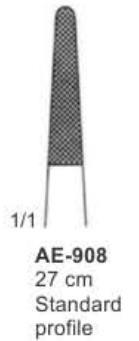

NEEDLE HOLDERS T.C.



Nadelhalter
Porta-agujas

Porte-agujas
Portaghi

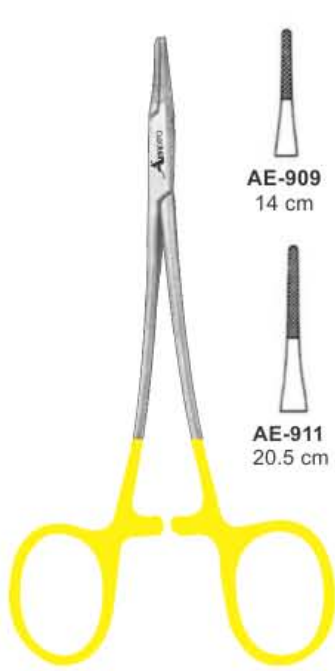

HEGAR-VASCULAR
Micro profile

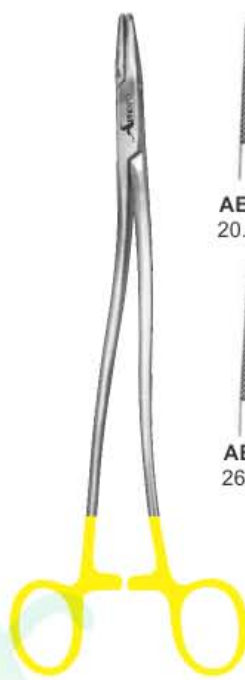

BOZEMANN
Standard profile



HEGAR
Standard profile



STRATTE
Standard profile

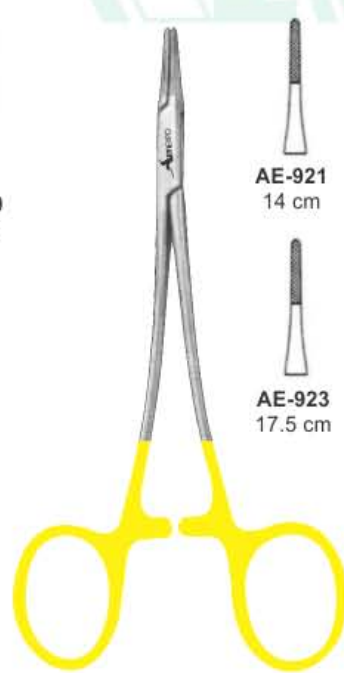

MARTINI
Slender pattern,
micro profile



OLSEN-HEGAR
Standard profile



NEEDLE HOLDERS T.C.

Nadelhalter
Porta-agujas

Porte-agujas
Portaghi



AE-928
11 cm
Smooth jaw

FOSTER-GILLIES



AE-929
15 cm
Mini profile

GILLIES-MINI

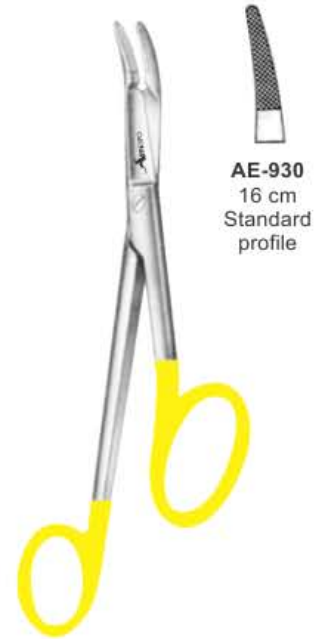

AE-930
16 cm
Standard profile

GILLIES

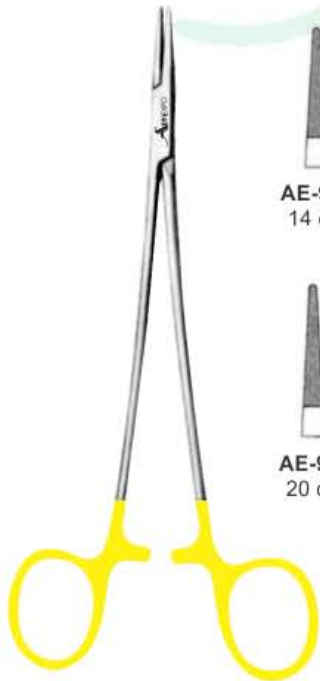

AE-931
14 cm

AE-932
17.5 cm

AE-933
20 cm

AE-934
23 cm

MICROVASCULAR
Slender pattern,
micro profile



AE-935
14 cm

AE-936
16 cm

AE-937
17.5 cm

AE-938
20 cm

MARTINI
Slender pattern,
smooth jaw



Wire Holding Forceps
AE-939 14cm, 15cm

NEEDLE HOLDERS T.C.



Nadelhalter
Porta-agujas

Porte-agujas
Portaghi

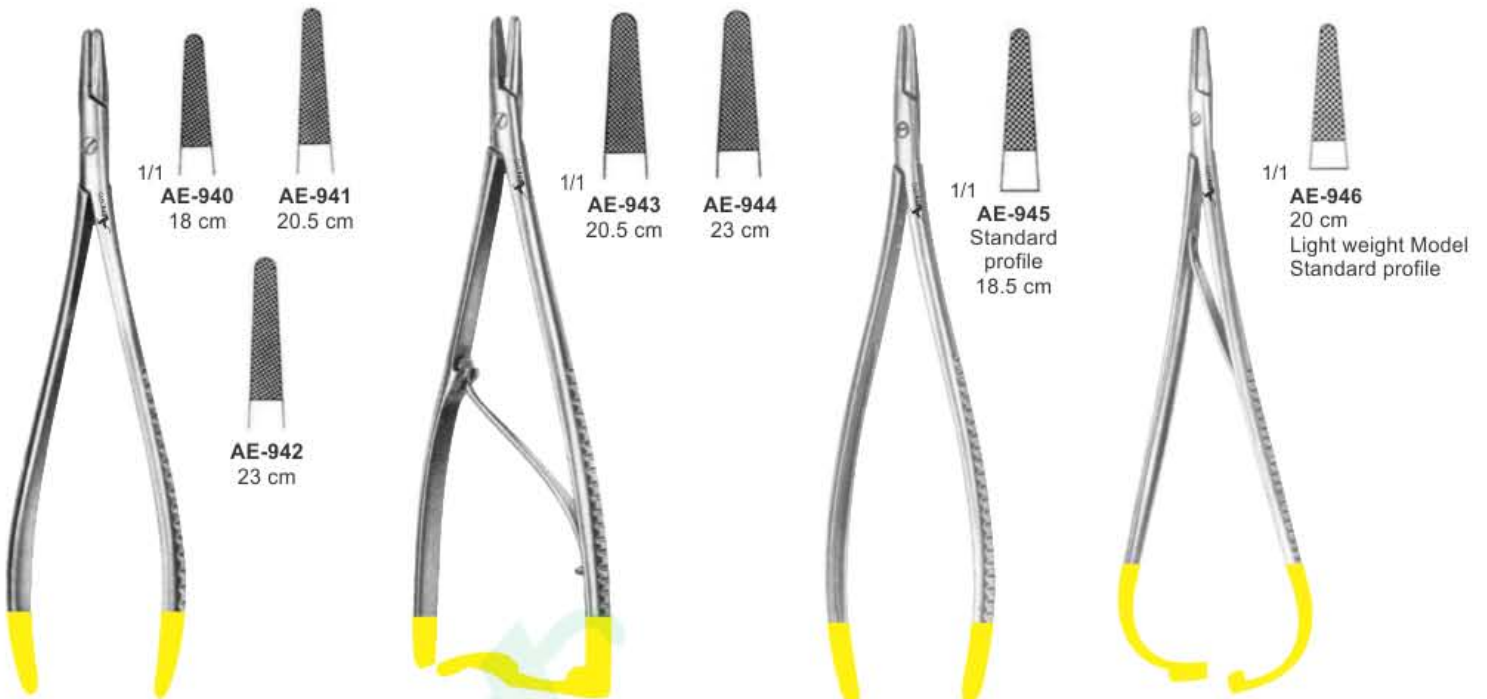

Standard profile

ZWEIFEL
Standard profile

TOENNIS

LICHTENBERG



MATHIEU
Standard profile

MATHIEU
Standard profile

MATHIEU
Standard profile

NEEDLE HOLDERS T.C.

Nadelhalter
Porta-agujas

Porte-agujas
Portaghi

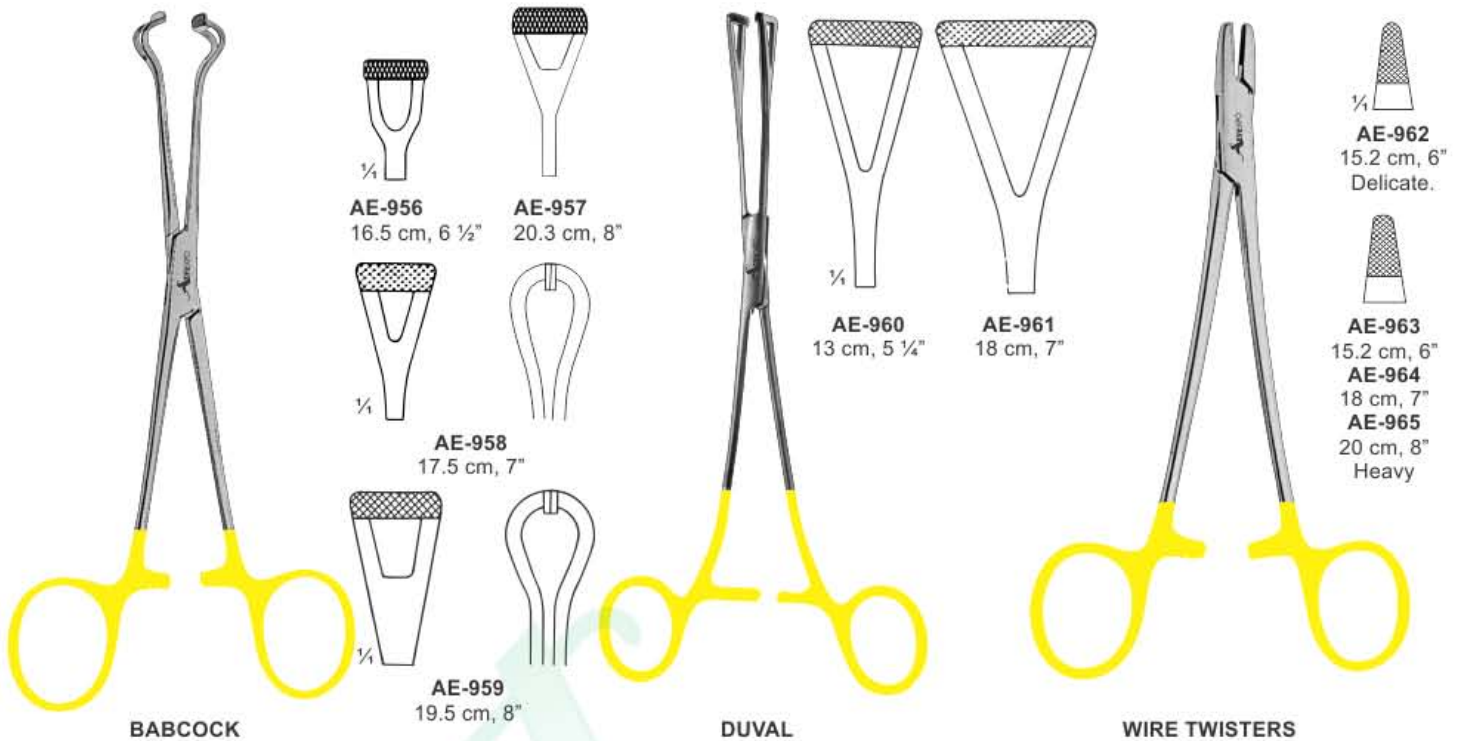

HOOKELETS, RETRACTORS



Wundhäkchen, Wundhaken
Ganchito, Separadores

Crochet, Ecarteurs
Divaricatore, Divaricatori

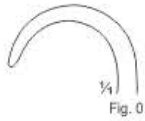

KOCHER
Sharp

- AE-970 22 cm, 8 3/4" 15 x 10 mm Fig. 1
- AE-971 22 cm, 8 3/4" 15 x 15 mm Fig. 2
- AE-972 22 cm, 8 3/4" 15 x 20 mm Fig. 3
- AE-973 22 cm, 8 3/4" 15 x 30 mm Fig. 4
- AE-974 22 cm, 8 3/4" 15 x 40 mm Fig. 5

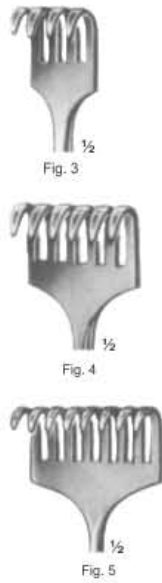
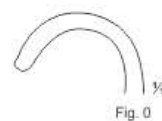

Fig. 3

Fig. 4

Fig. 5



KOCHER
Blunt

- AE-975 22 cm, 8 3/4" 15 x 10 mm Fig. 1
- AE-976 22 cm, 8 3/4" 15 x 15 mm Fig. 2
- AE-977 22 cm, 8 3/4" 15 x 20 mm Fig. 3
- AE-978 22 cm, 8 3/4" 15 x 30 mm Fig. 4
- AE-979 22 cm, 8 3/4" 15 x 40 mm Fig. 5



Fig. 3

Fig. 4

Fig. 5



SENN-MUELLER
AE-980
18 x 6 mm
16 cm, 6 1/4" sharp



MEYERDING
18 cm, 7"



AE-981
18 x 7 mm
Blunt



AE-983
7 x 4 mm
Toothed



AE-985
7 x 4 mm
Saddle Shaped



AE-982
16 x 5 mm
Toothed



AE-984
10 x 3 mm
Blunt



AE-986
10 x 3 mm
Sharp



LANGENBECK
AE-987
22 cm, 8 1/2"



AE-988
25 x 6 mm

AE-989
35 x 11 mm

AE-990
41 x 11 mm

AE-991
70 x 14 mm

AE-992
25 x 6 mm

AE-993
35 x 11 mm

AE-994
41 x 11 mm

AE-995
70 x 14 mm



LANGENBECK
AE-996
22 cm, 8 1/2"



WEITLANER
AE-997
Sharp
11.0 cm



WEITLANER
AE-998
Semi-Sharp
11.0 cm



WEITLANER
AE-999
Blunt
11.0 cm



WEITLANER
AE-1000
Sharp
13.0 cm



WEITLANER
AE-1001
Semi-Sharp
13.0 cm



WEITLANER
AE-1002
Blunt
13.0 cm



MILLIGAN
AE-1003
18.5 mm x 20 mm
Blunt, 3:3
13 cm, 5"



JANSEN
AE-1004 10 cm, 4"
Sharp 3:3
AE-1005 10 cm, 4"
Blunt 3:3



GELPI-LOKTITE
AE-1006
18 cm, 7"

RETRACTORS

Wundhaken
Separadores

Ecarteurs
Divaricatori

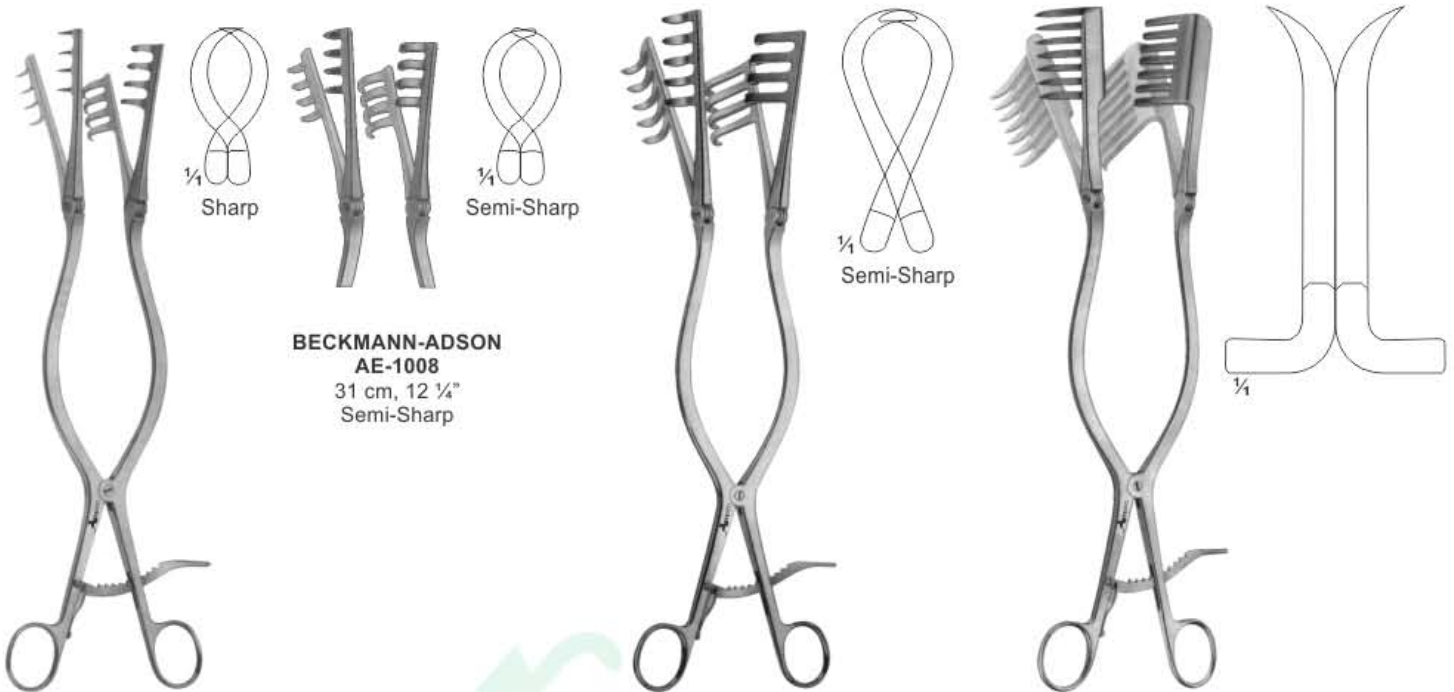

**BECKMANN-ADSON
AE-1008**
31 cm, 12 1/4"
Semi-Sharp

**BECKMANN-ADSON
AE-1007**
31 cm, 12 1/4"
Sharp

**ADSON
AE-1009**
32 cm, 12 1/2"
Semi-Sharp

**BECKMANN-EATON
AE-1010**
32 cm, 12 1/2"
Sharp

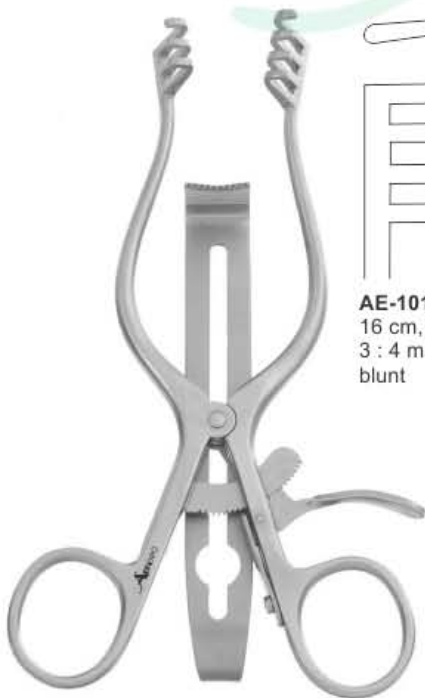

HENLEY

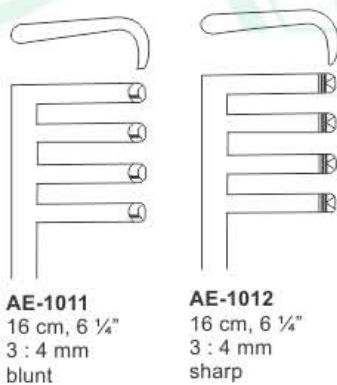

AE-1011
16 cm, 6 1/4"
3 : 4 mm
blunt

AE-1012
16 cm, 6 1/4"
3 : 4 mm
sharp



**MISKIMON
AE-1013** 22 cm, 8 3/4"
33 mm x 38 mm
Sharp, 7:7



ADSON

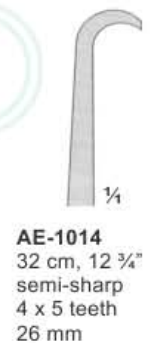

AE-1014
32 cm, 12 3/4"
semi-sharp
4 x 5 teeth
26 mm



**ADSON-BABY
AE-1015**
16 cm, 6 1/4" sharp
3 x 4 teeth
13 mm

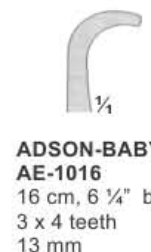

**ADSON-BABY
AE-1016**
16 cm, 6 1/4" blunt
3 x 4 teeth
13 mm

RETRACTORS



Beckman-Weitlaner Retractor
AE-1017
 16.5cm 6 1/2"
 3 x 4 Sharp prongs



Beckman-Weitlaner Retractor
AE-1018
 16.5cm 6 1/2"
 3 x 4 Blunt prongs

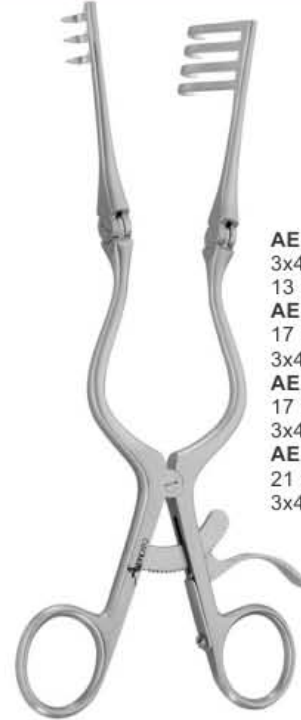

Cone Retractor

AE-1019 31cm, 12"
 3x4 Blunt prongs,
 13 mm x 14.5 mm
AE-1020 16.5cm, 6 1/2"
 17 mm x 19 mm
 3x4 Sharp prongs,
AE-1021 16.5cm, 6 1/2"
 17 mm x 19 mm
 3x4 Blunt prongs,
AE-1022 20cm, 8"
 21 mm x 210 mm
 3x4 Blunt prongs,



Beckman Retractor
AE-1023 31.7cm 12 1/2"
 Spread 3.5cm 5 3/8" 4 x 4
 Sharp prongs, Arm length
 8.5cm 3 3/8"



Beckman Retractor
AE-1024 31cm 12 1/4"
 4 x 4 Sharp prongs 27mm,
 Side Blade 1.7cm 5/8" deep,



Beckman Retractor
AE-1025 31cm 12 1/4"
 4 x 4 Blunt prongs 27mm,
 Side Blade 1.7cm 5/8" deep,

THORACIC/CARDIOVASCULAR



Thorax-cardiovasculaire
Thorax-cardiovascular

Torace-cardiovascolare
Torax-cardiovascular

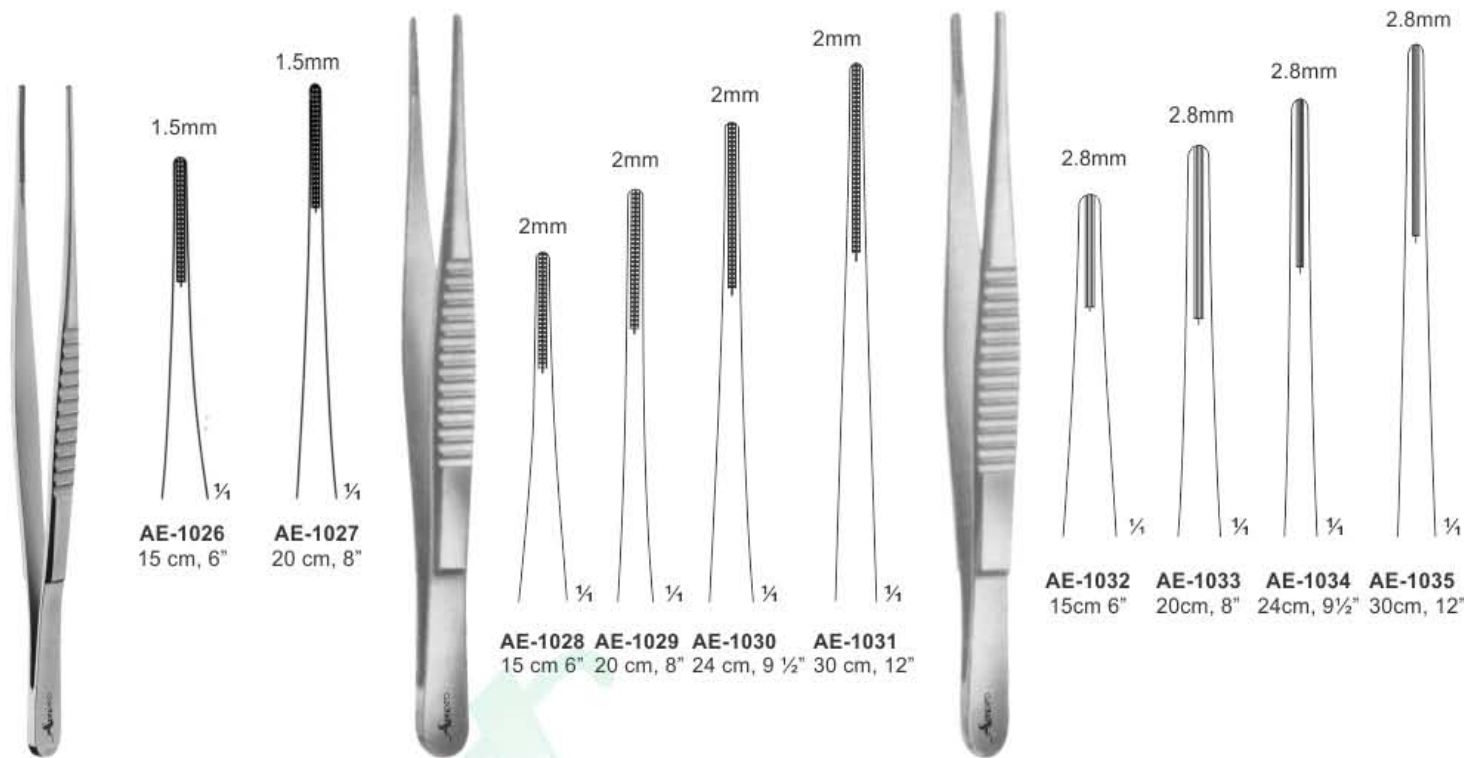

DE BAKEY
CARDIOVASCULAR
FORCEPS

DE BAKEY

DE BAKEY



DE BAKEY













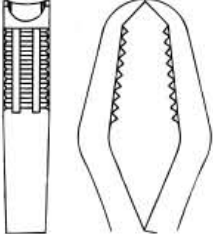
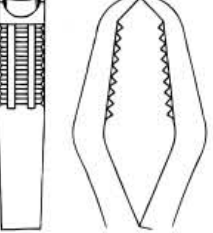



DE BAKEY

DE BAKEY

BONE HOLDING FORCEPS

Repositionszangen
Pinzas para reposición

Pinces à réduction
Pinze per riposizioni

		 <p>without ratchet</p>  <p>with ratchet</p>			
<p>Lane Bone Holding Forceps AE-1041 31.5cm AE-1042 39cm</p>	<p>Lane Bone Holding Forceps AE-1043 33cm AE-1044 45cm</p>		<p>Kern Bone Holding Forceps AE-1045 17cm AE-1046 21cm</p>	<p>Kern Bone Holding Forceps AE-1047 17cm AE-1048 21cm</p>	<p>Lambotte Bone Holding Forceps AE-1049 19cm AE-1050 23cm AE-1051 26cm</p>
					
<p>Lambotte Bone Holding Forceps AE-1052 22cm AE-1053 26cm AE-1054 33cm</p>	<p>VERBRUGGE AE-1055 18 cm, 7"</p>	<p>VERBRUGGE AE-1056 18 cm, 7"</p>	<p>VERBRUGGE AE-1057 25 cm, 10" AE-1058 26 cm, 10 ¼" AE-1059 27 cm, 10 ½"</p>	<p>VERBRUGGE AE-1060 25 cm, 10" AE-1061 26 cm, 10 ¼" AE-1062 27 cm, 10 ½"</p>	
					
<p>VERBRUGGE AE-1063 18 cm, 7"</p>	<p>VERBRUGGE AE-1064 25 cm, 10" AE-1065 26 cm, 10 ¼" AE-1066 27 cm, 10 ½"</p>	<p>REIL AE-1067 17 cm, 7"</p>	<p>REDUCTION FORCEPS AE-1068 20 cm, 8" with Points</p>	<p>AE-1069 17 cm, 7" For fingers, with drill Guide for Kirschner Wires up to 1 mm</p>	

BONE HOLDING FORCEPS, REPOSITION FORCEPS



*Knochenfasszange, Repositionszangen
Pinzas para hueso, Pinzas para reposición*

*Daviers porte-so, Pincas à réduction
Tenaglie per ossa, Pinze per riposizioni*



HOLDING FORCEPS
AE-1070
13 cm, 5"



RATCHET FIXATION FORCEPS
AE-1071 14.5 cm, 6"



MALLEOLAR FORCEPS
AE-1072
20 cm, 8"



PATELLA FORCEPS
AE-1073
18.5 cm, 7 1/4"



REDUCTION FORCEPS
AE-1074 16 cm, 6 1/2"
AE-1075 24 cm, 9 1/2"
with Thread Lock



REPOSITION FORCEPS
AE-1076
23 cm, 9"



LOWMANN BONE CLAMP
AE-1077 18 cm, 7"
AE-1078 20 cm, 8"
AE-1079 22 cm, 8 3/4"



LOWMAN-HOGLUND
AE-1080 17.5 cm, 7"

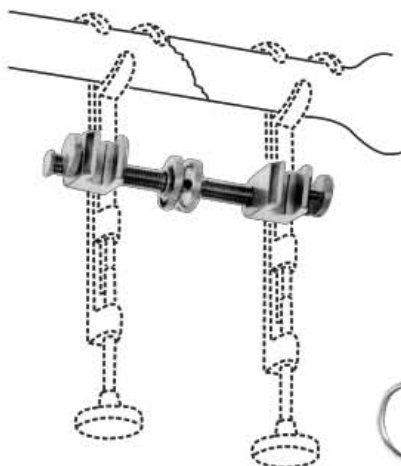

GERSTER
AE-1081 18 cm, 7"
AE-1082 20 cm, 8"
AE-1083 22 cm, 9"

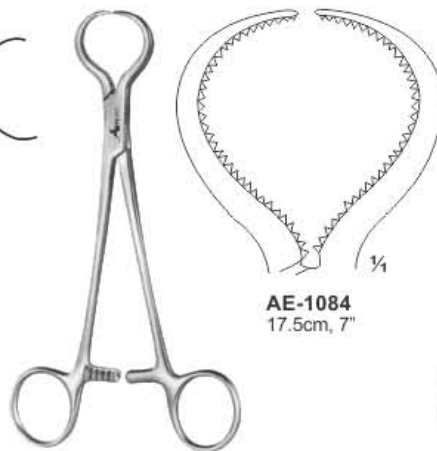

AE-1084
17.5cm, 7"

LEWIN



ORTHO FORCEPS
AE-1085 13 cm, 5"



AE-1086
13.5 cm, 5 1/2"
Angled Serrated

ORTHO FORCEPS

MALLETS

Hämmer
Martillos

Maillets
Martelli



plane (nylon)
convex (steel)
plastic handle
Head 30mm Ø
Weight 675 Gr.

**MALLET
AE-1087**
26 cm, 10 1/2"



plastic handle
Head 42 / 30mm Ø
Weight 530 Gr.

**MALLET
AE-1088**
26 cm, 10 1/4"



plastic handle
Head 30mm Ø
Weight 480 Gr.

**MALLET
AE-1089**
24 cm, 9 1/2"



Plastic Handle
Head 30mm Ø
Weight 510 Gr.

**MALLET
AE-1090**
26 cm, 10 1/4"

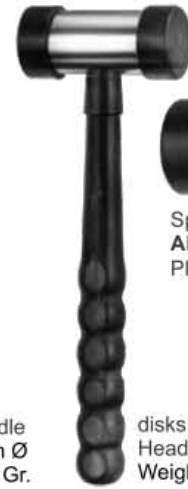

disks and plastic handle
Head 37mm Ø
Weight 370 Gr.

**MALLET
AE-1091**
22.5 cm, 9"



Spare Facing (pair)
AE-1092
Plastic



made of plastic
Head 30mm Ø
Weight 125 Gr.

**MALLET
AE-1093**
18 cm, 7"



made of plastic
with lead filling
Head 42mm Ø
Weight 400 Gr.
Head 42mm Ø
Weight 250 Gr.

**MALLET
AE-1094**
26 cm, 10 1/4"



made of plastic
with lead filling
Head 42mm Ø
Weight 250 Gr.

**MALLET
AE-1095**
26 cm, 10 1/4"



**WILLIGER
AE-1096**
24 cm, 9 1/2"

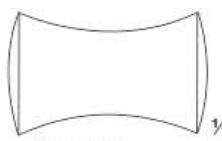

AE-1097
Head 26 mm Ø
Weight 300 Gr.
AE-1098
Head 28 mm Ø
Weight 340 Gr.
AE-1099
Head 30 mm Ø
Weight 400 Gr.



AE-1101
Head 25 mm Ø
Weight 120 Gr.
AE-1102
Head 30 mm Ø
Weight 180 Gr.
AE-1103
Head 35 mm Ø
Weight 260 Gr.



AE-1105
Head 19 mm Ø
Weight 230 Gr.
AE-1106
Head 25 mm Ø
Weight 260 Gr.

**LUCAE
AE-1104**
19 cm, 7 1/2"



**WILLIGER
AE-1107**
16.5 cm, 6 1/2"
Head 20 mm Ø
weight 140 Gr.



**PARTSCH
AE-1108**
18 cm, 7"

Head 22mm Ø
Weight 200 Gr.



**MEAD
AE-1109**
17 cm, 6 3/4"



Spare Facings
AE-1110

AE-1111
with interchangeable
Plastic dicks
Head 26 mm Ø
Weight 320 Gr.



**HERBERT
AE-1112**
19 cm, 7 1/2"

for ulnar head
prosthesis
plastic handle
Head 25mm Ø
Weight 300 Gr.



**VICKERS
AE-1113**
19 cm, 7 3/4"

nylon disks
plastic handle
Head 25mm Ø
Weight 300 Gr.

BONE CURETTES



Scharfe Löffel
Cucharillas cortantes

Curettes tranchantes
Curette taglianti



BRUNS

- **AE-1114**
17 cm, 7"
000
- **AE-1116**
17 cm, 7"
0
- **AE-1118**
17 cm, 7"
2
- **AE-1120**
17 cm, 7"
4
- **AE-1122**
17 cm, 7"
6
- **AE-1115**
17 cm, 7"
00
- **AE-1117**
17 cm, 7"
1
- **AE-1119**
17 cm, 7"
3
- **AE-1121**
17 cm, 7"
5



**HIBBS-SPRATT /
ANGLED**

- **AE-1123**
22.5 cm, 9"
000
- **AE-1125**
22.5 cm, 9"
0
- **AE-1127**
22.5 cm, 9"
2
- **AE-1129**
22.5 cm, 9"
4
- **AE-1131**
22.5 cm, 9"
6
- **AE-1124**
22.5 cm, 9"
00
- **AE-1126**
22.5 cm, 9"
1
- **AE-1128**
22.5 cm, 9"
3
- **AE-1130**
22.5 cm, 9"
5



**HIBBS-SPRATT /
STRAIGHT**

- **AE-1132**
22.5 cm, 9"
000
- **AE-1134**
22.5 cm, 9"
0
- **AE-1136**
22.5 cm, 9"
2
- **AE-1138**
22.5 cm, 9"
4
- **AE-1140**
22.5 cm, 9"
6
- **AE-1133**
22.5 cm, 9"
00
- **AE-1135**
22.5 cm, 9"
1
- **AE-1137**
22.5 cm, 9"
3
- **AE-1139**
22.5 cm, 9"
5



WILLIGER
AE-1141
13.25 cm, 5 1/2"
Double Ended
00/0



**SPRATT /
HOLLOW HANDLE**

- **AE-1142**
17 cm, 7"
00000
- **AE-1145**
17 cm, 7"
00
- **AE-1148**
17 cm, 7"
2
- **AE-1143**
17 cm, 7"
0000
- **AE-1146**
17 cm, 7"
0
- **AE-1149**
17 cm, 7"
3
- **AE-1144**
17 cm, 7"
000
- **AE-1147**
17 cm, 7"
1
- **AE-1150**
17 cm, 7"
4
- **AE-1151**
17 cm, 7"
5



VOLKMANN

- **AE-1152**
17 cm, 7"
0000
- **AE-1155**
17 cm, 7"
0
- **AE-1158**
17 cm, 7"
3
- **AE-1153**
17 cm, 7"
000
- **AE-1156**
17 cm, 7"
1
- **AE-1159**
17 cm, 7"
4
- **AE-1154**
17 cm, 7"
00
- **AE-1157**
17 cm, 7"
2
- **AE-1160**
17 cm, 7"
5
- **AE-1161**
17 cm, 7"
6



VOLKMANN

- **AE-1162**
13 cm, 5"
Double Ended
6.2 mm & 6.7 mm
- **AE-1163**
16 cm, 6 1/2"
Double Ended
7 mm & 9 mm
- **AE-1164**
20 cm, 8"
Double Ended
9.1 mm & 11.1 mm

BONE CURETTES

Scharfe Löffel
Cucharillas cortantes

Curettes tranchantes
Curette taglianti



- 3.6 mm
AE-1165
- 4.4 mm
AE-1166
- 5.2 mm
AE-1167
- 6.0 mm
AE-1168

AE-1165 To
AE-1168
25 cm, 10"



UFFENORDE Left
AE-1169
17.5 cm, 7"



UFFENORDE Right
AE-1170
17.5 cm, 7"



SIMON
24 cm, 9 1/2"

- Fig.1
AE-1171
- Fig.2
AE-1172
- Fig.3
AE-1173
- Fig.4
AE-1174
- Fig.5
AE-1175
- Fig.6
AE-1176



BRUNS
23 mm, 9"

- Fig.1
AE-1177
- Fig.2
AE-1178
- Fig.3
AE-1179
- Fig.4
AE-1180
- Fig.5
AE-1181
- Fig.6
AE-1182
- Fig.7
AE-1183
- Fig.8
AE-1184
- Fig.9
AE-1185



WILLIGER
13.5 cm, 5 1/4"

- AE-1186
- AE-1187
- AE-1188



MARTINI
13.5 cm, 5 1/4"

- AE-1189
- AE-1190
- AE-1191



JANSEN
AE-1192
16 cm, 6 1/4"



JANSEN
AE-1193
15 cm, 6"

BONE RONGEURS



Hohlmeißelzangen
Pinzas gubias

Pincas-gouges
Pinze-sgorbie



LEMPERT
AE-1194 19 cm, 7 1/2" straight
AE-1195 19 cm, 7 1/2" curved



LEMPERT

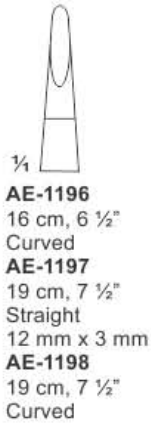

1/4
AE-1196
16 cm, 6 1/2"
Curved
AE-1197
19 cm, 7 1/2"
Straight
12 mm x 3 mm
AE-1198
19 cm, 7 1/2"
Curved



ADSON
AE-1199
20 cm, 8" Straight
15 mm x 7.5 mm



BANE

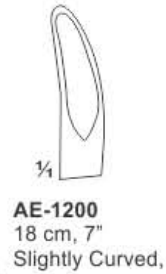

1/4
AE-1200
18 cm, 7"
Slightly Curved,



HAKANSSON
AE-1201
15.5 cm, 6"



1/4
AE-1202
23 cm, 9"

STILLE-RUSKIN



1/4
AE-1203
24cm, 9 1/2"

LEKSELL-STILLE



1/4
AE-1204
24cm, 9 1/2"



1/4
AE-1205
22cm, 8 3/4"

STILLE-LUER



1/4
AE-1206
22cm, 8 3/4"

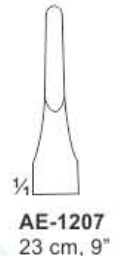

1/4
AE-1207
23 cm, 9"

ECHLIN / STILLE-LUER

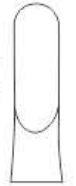

AE-1208
23 cm, 9"



BEYER RONGEUR
AE-1209
18 cm, 7" curved

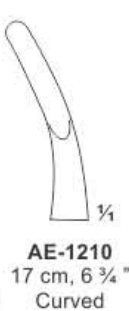

1/4
AE-1210
17 cm, 6 3/4"
Curved

MAYFIELD

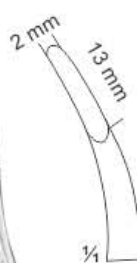

1/4
AE-1211
15.25 cm, 6"
2 x 13 mm

KLEINERT-KUTZ

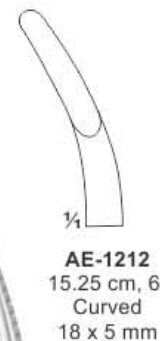

1/4
AE-1212
15.25 cm, 6"
Curved
18 x 5 mm

RUSKIN-MINI



1/4
AE-1213
18 cm, 7"
Slightly Curved
16.5 x 5.5 mm

RUSKIN

BONE RONGEURS

Hohlmeißelzangen
Pinzas gubias

Pinces-gouges
Pinze-sgorbie



AE-1214
15.25 cm, 6"
Straight

BÖHLER



AE-1215
15.25 cm, 6"
Slight Curve



BEYER



AE-1216
18 cm, 7"
Curved



ZAUFAL-JANSEN



AE-1217
18 cm, 7"
Slightly Curved



SEMB

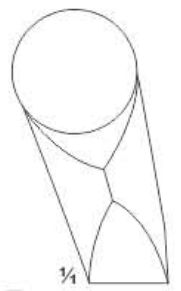

AE-1218
22.5 cm, 9"



AE-1219
23 cm, 9"
Duckbill
17mm x 6mm

STILLE



ECHLIN
23 cm, 9"



AE-1220
2 mm



AE-1221
3 mm



AE-1222
4 mm



LEKSELL
AE-1223 3 mm
AE-1224 5 mm
AE-1225 8 mm
22 cm, 8 3/4"



MAYFIELD
AE-1226
17 cm, 6 3/4"



RUSKIN RONGEUR
AE-1227
curved



MARQUARDT
AE-1228
20 cm, 8"



STILLE-LUER
Rongeur Forceps



AE-1229
23 cm, 9"
AE-1230
27 cm, 10 1/2"
straight



AE-1231
23 cm, 9"
AE-1232
27 cm, 10 1/2"
curved



STILLE RONGEUR
FORCEPS
AE-1233
23 cm, 9"
Double-Action
jaws 3mm wide
Jaws angled to side



SAUERBRUCH
31 cm, 12 1/4"



AE-1234
Round
20 mm



AE-1235
Straight
20 mm

BONE CUTTING FORCEPS



Knochensplitterzangen
Pinzas cortantes para hueso

Pinces coupantes à os
Cesoie per ossa



AE-1236
14cm, 5½"



AE-1237
17cm, 6¾"



AE-1238
19cm, 7½"
AE-1239
22cm, 8¾"



LISTON



AE-1240
14 cm, 5 ½"



AE-1241
17 cm, 6 ¾"



AE-1242
19 cm, 7 ½"



AE-1243
22 cm, 8 ¾"



MARKWALDER

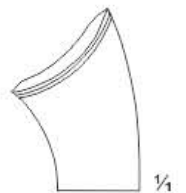

AE-1244
20 cm, 8"



AE-1245
15 cm, 6"
Straight,



AE-1246
16cm, 6½"



AE-1247
15 cm, 6"
Straight



AE-1248
15 cm, 6"
Angled



AE-1249
19cm, 7½" Straight
AE-1250
19cm, 7½" Curved



AE-1251
27cm, 10½"
Straight



CLEVELAND
AE-1252
17cm, 6¾"



CLEVELAND
AE-1253
15cm, 6"



LISTON

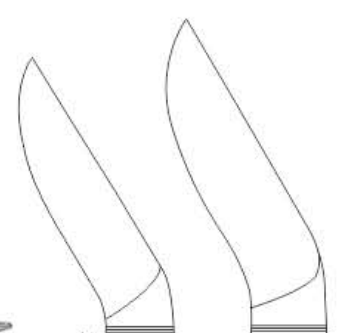

AE-1254
23cm, 9"
Angled



AE-1255
27cm, 10½"
Angled

BONE CUTTING FORCEPS

Knochensplitterzangen
Pinzas cortantes para hueso

Pinces coupantes à os
Cesoie per ossa

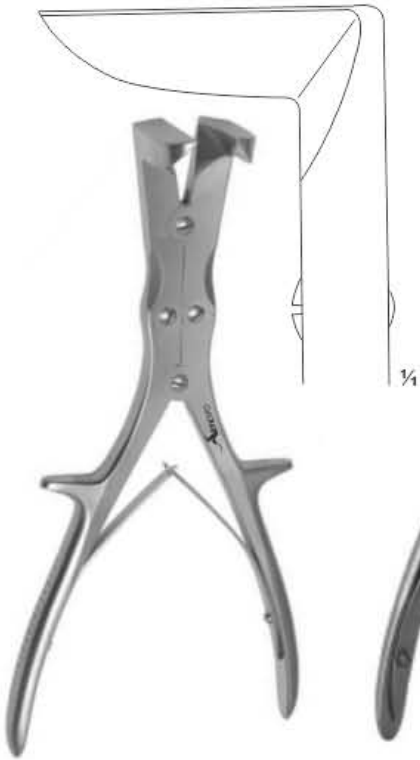

LISTON-STILLE
AE-1256
26 cm, 10 1/4"



Mc INDOE
AE-1257
17.5 cm, 7"



HORSLEY
Bone Cutting Forceps
AE-1258
25 cm, 10"



LISTON-KEY (HORSLEY)
AE-1259
26.5 cm, 10 1/2"
Angled, 28 mm



COTTLE-KAZANJIAN
AE-1260
19 cm, 7 1/2"

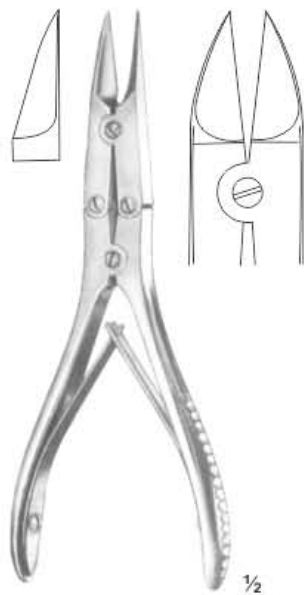

AE-1261
15 cm, 5 3/4"

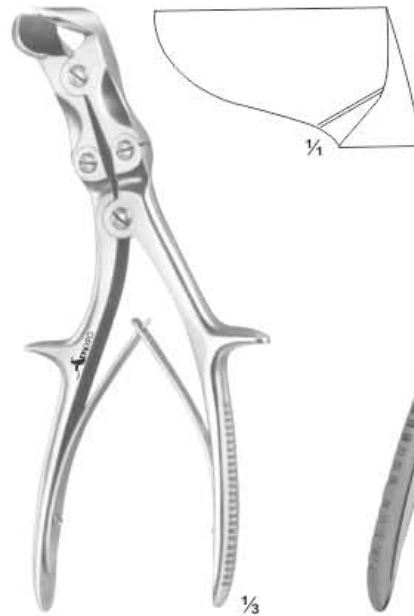

SEMB
AE-1262
24 cm, 9 1/2"



**RUSKIN BONE SPLITTING
FORCEPS**
AE-1263
20 cm, 8", Double-Action

LAMINECTOMY RONGEURS



Laminektomieztangen
Pinzas Para Laminectomía

Pinces Pour Laminectomie
Pinze Per Laminectomia

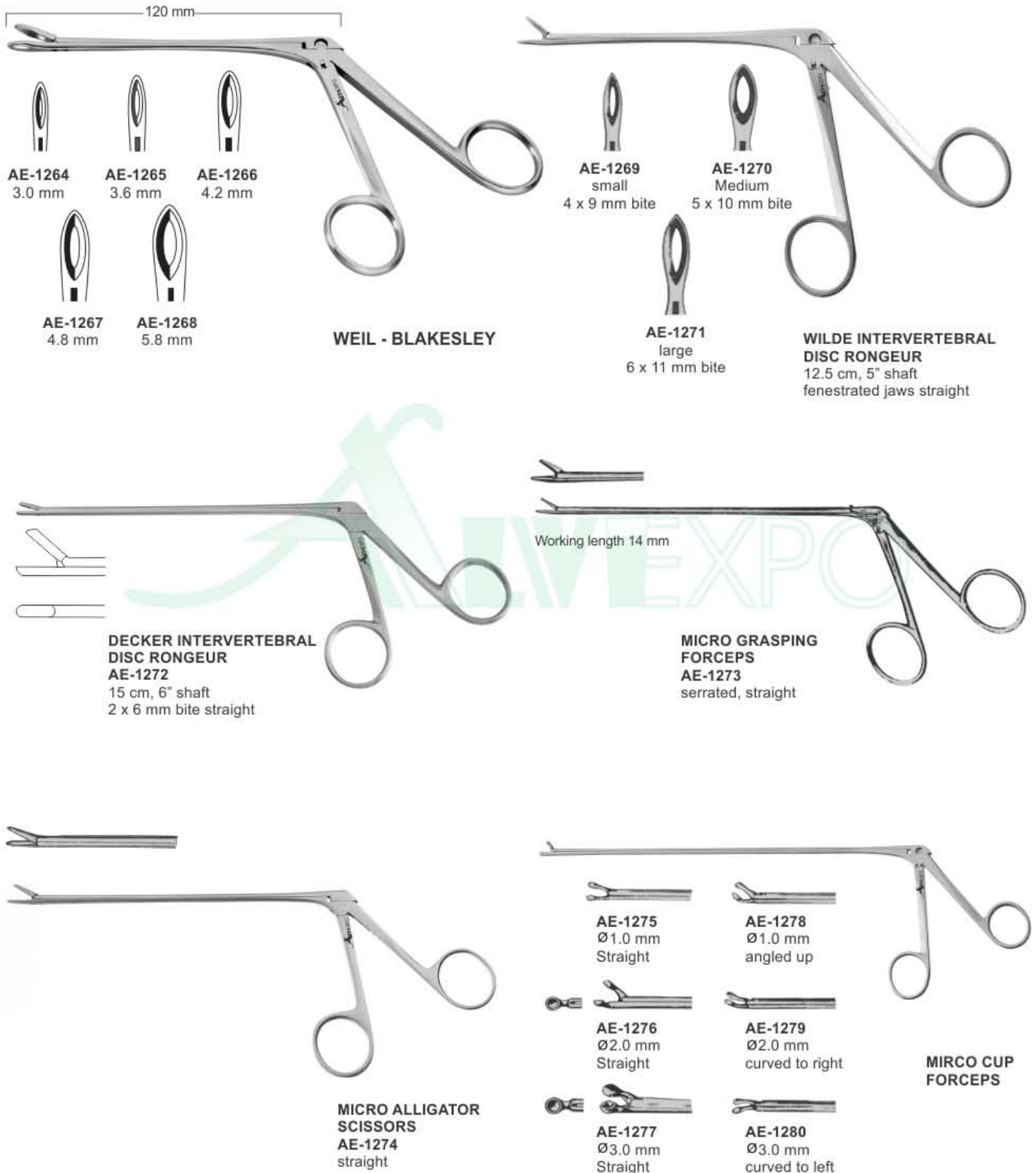



AE-1281
Grasping Forceps
Ø 3 mm



AE-1282
Cup Forceps
Ø 2 mm



AE-1283
Alligator Scissors
Ø 2 mm

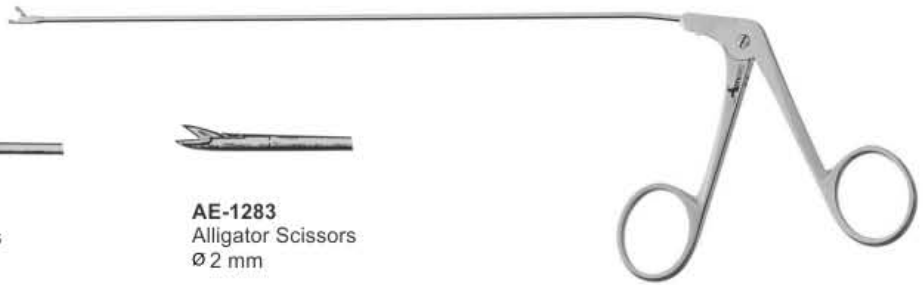

MICRO ALLIGATOR FORCEPS
with tubular shaft
18 cm, 7"

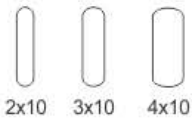

2x10 3x10 4x10

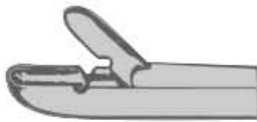

Straight Shaft	180 mm
Bite 2 x 10 mm	AE-1284
Bite 3 x 10 mm	AE-1285
Bite 4 x 10 mm	AE-1286



Angled - up Shaft	180 mm
Bite 2 x 10 mm	AE-1287
Bite 3 x 10 mm	AE-1288
Bite 4 x 10 mm	AE-1289

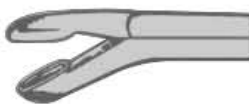

Angled - down Shaft	180 mm
Bite 2 x 10 mm	AE-1290
Bite 3 x 10 mm	AE-1291
Bite 4 x 10 mm	AE-1292

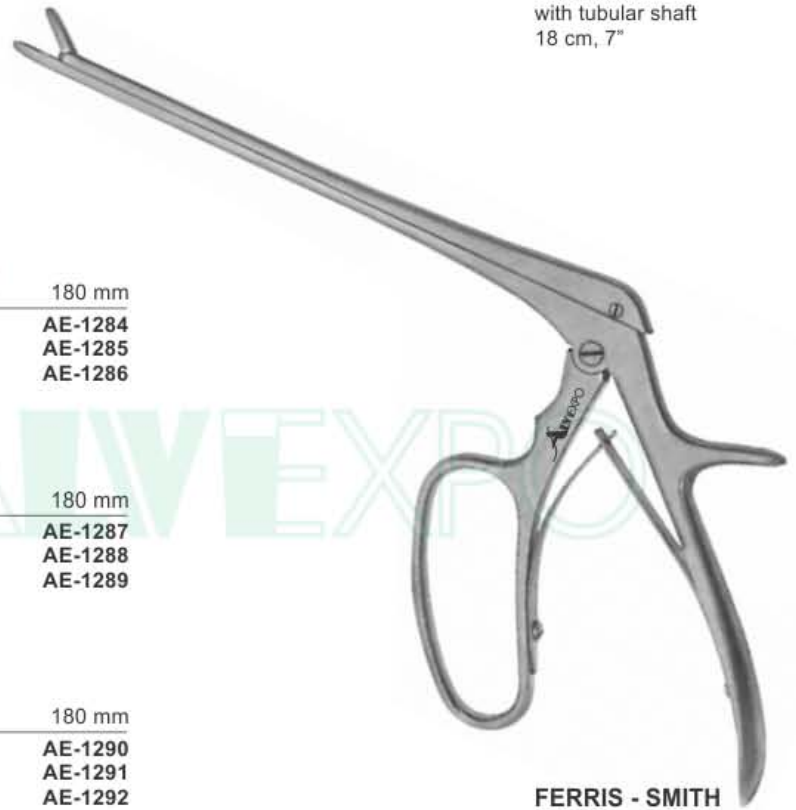

FERRIS - SMITH



4 mm 5 mm 6 mm

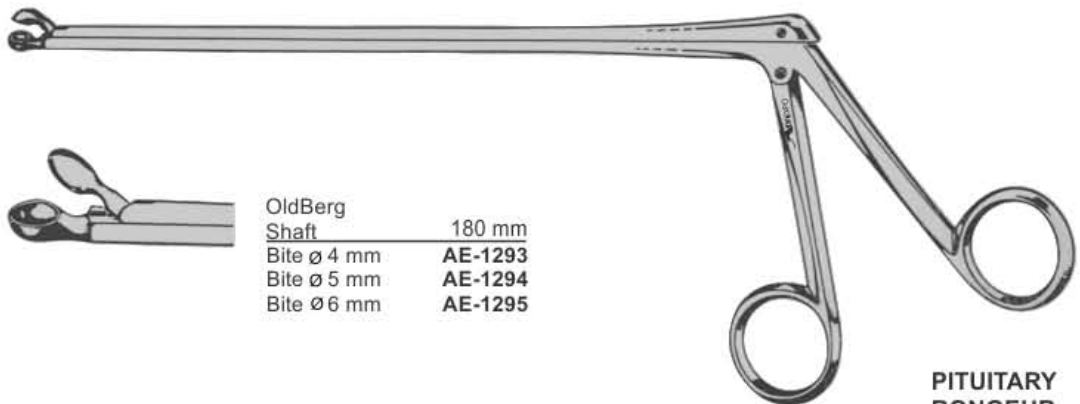

OldBerg Shaft	180 mm
Bite Ø 4 mm	AE-1293
Bite Ø 5 mm	AE-1294
Bite Ø 6 mm	AE-1295

PITUITARY RONGEUR

LAMINECTOMY PUNCHES



Laminektomiestanzen
Pinzas Cortantes Para Laminectomía

Pinces Emporte-pièces à Laminectomie
Pinze Taglienti Per Laminectomia

2.0 mm 3.0 mm 3.5 mm

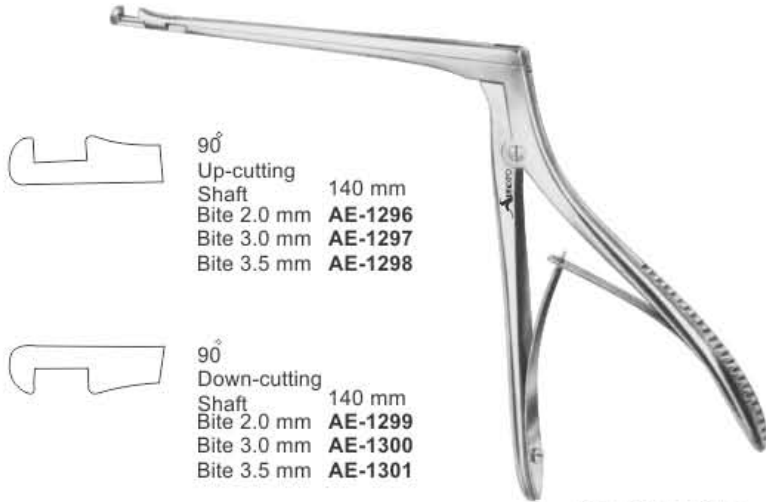

90°
Up-cutting
Shaft 140 mm
Bite 2.0 mm AE-1296
Bite 3.0 mm AE-1297
Bite 3.5 mm AE-1298

90°
Down-cutting
Shaft 140 mm
Bite 2.0 mm AE-1299
Bite 3.0 mm AE-1300
Bite 3.5 mm AE-1301

HAJEK-KOFLER

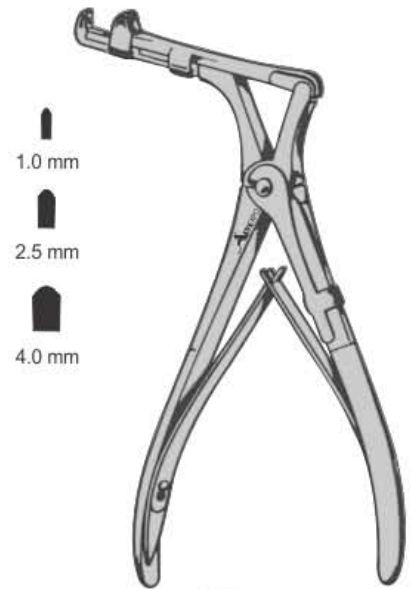

1.0 mm
2.5 mm
4.0 mm

CITELLI
AE-1302 1.0 mm
AE-1303 2.5 mm
AE-1304 4.0 mm



160 mm, 6 1/4"

HAJEK-KOFLER
AE-1305
3.5 mm

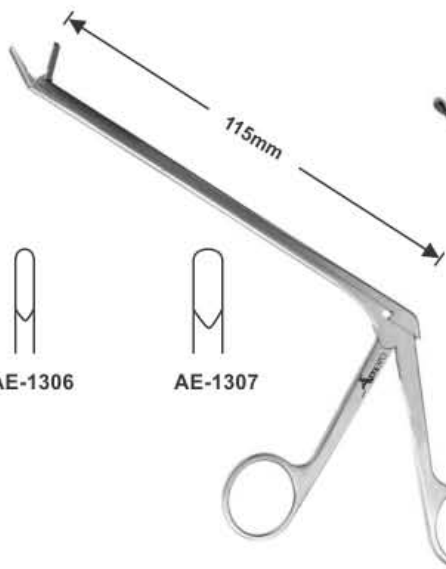

AE-1306
AE-1307

SPURLING-LOVE
AE-1306 28cm
AE-1307 28cm



OLDBERG
AE-1308 25cm

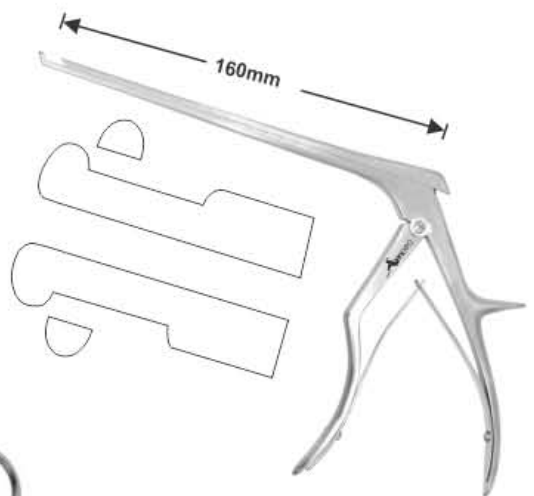

COLCLOUGH
AE-1309 27cm UP CUTTING
AE-1310 27cm DOWN CUTTING



LOVE-KERRISON
LAMINECTOMY PUNCH



Forward 90° Regular Footplate

□	2 mm bite forward	
	AE-1311	150 mm
	AE-1312	200 mm

□	3 mm bite forward	
	AE-1313	150 mm
	AE-1314	200 mm

□	4 mm bite forward	
	AE-1315	150 mm
	AE-1316	200 mm

□	5 mm bite forward	
	AE-1317	150 mm
	AE-1318	200 mm

□	6 mm bite forward	
	AE-1319	150 mm
	AE-1320	200 mm



Up 40° Regular footplate

□	2 mm bite up	
	AE-1321	150 mm
	AE-1322	200 mm

□	3 mm bite up	
	AE-1323	150 mm
	AE-1324	200 mm

□	4 mm bite up	
	AE-1325	150 mm
	AE-1326	200 mm

□	5 mm bite up	
	AE-1327	150 mm
	AE-1328	200 mm

□	6 mm bite up	
	AE-1329	200 mm



Down 90° Regular footplate

□	3 mm bite down	
	AE-1330	150 mm
	AE-1331	200 mm

□	4 mm bite down	
	AE-1332	150 mm
	AE-1333	200 mm

□	5 mm bite down	
	AE-1334	150 mm
	AE-1335	200 mm

ALLIGATOR EAR FORCEPS



Alligator-ohrfaßzangen
Pinces crocodiles à oreilles

Pinze alligatore per orecchi
Pinzas de boca de cocodrilo para el oído



HARTMANN-WULLSTEIN
AE-1336



HARTMANN-WULLSTEIN
AE-1337



HARTMANN
AE-1338
AE-1339



HARTMANN
AE-1340
AE-1341



HARTMANN-NOYES
AE-1342



DUCKBILL
AE-1343



WEINGÄRTNER
AE-1344



HARTMANN
AE-1345 = 2.0 mm
AE-1346 = 2.5 mm
AE-1347 = 3.0 mm



HARTMANN
AE-1348 = 2.0 mm
AE-1349 = 2.5 mm
AE-1350 = 3.0 mm



STRÜMPEL
AE-1351



HARTMAN
AE-1352



HARTMANN
AE-1353



HARTMANN-HOFFMANN
AE-1354

NASAL SPECULUM

Nasenspekula
Especulos Nasaes

Spéculums Nasaux
Specoli Nasali



VIENNA NASAL SPECULUM
AE-1355 - Infant
AE-1356 - Child
AE-1357 - Adult
14 cm, 5 1/2"

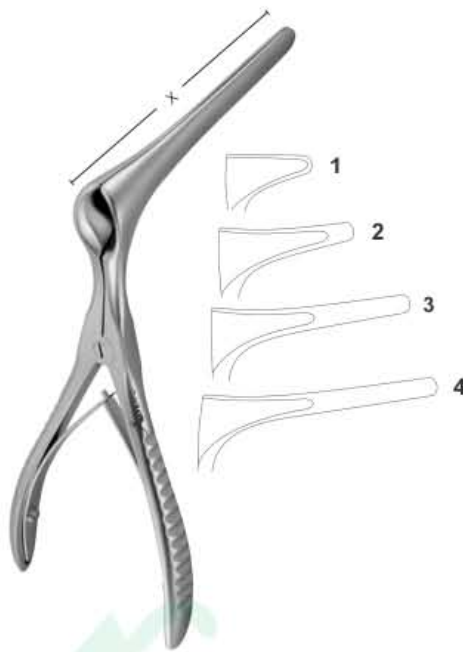

KILLIAN NASAL SPECULUM
AE-1358 35 mm 2" Small blade
AE-1359 50 mm 3" Medium blade
AE-1360 75 mm
AE-1361 90 mm
13 cm, 5 1/4"



THUDICHUM (Golfsmith)

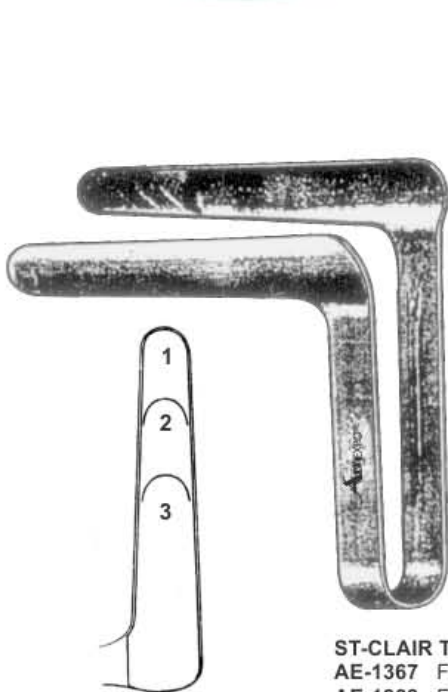

ST-CLAIR THOMSON
AE-1367 Fig 1
AE-1368 Fig 2
AE-1369 Fig 3

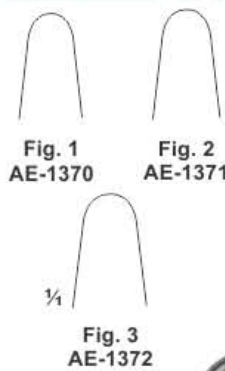

VOLTOLINI (Duplay)



YANKAUER
AE-1373
19cm

SEPTUM FORCEPS, TONSIL PUNCHES



Nasenpolyenzangen, Tonsillenzangen
Pinzas Para Pólipos Nasaes, Pinzas Para Amígdalas

Pinces À Polyepes Nasaux, Pinces Pour Amygdalas
Pinze Per Polipi Nasali, Pinze Per Tonsille

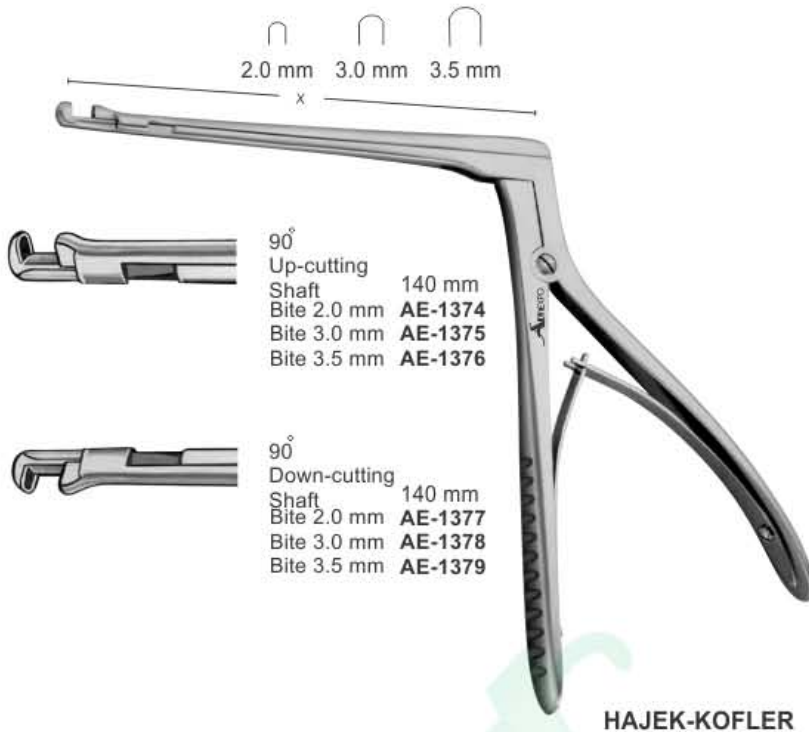

¼
AE-1380
up cutting
3 x 3 mm

AE-1381
up cutting
4 x 4 mm

AE-1382
up cutting
5 x 5 mm

AE-1383
up cutting
6 x 6 mm

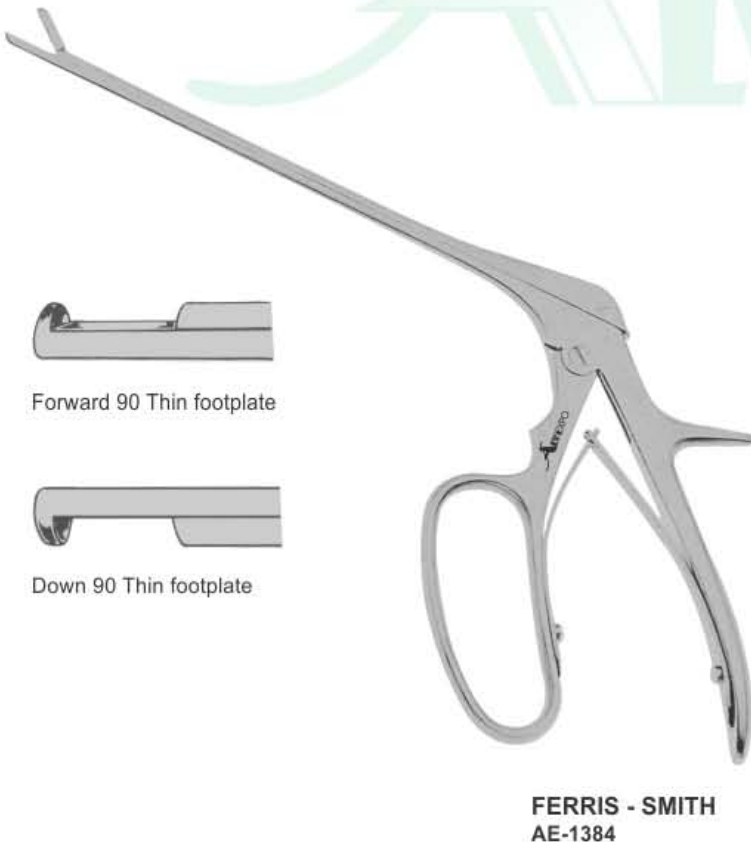

AE-1385
19 cm, 7 ½"
Double Action
5 x 15mm tip



INTESTINAL & TISSUE GRASPING FORCEPS

Darm-und Gewebefasszangen
Pinzas Para Intestinos y Tejidos

Pinces Pour Saisir Intestins et Tissus
Pinze Per Afferrare Intestino e Tessuti



ALLIS
AE-1386
20 cm, 8"

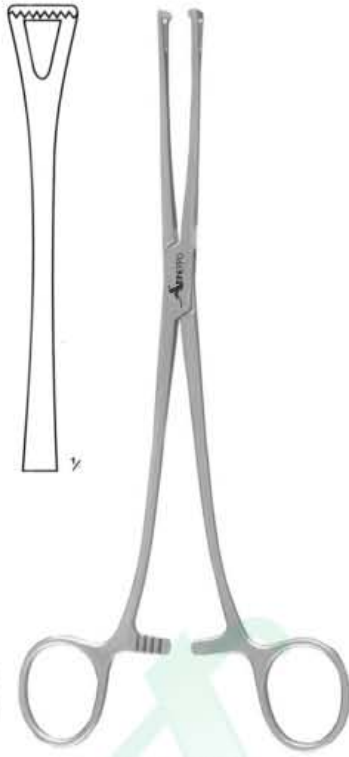

LOCKWOOD
AE-1387
20 cm, 8"



ALLIS ADAIR
AE-1388
15.5 cm



LOCKWOOD
AE-1389
20cm 8"



JUDD-ALLIS
AE-1390
3 x 4 teeth
19.5 cm, 7 3/4"



LITTLEWOOD
AE-1391
19 cm, 7 1/2"



STILLE
AE-1392
20 cm, 8"



LANE
AE-1393 12.5 cm
AE-1394 15.0 cm
AE-1395 19.0 cm

POLYOUS GRASPING FORCEPS, ANASTOMOSIS



Polypenfasszange, Darm-anastomosenklemmen

Pince Pour Saisir Polypes, Pincés-clamps Pour Anastomose Intestinale

Pinza Para Coger Pólipos, Clamps Para Anastomosis Intestinales

Pinze Per Afferrare Polipi, Pinze Per Anastomosi Intestinali

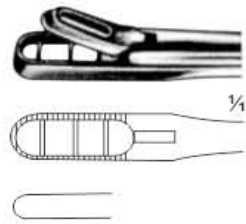
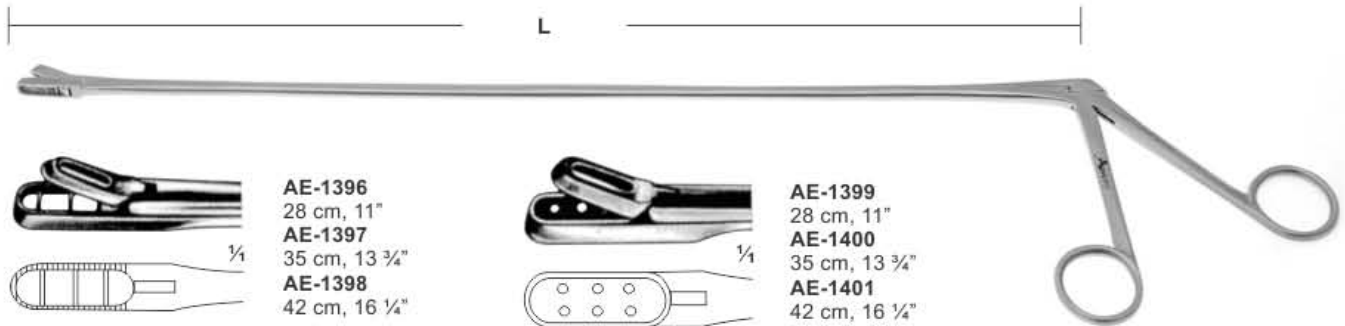

AE-1396
28 cm, 11"
AE-1397
35 cm, 13 3/4"
AE-1398
42 cm, 16 1/4"

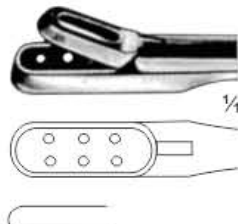

AE-1399
28 cm, 11"
AE-1400
35 cm, 13 3/4"
AE-1401
42 cm, 16 1/4"

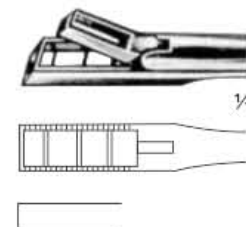

AE-1402
28 cm, 11"
AE-1403
35 cm, 13 3/4"
AE-1404
42 cm, 16 1/4"

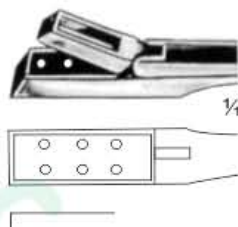

AE-1405
28 cm, 11"
AE-1406
35 cm, 13 3/4"
AE-1407
42 cm, 16 1/4"

YEOMANN

PILE FORCEPS

COTTON CARRIER

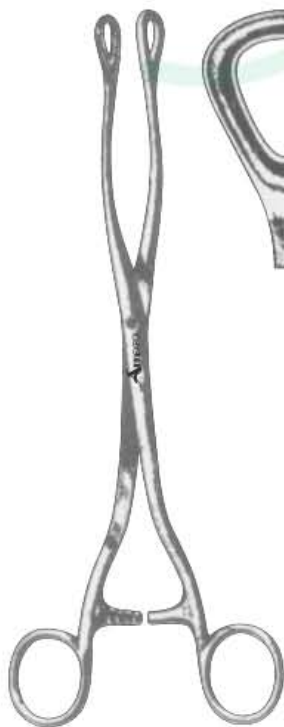

LURE
AE-1408 24.5cm



JARVIS
AE-1409 23cm



LANGENBECK
AE-1410 45cm



AE-1411 45cm

VAGINAL SPECULA

Vaginalspekula
Especulos vaginales

Spéculums vaginaux
Specoli vaginali



CUSCO
AE-1412 75 x 32 mm
AE-1413 85 x 35 mm
AE-1414 100 x 35 mm



CUSCO
AE-1415 90 x 22 mm
AE-1416 100 x 25 mm
AE-1417 105 x 27 mm

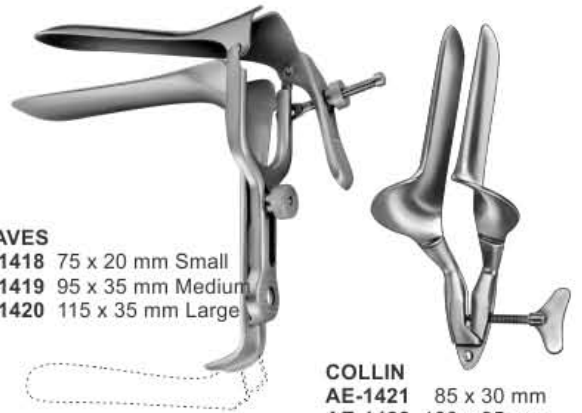

GRAVES
AE-1418 75 x 20 mm Small
AE-1419 95 x 35 mm Medium
AE-1420 115 x 35 mm Large

COLLIN
AE-1421 85 x 30 mm
AE-1422 100 x 35 mm
AE-1423 110 x 40 mm



COLLIN
AE-1424
55 x 10 mm



WINTERTON
AE-1425



PEDERSON
AE-1426
75 x 13 mm Small
AE-1427
100 x 22 mm Medium
AE-1428
120 x 25 mm Large



Graves Vaginal Speculum Leep / Lietz
AE-1429 Small
AE-1430 Medium
AE-1431 Large
AE-1432 X-large



Pederson Vaginal Speculum Leep / Lietz
AE-1433 Small
AE-1434 Medium
AE-1435 Large
AE-1436 X-Large



CUSCO
AE-1437 Small
AE-1438 Medium
AE-1439 Large



SAKURAS
AE-1440 Small
AE-1441 Medium
AE-1442 Large

VAGINAL SPECULA



Vaginalspekula
Especulos vaginales

Spéculums vaginaux
Specoli vaginali



KRISTELLER
AE-1443 110x18 mm
AE-1444 110x20 mm
AE-1445 110x27 mm
AE-1446 110x30 mm
AE-1447 110x36 mm
22 cm



Slightly Concave

AE-1448
80 x 28 mm

AE-1449
85 x 35 mm

AE-1450
85 x 40 mm

KRISTELLER
20.5 cm, 8"



Slightly Concave

AE-1451
76 x 38 mm

AE-1452
89 x 38 mm

AE-1453
102 x 38 mm

JACKSON
17.5 cm, 7"



DOYEN
23.5 cm, 9 1/4"

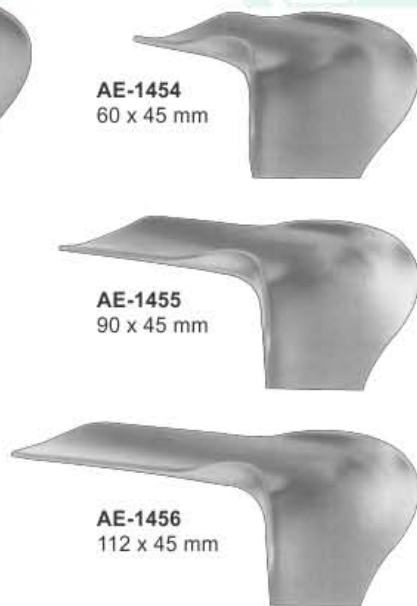

AE-1454
60 x 45 mm

AE-1455
90 x 45 mm

AE-1456
112 x 45 mm



SIMS-KELLY
AE-1457 57 x 25 mm
AE-1458 69 x 45 mm
AE-1459 76 x 38 mm
24 cm, 9 1/2"



SIMS
AE-1460 Small
AE-1461 Medium
AE-1462 Large



PRATT GYNE
AE-1463
Set of 8 Double ended
size 13/14 thru 41/43
4.5/5.0mm thru 13.6/14.3mm



AE-1464 Set of 14 dilators
(4.0 - 17.0 mm), in leather pouch
with removable, washable canvas
lining, with zip fastener

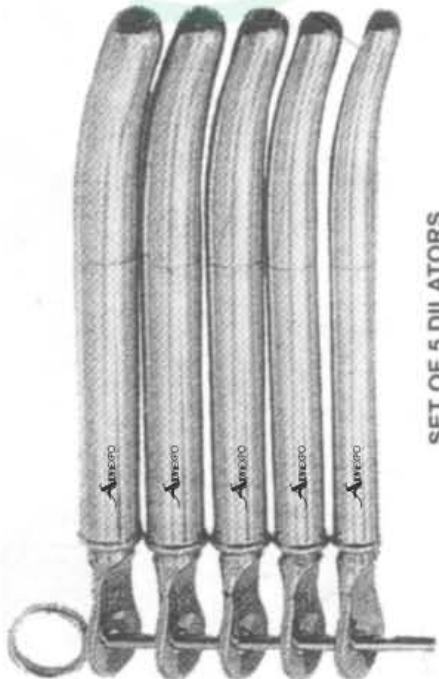

SET OF 5 DILATORS

DILATORS SET
AE-1465
Set of 5 dilators



Hank with conical point double ended

Fig.	mmØ	Hank
9/10	4.5/5	AE-1466
11/12	5.56	AE-1467
13/14	6.5/7	AE-1468
15/16	7.5/8	AE-1469
17/18	8.5/9	AE-1470
19/20	9.5/10	AE-1471

OBSTETRICAL FORCEPS

Geburtszangen
Forceps obstétricos

Forceps obstétriques
Forcipi obstetrici



KIELLAND
AE-1472
41 cm, 16"



SIMPSON
AE-1473
30 cm, 12"



SIMPSON-BRAUN
AE-1474 33 cm, 13 ½"
AE-1475 38 cm, 14 ½"



DE LEE
AE-1476
30 cm, 12"



WRIGLEY
AE-1477
23 cm, 9"



DE LEE
AE-1478
30cm 12"



DE LEE
AE-1479
36cm 14"



ELLIOT
AE-1480 32cm
AE-1481 38cm



KIELLAND-LUIKART
AE-1482
41 cm, 16"



NAEGELE
AE-1483 36 cm, 14 ¼"
AE-1484 40 cm, 15 ¾"



PIPER
AE-1485
44 cm, 18"



STERILIZING DRUMS

	Ø	h
	mm	mm
AE-1486	80	80
AE-1487	120	120
AE-1488	160	120
AE-1489	190	140
AE-1490	190	200
AE-1491	240	120
AE-1492	240	160
AE-1493	240	240
AE-1494	290	120
AE-1495	290	160
AE-1496	290	240
AE-1497	340	160
AE-1498	340	240
AE-1499	390	145
AE-1500	390	200
AE-1501	390	290



STERILIZING DRUM

	Ø	h
	mm	Size mm
AE-1502	150	150
AE-1503	175	175
AE-1504	190	190
AE-1505	200	140
AE-1506	200	200
AE-1507	240	120
AE-1508	225	225
AE-1509	240	240
AE-1510	290	160
AE-1511	280	240
AE-1512	230	150
AE-1513	300	250
AE-1514	340	250
AE-1515	350	250
AE-1516	390	200



STERILIZING DRUM

	Ø	h
	mm	Size mm
AE-1517	150	150
AE-1518	175	175
AE-1519	190	190
AE-1520	200	140
AE-1521	200	200
AE-1522	240	120
AE-1523	225	225
AE-1524	240	240
AE-1525	290	160
AE-1526	280	240
AE-1527	230	150
AE-1528	300	250
AE-1529	340	250
AE-1530	350	250
AE-1531	390	200



STERILIZING DRUM

	Ø	h
	mm	Size mm
AE-1532	150	150
AE-1533	175	175
AE-1534	190	190
AE-1535	200	140
AE-1536	200	200
AE-1537	240	120
AE-1538	225	225
AE-1539	240	240
AE-1540	290	160
AE-1541	280	240
AE-1542	230	150
AE-1543	300	250
AE-1544	340	250
AE-1545	350	250
AE-1546	390	200



STERILIZING DRUM

	Ø	h
	mm	Size mm
AE-1547	150	150
AE-1548	175	175
AE-1549	190	190
AE-1550	200	140
AE-1551	200	200
AE-1552	240	120
AE-1553	225	225
AE-1554	240	240
AE-1555	290	160
AE-1556	280	240
AE-1557	230	150
AE-1558	300	250
AE-1559	340	250
AE-1560	350	250
AE-1561	390	200

HOLLOW WARES



G LOVES BOX
AE-1562
300 x 150 mm



INSTRUMENT TRAY WITH COVER
AE-1563



INSTRUMENT TRAY
AE-1564



CATHETER TRAY

- Size
- AE-1565 230 x 75 mm
 - AE-1566 350 x 90 mm
 - AE-1567 430 x 100 mm
 - AE-1568 200 x 100 mm
 - AE-1569 300 x 100 mm
 - AE-1570 350 x 100 mm



INSTRUMENT BOILER

- Size
- AE-1571 180 x 80 x 40 mm
 - AE-1572 200 x 100 x 50 mm
 - AE-1573 250 x 125 x 40 mm
 - AE-1574 300 x 150 x 60 mm
 - AE-1575 350 x 175 x 75 mm
 - AE-1576 400 x 200 x 100 mm



PERFORATED TRAY

- Size
- AE-1577 180 x 80 x 40 mm
 - AE-1578 200 x 100 x 50 mm
 - AE-1579 250 x 125 x 40 mm
 - AE-1580 300 x 150 x 60 mm
 - AE-1581 350 x 175 x 75 mm
 - AE-1582 400 x 200 x 100 mm



INSTRUMENT BOILER WITH STAND

- Size
- AE-1583 180 x 80 x 40 mm
 - AE-1584 200 x 100 x 50 mm
 - AE-1585 250 x 125 x 40 mm
 - AE-1586 300 x 150 x 60 mm
 - AE-1587 350 x 175 x 75 mm
 - AE-1588 400 x 200 x 100 mm



INSTRUMENT BOILER ELECTRIC

- Size
- AE-1589 180 x 80 x 40 mm
 - AE-1590 200 x 100 x 50 mm
 - AE-1591 250 x 125 x 40 mm
 - AE-1592 300 x 150 x 60 mm
 - AE-1593 350 x 175 x 75 mm
 - AE-1594 400 x 200 x 100 mm



PERFORATED BOX

- Size
- AE-1595 100 x 50 mm
 - AE-1596 165 x 65 mm
 - AE-1597 250 x 100 mm
 - AE-1598 250 x 150 mm
 - AE-1599 250 x 200 mm
 - AE-1600 150 x 65 mm
 - AE-1601 170 x 70 mm
 - AE-1602 200 x 100 mm
 - AE-1603 250 x 125 mm
 - AE-1604 300 x 150 mm
 - AE-1605 300 x 200 mm
 - AE-1606 300 x 130 mm
 - AE-1607 320 x 150 mm
 - AE-1608 420 x 180 mm
 - AE-1609 460 x 125 mm
 - AE-1610 355 x 180 mm
 - AE-1611 300 x 180 mm
 - AE-1612 400 x 200 mm
 - AE-1613 510 x 200 mm



BOX WITH FILTER

- Size
- AE-1614 100 x 50 mm
 - AE-1615 165 x 65 mm
 - AE-1616 250 x 100 mm
 - AE-1617 250 x 150 mm
 - AE-1618 250 x 200 mm
 - AE-1619 150 x 65 mm
 - AE-1620 170 x 70 mm
 - AE-1621 200 x 100 mm
 - AE-1622 250 x 125 mm
 - AE-1623 300 x 150 mm
 - AE-1624 300 x 200 mm
 - AE-1625 300 x 130 mm
 - AE-1626 320 x 150 mm
 - AE-1627 420 x 180 mm
 - AE-1628 460 x 125 mm
 - AE-1629 355 x 180 mm
 - AE-1630 300 x 180 mm
 - AE-1631 400 x 200 mm
 - AE-1632 510 x 200 mm



INSTRUMENTS BOX

- Without Clip Size
- AE-1633 100 x 50 mm
 - AE-1634 165 x 65 mm
 - AE-1635 250 x 100 mm
 - AE-1636 250 x 150 mm
 - AE-1637 250 x 200 mm
 - AE-1638 150 x 65 mm
 - AE-1639 170 x 70 mm
 - AE-1640 200 x 100 mm
 - AE-1641 250 x 125 mm
 - AE-1642 300 x 150 mm
 - AE-1643 300 x 200 mm
 - AE-1644 300 x 130 mm
 - AE-1645 320 x 150 mm
 - AE-1646 420 x 180 mm
 - AE-1647 460 x 125 mm
 - AE-1648 355 x 180 mm
 - AE-1649 300 x 180 mm
 - AE-1650 400 x 200 mm
 - AE-1651 510 x 200 mm



INSTRUMENT BOX

- With Clip Size
- AE-1652 100 x 50 mm
 - AE-1653 165 x 65 mm
 - AE-1654 250 x 100 mm
 - AE-1655 250 x 150 mm
 - AE-1656 250 x 200 mm
 - AE-1657 150 x 65 mm
 - AE-1658 170 x 70 mm
 - AE-1659 200 x 100 mm
 - AE-1660 250 x 125 mm
 - AE-1661 300 x 150 mm
 - AE-1662 300 x 200 mm
 - AE-1663 300 x 130 mm
 - AE-1664 320 x 150 mm
 - AE-1665 420 x 180 mm
 - AE-1666 460 x 125 mm
 - AE-1667 355 x 180 mm
 - AE-1668 300 x 180 mm
 - AE-1669 400 x 200 mm
 - AE-1670 510 x 200 mm



KIDNEY TRAY WITH COVER
(English Pattern)

	Size
AE-1671	150 mm
AE-1672	200 mm
AE-1673	240 mm
AE-1674	300 mm



KIDNEY TRAY (German Pattern)
(without cover)

	Size
AE-1675	150 mm
AE-1676	200 mm
AE-1677	240 mm
AE-1678	300 mm



SPLIT LAMP
AE-1679
100 ml.



BOWL

	Size
AE-1680	80 mm
AE-1681	100 mm
AE-1682	125 mm
AE-1683	150 mm
AE-1684	200 mm
AE-1685	250 mm
AE-1686	300 mm
AE-1687	350 mm
AE-1688	400 mm



WASH BASIN

	Size
AE-1689	80 mm
AE-1690	100 mm
AE-1691	125 mm
AE-1692	150 mm
AE-1693	200 mm
AE-1694	250 mm
AE-1695	300 mm
AE-1696	350 mm
AE-1697	400 mm



BOWL

	Size
AE-1698	80 mm
AE-1699	100 mm
AE-1700	125 mm
AE-1701	150 mm
AE-1702	200 mm
AE-1703	250 mm
AE-1704	300 mm
AE-1705	350 mm
AE-1706	400 mm



DRESSING JAR WITH KNOB

	Size
AE-1707	80 x 80 mm
AE-1708	100 x 100 mm
AE-1709	125 x 125 mm
AE-1710	150 x 150 mm
AE-1711	200 x 200 mm



DRESSING JAR

	Size
AE-1712	80 x 80 mm
AE-1713	100 x 100 mm
AE-1714	125 x 125 mm
AE-1715	150 x 150 mm
AE-1716	200 x 200 mm



DRESSING JAR

	Size
AE-1717	80 x 80 mm
AE-1718	100 x 100 mm
AE-1719	125 x 125 mm
AE-1720	150 x 150 mm
AE-1721	200 x 200 mm



DRESSING JAR

	Size
AE-1722	80 x 80 mm
AE-1723	100 x 100 mm
AE-1724	125 x 125 mm
AE-1725	150 x 150 mm
AE-1726	200 x 200 mm

Micro Forceps



Chalazion Clamp
AE-1727
11cm



Chalazion Forceps
AE-1728
Oval 12 X 14mm, 10 cm long



AE-1729
Round 8mm,
10 cm long



AE-1730
Round 15mm,
10 cm long



AE-1731
Oval 17 X 9mm,
10 cm long



Chalazion Forceps
AE-1732



Cauer
AE-1733
10 cm
Chalazion Forceps



Suture Tying Forceps
AE-1734 9cm
AE-1735 11cm



McPherson Forceps
AE-1736 9cm
AE-1737 11cm



Corneal Forceps
1x2 (0.12)
AE-1738 9cm
AE-1739 11cm



Bonn Forceps
AE-1740
11cm



Utrata
Capsulorhexis
Forceps
AE-1741 11cm
Curved



Utrata
Capsulorhexis
Forceps
AE-1742 11cm
Straight



Colibri Forceps
1x2 (0.12)
AE-1743



Holding & Folding
Forceps
for Acrylic Lenses
AE-1744
11cm



Holding & Folding
Forceps
for Acrylic Lenses
AE-1745
11cm



Morefeld Forceps
AE-1746
11cm

EYE FORCEPS

Round Handle Available



Suture Tying Forceps
AE-1747 9cm
AE-1748 11cm

Round Handle Available



McPherson Forceps
AE-1749 9cm
AE-1750 11cm



Corneal Forceps
1x2 (0.12)
AE-1751 9cm
AE-1752 11cm



Bonn Forceps
AE-1753 9cm
AE-1754 11cm



Utrata Capsulorhexis Forceps
AE-1755 9cm
AE-1756 11cm
Curved



Utrata Capsulorhexis Forceps
AE-1757 9cm
AE-1758 11cm
Straight



Holding & Folding Forceps
for Acrylic Lenses
AE-1759 9cm
AE-1760 11cm



Holding & Folding Forceps
for Acrylic Lenses
AE-1761 9cm
AE-1762 11cm



Colibri Forceps
with tying platform
AE-1763

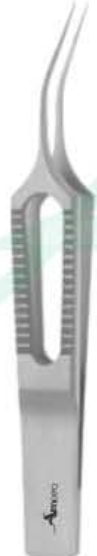

Gerl
Tying Forceps
curved shanks
6mm long platform
For 8-0 to 11-0 sutures.
titanium
AE-1764



Tennant
Tying Forceps
extra delicate smooth jaws
with 6mm long platform
round handle with guide pin
For 9-0 to 11-0 sutures.
AE-1765 straight
AE-1766 straight, titanium
AE-1767 curved
AE-1768 curved, titanium



AE-1769
10 cm
sharp

AE-1770
10 cm
blunt

Self-Retaining
Retractors



Berke
AE-1771
11 cm
Ptosis Forceps



Förster
AE-1772
10 cm
Conjunctiva
Forceps



Fechtner Conjunctiva
Forceps
AE-1773 11 cm long
Very delicate ring tips,
with tying
platforms



Scleral Plug Forceps
AE-1774
Designed to securely
hold scleral plugs during
insertion and removal.
The cross-action handle
reduces hand fatigue
while grasping plug,
11.5 cm long

FORCEPS

Botvin Iris Forceps
AE-1775 serrated tips
AE-1776 1x2 teeth



Gills-Colibri
 Tissue Forceps
 very fine pointed tips
 with tying platform
AE-1777



Colibri Tissue Forceps
AE-1778 1x2 teeth, 0.12mm with tying platform
AE-1779 1x2 teeth, 0.30mm with tying platform
AE-1780 1x2 teeth, 0.40mm with tying platform



Colibri Style Tissue Forceps
AE-1781 Harms-Colibri, with tying platform
AE-1782 Dyson-Colibri, short tips, extremely thin shanks, with tying platform Standard, 1x2 teeth with tying platform
AE-1783 Polack Corneal Forceps very delicate, 1x1 teeth, 0.1mm
AE-1784 Pierse-Colibri



AE-1781



AE-1782



AE-1783



AE-1784

Colibri Style Tissue Forceps, titanium
AE-1785T Harms-Colibri, with tying platform
AE-1786T Dyson-Colibri, short tips, extremely thin shanks, with tying platform Standard, 1x2 teeth with tying platform
AE-1787T Polack Corneal Forceps very delicate, 1x1 teeth, 0.1mm
AE-1788T Pierse-Colibri

Hoskin Tissue Forceps, straight
AE-1789 0.1mm very delicate, micro grooved tips
AE-1790 0.2mm micro grooved tips
AE-1791 0.3mm fine grooved tips
AE-1792 0.4mm fine grooved tips



AE-1789
AE-1790

AE-1791

AE-1792

Hoskin Tissue Forceps, straight Titanium
AE-1793T 0.1mm very delicate, micro grooved tips
AE-1794T 0.2mm micro grooved tips
AE-1795T 0.3mm fine grooved tips
AE-1796T 0.4mm fine grooved tips



Helveston Fixation Forceps
1x2 teeth, 0.6mm
AE-1793



McPherson Tissue Forceps
1x2 teeth,
with tying platform
AE-1794 0.3mm straight
AE-1795 0.3mm angled
AE-1796 0.4mm straight
AE-1797 0.4mm angled



Kelman-McPherson Forceps
8mm long jaws with tying platform 1x2 teeth
AE-1798 0.3mm
AE-1799 0.4mm
AE-1800T 0.3mm titanium
AE-1801T 0.4mm titanium



Girard Corneoscleral Forceps
1x2 teeth, 0.12mm
with tying platform
AE-1802 for use in left hand
AE-1803 for use in right hand



Perl Corneal Forceps
1x2, 0.08mm teeth
AE-1804 for use in left hand
AE-1805 for use in right hand



Maumenee-Colibri Corneal Forceps
very delicate
1x2 teeth, 0.12mm
AE-1806



FORCEPS

Bishop-Harmon Tissue Forceps
1x2 teeth
AE-1807 0.12mm delicate
AE-1808 0.30mm standard

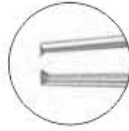

Bishop-Harmon Dressing Forceps
cross serrated tips
AE-1809

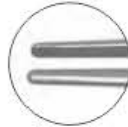

Fixation Forceps
1x2 teeth, 0.3mm
AE-1810 Sauer
AE-1811 Manhattan
with tying platform



Lester Fixation Forceps
straight
AE-1812 1x2 teeth
AE-1813 2x3 teeth



AE-1814
Fixation Forceps 1x2 teeth
Bracken, delicate teeth



AE-1815
Troutman Superior Rectus Forceps
1x2 teeth angled



Jayle Corneal Tying Forceps
AE-1816
0.15mm teeth
AE-1817
0.3mm teeth



St. Martin Corneal Tying Forceps
AE-1818
0.15mm teeth
AE-1819
0.3mm teeth



Tying Forceps For 8-0 to 10-0 sutures.

McPherson smooth jaws

- AE-1820 straight 5mm
- AE-1821 straight 8mm
- AE-1822 straight 10mm
- AE-1823 angled 5mm



McPherson smooth jaws titanium

- AE-1824T straight 5mm
- AE-1825T straight 8mm
- AE-1826T straight 10mm
- AE-1827T angled 5mm

Kelman-McPherson smooth jaws

- AE-1828 angled 8mm
- AE-1829 angled 10mm

Kelman-McPherson smooth jaws titanium

- AE-1830T angled 8mm
- AE-1831T angled 10mm

Tying Forceps

For 8-0 to 11-0 sutures.

AE-1832 angled

Bechert 10mm long smooth jaws

AE-1833 angled

Gaskin 11mm long smooth jaws



Haberle-McPherson

Lens Holding Forceps

7.5mm long jaws
with groove, angled

AE-1834



Kurstin

Flap Stretching Forceps

disc shaped
serrated jaws

AE-1835



Buratto

LASIK Flap Forceps

disc shaped
serrated jaws

AE-1836



Mendez

Multi-Purpose

LASIK Forceps

spatulated jaws and tips
smooth grasping surfaces
vaulted shanks

AE-1837



TIP CROSSSECTION



Inamura

Capsulorrhexis Forceps

delicate tapered shanks

AE-1838



Micro Scissors



AE-1839
Cooley
18 cm



AE-1840
Castroviejo TC
18cm



AE-1841
Noyes Micro Scissors
CVD 18cm



IOL Holding Forceps
AE-1842 11.5cm



Micro Needle Holders
AE-1843 11.5cm



Corneal Scissors
AE-1844 11.5cm



Cepsulotomy Scissors
AE-1845 11.5cm



Vannas Scissors
AE-1846 11.5cm
Straight



Vannas Scissors
AE-1847 11.5cm
Curved



Westcott Scissors
AE-1848 11.5cm



Iris Scissors
AE-1849 11.5cm

**Castroviejo
Corneoscleral Scissors**
small blades
AE-1850 left
AE-1851 right



**Castroviejo
Corneoscleral Scissors**
medium blades
AE-1852 left
AE-1853 right



**Troutman-Castroviejo
Corneoscleral Scissors**
with stop, small blades
AE-1854 left
AE-1855 right



**Troutman-Castroviejo
Corneoscleral Scissors**
with stop, medium blades
AE-1856 left
AE-1857 right



**Troutman-Katzin
Corneal Transplant Scissors**
with stop
strong curve, small blades
AE-1858 left
AE-1859 right



**Rich Corneal
Transplant Scissors**
extremely delicate,
strongly curved blades
AE-1860 left
AE-1861 right



Katzin Corneal Transplant Scissors
strong curve, medium blades
AE-1862 left
AE-1863 right





AE-1867

AE-1868

AE-1869



AE-1870

AE-1871

AE-1872



AE-1873

**Vannas Scissors
AE-1864**

Sharp pointed tips. Curved 7.5mm blades, 9.5mm from pivot to tip, 8 cm long

**Vannas Scissors
AE-1865**

Sharp tips. Angled to side 7mm blades, 9mm from pivot to tip, 8 cm long

AE-1866

Capsulotomy Scissors Vannas

5mm long blades, sharp tips

AE-1866 straight

AE-1867 curved

AE-1868 angled forward

AE-1869 angled to side

Gills-Vannas

7mm long blades, sharp tips

AE-1870 straight

AE-1871 curved

AE-1872 angled forward

McPherson-Vannas

8mm long blades, sharp tips

AE-1873 curved



Barraquer

Needle Holder

delicate jaws, curved

AE-1874 with lock

AE-1875 without lock

McPherson

Needle Holder

very delicate jaws

AE-1876 with lock straight

AE-1877 without lock straight

AE-1878 with lock curved

AE-1879 without lock curved

Micro Needle Holder

Needle Holder

delicate jaws

strongly curved

AE-1880 with lock

AE-1881 without lock

Castroviejo

Needle Holder

delicate jaws, curved

AE-1882 with lock

AE-1883 without lock

Castroviejo

Needle Holder

standard jaws

straight, with lock

AE-1884

AE-1885 TC Tungsten Tip

Kalt

Needle Holder

delicate smooth jaws

straight, with lock

AE-1886



Micro Incision Forceps
AE-1887



Micro Incision Scissors
AE-1888



Endothelial Grasping Forceps
AE-1888
curved, 23 gauge
delicate end-gripping
platforms jaws 90°
off-set from "squeeze handle"
mechanism



Vitreoretinal Forceps
AE-1890
Lens Cartridge
Loading Forceps
straight, 20 gauge



Scissors
horizontal opening
straight
AE-1891



Scissors
horizontal opening
angled 60°
AE-1893



Scissors
horizontal opening
angled 30°
AE-1892



Scissors
horizontal opening
angled 80°
AE-1894

Vitreotomy Scissors
T20 gauge shank
Stainless steel
construction with
flat handle.
Autoclavable.



Troutman-Castroviejo
delicate patterns, with stop



AE-1895
10,5 cm
right



AE-1896
10,5 cm
left



Wecker
AE-1897
11 cm
pointed-pointed

11 mm

CURETTE, HOOK & PROBES



Curette
AE-1898



Wire Vectus
AE-1899



Strabismus Hook
AE-1900



Lense Expressor
AE-1901



Bimanual Hand Irrigation
AE-1902



Bimanual Hand Aspiration
AE-1903



Sinskey
Hook
AE-1904



Nagahara
Chopper
AE-1905



Lachrymal Dilator
Double Ended
AE-1906



Lachrymal Dilator
AE-1907 Fine Taper
AE-1908 Medium Taper
AE-1909 Heavy Taper



Lachrymal Probes
AE-1910

Swiss Model

Blade Breaker and Holder
spherical tip
AE-1911



Wills Eye Hospital

Foreign Body Spud & Burr
delicate curved spud on one
end and small burr for rust
ring removal on opposite end
AE-1912



Spud & Gouge
AE-1913



Foreign Body Spud

AE-1914 Ellis, lightly curved and rounded tip
AE-1915 Francis, angled, flag shaped tip
AE-1916 Golf Club, angled, lightly rounded tip



AE-1914

AE-1915

AE-1916



Fukasaku

"Hockey" Knife
sharp 3mm front edge
semi-sharp 6mm bottom edge
AE-1917



Gill

Corneal Knife
curved cutting edge
AE-1918 straight
AE-1919 light curve



Tooke

Corneal Knife
straight blade
with curved cutting edge
AE-1920



Corneal Dissector

AE-1921 angled, straight blade
AE-1922 angled, curved blade



AE-1921

AE-1922



Meyerhoefer Chalazion Curette

AE-1923 size 0, 1.5mm dia.
AE-1924 size 1, 1.75mm dia.
AE-1925 size 2, 2.25mm dia.
AE-1926 size 3, 2.5mm dia.
AE-1927 size 4, 3.5mm dia.



Capsule Polishing Curette

1.75mm diameter open ring
AE-1928 Nightingale, semi-sharp,
 posterior edge
AE-1929 Shepherd, semi-sharp
 anterior and posterior edges



Scorsetti-Shepherd

Capsule Polisher
AE-1930
 1.75mm diameter open ring
 tip angled 90°
 semi-sharp
 anterior and posterior edges



Buratto

LASIK Flap Protector
AE-1931



Mannis-Buratto

LASIK Flap Protector
 blades angled 45°
AE-1932



Stevens

Tenotomy Hook
 blunt, small
AE-1933



Helveston

"Teaser" Hook
 extra delicate, blunt
AE-1934



MUSCLE HOOK

Graefe
Muscle Hook
AE-1935 size 1
AE-1936 size 2
AE-1937 size 3



Gass
Retinal Detachment Hook
with oval hole
AE-1938



Arruga
Muscle Hook
AE-1939 left
AE-1940 right
AE-1941 double end



Helveston
Finder Hook
extra delicate with lightly
angled cone shaped tip
AE-1942 small
AE-1943 large



Helveston
Muscle Hook
extra delicate, with blunt
spatulated tip
AE-1944 8mm
AE-1945 10mm
AE-1946 12mm



Jameson
Muscle Hook
AE-1947 small
AE-1948 large



Du Plessis
Muscle Hook
double arm
AE-1949



IOL MANIPULATORS



Sinskey
Lens Manipulating Hook
0.25mm diameter blunt tip
straight
AE-1950



Harris-Sinskey
Lens Manipulating Hook
0.25mm diameter blunt tip
angled
AE-1951



Sinskey II
Lens Manipulating Hook
0.2mm diameter blunt tip
AE-1952 straight
AE-1953 angled



Lens Manipulating Hook
0.15mm diameter blunt tip
AE-1954 Jaffe, straight
AE-1955 Clayman-Jaffe, angled



Nevyas
Soft IOL Manipulator
0.25mm diameter
textured tip
straight, with guard
AE-1956



Sinskey
Lens Manipulating Hook
round handle
0.25mm diameter blunt tip
AE-1957 straight, with guard
AE-1958 angled



Sinskey II
Lens Manipulating Hook
0.2mm diameter blunt tip
round handle
AE-1959 straight, with guard
AE-1960 angled



Lewicky
Lens Manipulating Hook
0.15mm diameter blunt tip
angled, vaulted shank
AE-1961





Sinskeyll
 Lens Manipulating Hook
 0.2mm diameter blunt tip
AE-1962 straight
AE-1963 angled



Lens Manipulating Hook
 0.15mm diameter tip
AE-1964
 Fenzl, round handle
 straight with guard
AE-1965
 Fenzl, round handle, angled
AE-1966
 Maltzman-Fenzl, round handle,
AE-1967
 Maltzman-Fenzl, round handle,
 angled
AE-1968
 Jaffe-Maltzman, flat handle, angled



Fixation Hook
 double, sharp
AE-1969
 15 cm
AE-1970
 18 cm

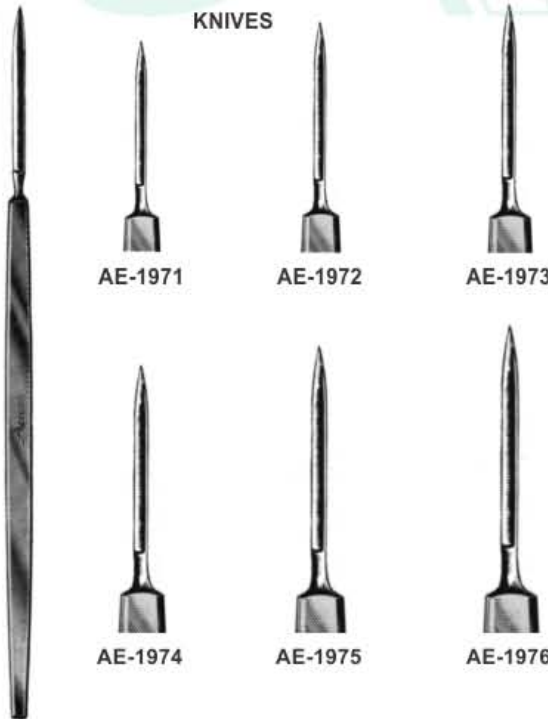

KNIVES

AE-1971

AE-1972

AE-1973

AE-1974

AE-1975

AE-1976

VON GRAEFE Knife
 Graefe
 1,2,3,4,5,



Jaeger Lid Plate
AE-1977
 Jaeger
 4",20mm,23mm,

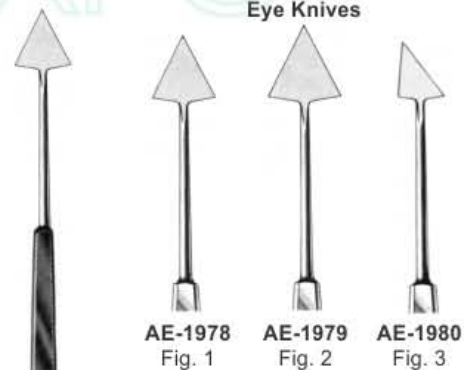

Eye Knives

AE-1978
 Fig. 1

AE-1979
 Fig. 2

AE-1980
 Fig. 3

Jaegar

Barraquer Wire Speculum

AE-1981 infant size, 9mm blades

AE-1982 standard wire, 10mm blades

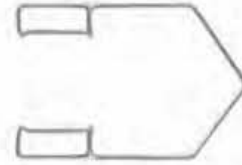

Barraquer Wire Speculum

AE-1983 standard wire, 15mm blades

AE-1984 heavy wire, 15mm blades

AE-1985 extra heavy wire, 15mm blades

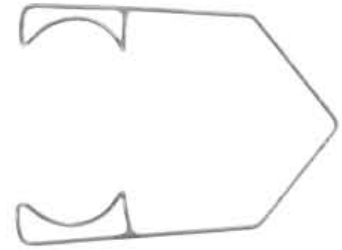

Kratz-Barraquer Wire Speculum

with open blades

AE-1986 standard wire, 13mm blades

AE-1987 standard wire, 15mm blades

AE-1988 heavy wire, 15mm blades



Kratz-Barraquer

Wire Speculum

with wings

AE-1989 15mm blades

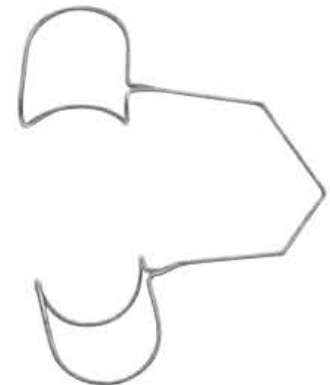

Grandon-Barraquer

Wire Speculum

with suture notches

AE-1990 15mm blades

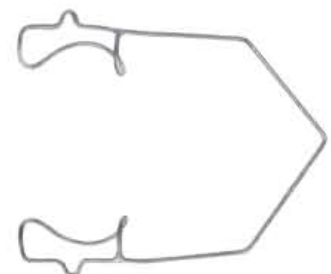

Kratz-Barraquer Wire Speculum
 15mm blades
 one solid and one open wire
AE-1991 for left eye
AE-1992 for right eye

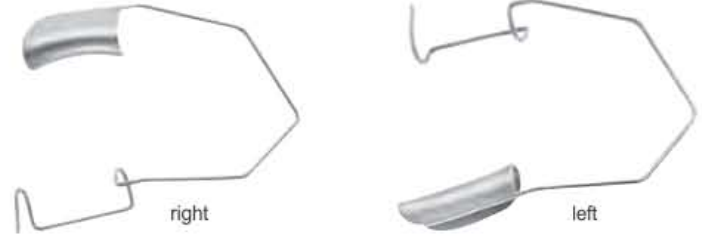

Temporal Approach
 Wire Speculum
 with spring on nasal side
AE-1993 15mm solid blades
AE-1994 15mm open blades
AE-1995 15mm closed blades

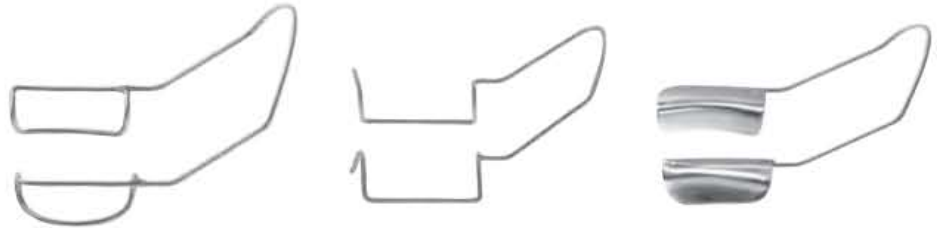

McIntyre Wire Speculum
 gently curved springs
AE-1996 open wire, 13mm blades
AE-1997 closed wire, 13mm blades

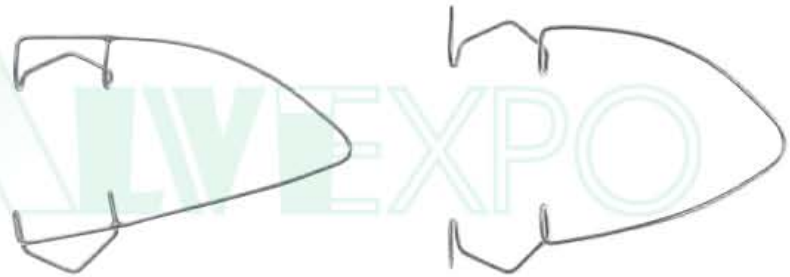

Nevyas Wire Speculum
AE-1998 16mm blades

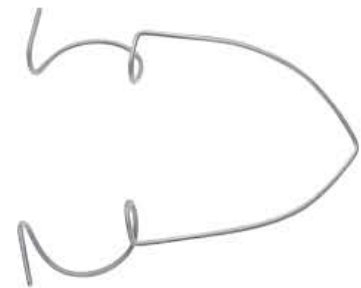

Solid Blade Wire Speculum
AE-1999 Barraquer, 10mm blades
AE-2000 Barraquer, 15mm blades
AE-2001 Feaster, 20mm blades



SPECULUMS & CALIPERS



**Barraquer Wire Speculums
AE-2002**
heavy wire, 15mm blades



**Barraquer Solid Blade
Wire Speculum
AE-2003**
Barraquer, 10mm blades



**Kratz - Barraquer
Wire Speculum
15mm blades**
one solid and one open wire
AE-2004
for right eye



**Kratz - Barraquer
Wire Speculum
15mm blades**
one solid and one open wire
AE-2005
left eye



Wire
Speculums
AE-2006

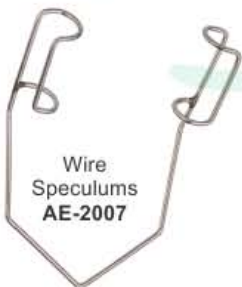

Wire
Speculums
AE-2007



Laster-Burch Speculum
eye Speculum with flanges on
blades for retaining eye lashes
adjustable mechanism
with locking screw
AE-2008
11mm blades



Lieberman
Speculum
AE-2009



Clark
Speculums
AE-2010



**Jameson
Caliper** chrome
plated
AE-2011



Braunstein Caliper
3.5/4.0mm
Stainless Steel
AE-2012



AE-2013
Calliper
Fixed



Fixed
Caliper
AE-2014



Castroviejo Caliper
20mm spread
AE-2015 straight
AE-2016 angled
AE-2017 curved

Mellinger
Eye Speculum
self retaining
AE-2018 15mm blades



Clark Speculums
with locking screw
blade 15mm
AE-2019



Williams
Eye Speculum
with locking screw
AE-2020 11mm blades
AE-2021 15mm blades



Lancaster
Eye Speculum
adjustable mechanism
with locking nut
AE-2022 16mm blades



Lester-Burch
Eye Speculum
with flanges on blades
adjustable mechanism
with locking screw
AE-2023



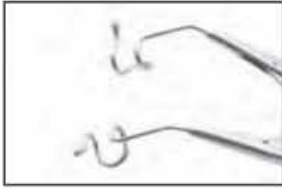

AE-2024
Lieberman, infant K-wire,
5mm

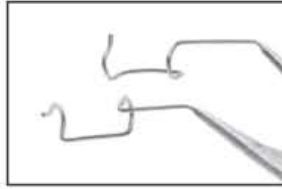

AE-2025
Lieberman, K-wire,
10mm blades, small



AE-2026
Lieberman, K-wire,
15mm blades, standard



AE-2027
Lieberman, infant solid
blade, 5mm



AE-2028
Lieberman, solid blades,
10mm blades
AE-2029
Lieberman, solid blades,
15mm blades

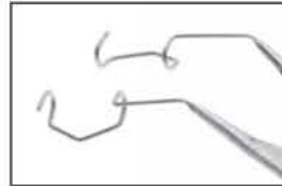

AE-2030
Lieberman, V-shaped,
15mm blades

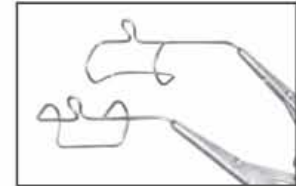

AE-2031
Tanna-Lieberman, 15mm blades
with traction suture anchor posts

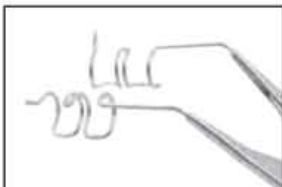

AE-2032
Lieberman, triple post,
13mm blades



AE-2033
Seltzer, flattened K-wire,
15mm blades

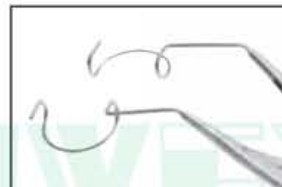

AE-2034
Thorlakson, rounded,
11mm blades



AE-2035
Ginsberg, flared upper blades,
fenestrated lower
blades, 15mm blades

Lieberman Style,
aspirating adjustable mechanism
Supplied with silicone tubing and
luer-lock adaptor.



AE-2036
Lieberman, Kratz style,
15mm blades

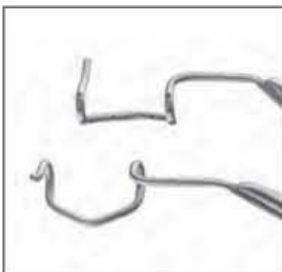

AE-2037
Lieberman, V-shaped,
15mm blades

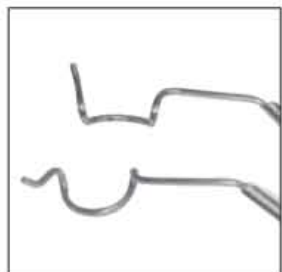

AE-2038
Thorlakson, rounded,
11mm blades



AE-2039
Chu, solid, reversible,
15mm blades

AE-2040
replacement silicone tubing,
100cm

Cannulas



AE-2041



AE-2042



AE-2043



AE-2044



AE-2045



AE-2046



AE-2047

Sterilizing Boxes (with silicon Pads)



AE-2048
50x177mm



AE-2049
Small
90x177mm



AE-2050
Large
152x254mm



AE-2051
50x152mm



AE-2052
Medium
108x254mm



AE-2053

EYE FORCEPS TITANIUM COATED

Round Handle Available



McPherson
Forceps
AE-2054



AE-2055



Suture Tying
Forceps
AE-2056



AE-2057



Utrata Capsulorhexis
Forceps
AE-2058



AE-2059



Corneal Forceps
1x2 (0.12)
AE-2060



AE-2061



Colibri Forceps
extra delicate
1x2 teeth, 0.12mm
with tying platform
AE-2062



Jayle Corneal Tying
Forceps, titanium
AE-2063T
0.15mm teeth
AE-2064T
0.3mm teeth



St. Martin Corneal Tying
Forceps, titanium
AE-2065-15T
0.15mm teeth
AE-2066-30T
0.3mm teeth



Needle Holder
delicate, curved, without lock,
overall length: 115mm, titanium
Ideal for 9-0 to 10-0 sutures
AE-2067 with lock
AE-2068 without lock
AE-2069 titanium, with lock
AE-2070 titanium, without lock



Barraquer Needle Holder
delicate jaws, straight
AE-2071 with lock
AE-2072 without lock
AE-2073 titanium, with lock
AE-2074 titanium, without lock



Nagahara
Chopper
AE-2075



Sinskey
Hook
AE-2076



Rosen
Phco Splitter
60° angled wedge
shaped inferior edge
with blunt tip
AE-2077
Titanium



Maloney
Intra-Operative
Keratometer titanium
For qualitative
measurement
of astigmatism.
AE-2078



Bayonet Bipolar Forceps
AE-2079 15cm
AE-2080 18cm
AE-2081 20cm

Bayonet Bipolar Forceps
AE-2082 15cm
AE-2083 18cm
AE-2084 20cm

Bayonet Bipolar Forceps
AE-2085 15cm
AE-2086 18cm
AE-2087 20cm

Bipolar-Forceps
AE-2088 15.5cm
AE-2089 18cm
AE-2090 20cm

Bipolar-Forceps
AE-2091 15.5cm
AE-2092 18cm
AE-2093 20cm



Irrigation Bipolar Forcep
AE-2094 17cm
AE-2095 20cm

Irrigation Bipolar Forcep
AE-2096 17cm
AE-2097 20cm

Irrigation Bipolar Forcep
AE-2098 15cm
AE-2099 18cm
AE-2100 20cm

Irrigation Bipolar Forcep
AE-2101 15cm
AE-2102 18cm
AE-2103 20cm

Monopolar-Bipolar-Straight Forceps
AE-2104 17cm
AE-2105 20cm

Bipolar-Forceps
AE-2106 15cm
AE-2107 18cm
AE-2108 20cm

Pointed Bipolar-Forceps
AE-2109 15cm
AE-2110 18cm
AE-2111 20cm





Bipolar-Forceps
AE-2112 11.5cm
AE-2113 13cm



Adson Bipolar-Forceps
AE-2114 13cm
AE-2115 15cm



Insulated Vaginal
 Speculum
AE-2116



Vaginal Retractor
 with Ratchet
AE-2117



Vaginal Wall Retractor
AE-2118



Forceps
AE-2119 6.5"
AE-2120 7.5"
AE-2121 8.5"
AE-2122 9.5"
AE-2123 10.5"



Forceps
AE-2124 6.5"
AE-2125 7.5"
AE-2126 8.5"
AE-2127 9.5"
AE-2128 10.5"



Bipolar Artery sealer forceps
AE-2129 6.5"
AE-2130 7.5"
AE-2131 8.5"
AE-2132 9.5"
AE-2133 10.5"



Bipolar Artery sealer forceps
 Non-Stick **AE-2134** 6.5"
 Non-Stick **AE-2135** 7.5"
 Non-Stick **AE-2136** 8.5"
 Non-Stick **AE-2137** 9.5"
 Non-Stick **AE-2138** 10.5"



Adson Forceps With Cable
AE-2139

Special Ophthalmic Bipolar Forceps – Block Connector Molded Flat Fitting



Reusable	Disposable	Product Description and Length	Tip Sizes
AE-2140R	AE-2140	Special Adson Bipolar Forceps Total Length: 12.10cm	0.50mm
AE-2141R	AE-2141	Special Adson Bipolar Forceps Total Length: 12.10cm	0.70mm
AE-2142R	AE-2142	Special Adson Bipolar Forceps Total Length: 12.10cm	1.00mm
AE-2143R	AE-2143	Special Adson Bipolar Forceps Total Length: 12.10cm	1.50mm
AE-2144R	AE-2144	Special Adson Bipolar Forceps Customize Length	On Demand



Reusable	Disposable	Product Description and Length	Tip Sizes
AE-2145R	AE-2145	Special Adson Bipolar Forceps Total Length: 15.00cm	0.50mm
AE-2146R	AE-2146	Special Adson Bipolar Forceps Total Length: 15.00cm	0.70mm
AE-2147R	AE-2147	Special Adson Bipolar Forceps Total Length: 15.00cm	1.00mm
AE-2148R	AE-2148	Special Adson Bipolar Forceps Total Length: 15.00cm	1.50mm
AE-2149R	AE-2149	Special Adson Bipolar Forceps Customize Length	On Demand

Special Straight Bipolar Forceps – Block Connector Molded Flat Fitting



Reusable	Disposable	Product Description and Length	Tip Sizes
AE-2150R	AE-2150	Total Length: 10.80cm	0.50mm
AE-2151R	AE-2151	Total Length: 10.80cm	1.00mm
AE-2152R	AE-2152	Total Length: 10.80cm	2.00mm
AE-2153R	AE-2153	Special Straight Bipolar Forceps Customize Length	On Demand
AE-2154R	AE-2154	Total Length: 14.00cm	0.50mm
AE-2155R	AE-2155	Total Length: 14.00cm	1.00mm
AE-2156R	AE-2156	Total Length: 14.00cm	2.00mm
AE-2157R	AE-2157	Special Straight Bipolar Forceps Customize Length	On Demand
AE-2158R	AE-2158	Total Length: 16.00cm	0.50mm
AE-2159R	AE-2159	Total Length: 16.00cm	1.00mm
AE-2160R	AE-2160	Total Length: 16.00cm	2.00mm
AE-2161R	AE-2161	Special Straight Bipolar Forceps Customize Length	On Demand

ELECTROSURGERY FORCEPS



Monopolar Mclndoe Forceps – Available in 5 Different Connectors



4.8mm Male Plug



4.0mm Male Plug



4.0mm Female Plug



4.0mm Over Mold



Anatomical Plug



Length: 15.50cm Reusable	AE-2162R	AE-2163R	AE-2164R	AE-2165R	AE-2166R
Length: 15.50cm Disposable	AE-2162	AE-2163	AE-2164	AE-2165	AE-2166
Length: 18.00cm Reusable	AE-2167R	AE-2168R	AE-2169R	AE-2170R	AE-2171R
Length: 18.00cm Disposable	AE-2167	AE-2168	AE-2169	AE-2170	AE-2171
Length: 20.00cm Reusable	AE-2172R	AE-2173R	AE-2174R	AE-2175R	AE-2176R
Length: 20.00cm Disposable	AE-2172	AE-2173	AE-2174	AE-2175	AE-2176
Length: 22.00cm Reusable	AE-2177R	AE-2178R	AE-2179R	AE-2180R	AE-2181R
Length: 22.00cm Disposable	AE-2177	AE-2178	AE-2179	AE-2180	AE-2181
Length: 24.00cm Reusable	AE-2182R	AE-2183R	AE-2184R	AE-2185R	AE-2186R
Length: 24.00cm Disposable	AE-2182	AE-2183	AE-2184	AE-2185	AE-2186

Importance Note: Always mention tip sizes while preparing order for these items

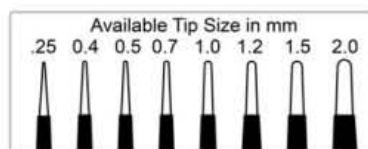

Monopolar Remington Hobb Forceps – Available in 5 Different Connectors



4.8mm Male Plug



4.0mm Male Plug



4.0mm Female Plug



4.0mm Over Mold



Anatomical Plug



Length: 15.50cm Reusable	AE-2187R	AE-2192R	AE-2197R	AE-2202R	AE-2207R
Length: 15.50cm Disposable	AE-2187	AE-2192	AE-2197	AE-2202	AE-2207
Length: 18.00cm Reusable	AE-2188R	AE-2193R	AE-2198R	AE-2203R	AE-2208R
Length: 18.00cm Disposable	AE-2188	AE-2193	AE-2198	AE-2203	AE-2208
Length: 20.00cm Reusable	AE-2189R	AE-2194R	AE-2199R	AE-2204R	AE-2209R
Length: 20.00cm Disposable	AE-2189	AE-2194	AE-2199	AE-2204	AE-2209
Length: 22.00cm Reusable	AE-2190R	AE-2195R	AE-2200R	AE-2205R	AE-2210R
Length: 22.00cm Disposable	AE-2190	AE-2195	AE-2200	AE-2205	AE-2210
Length: 24.00cm Reusable	AE-2191R	AE-2196R	AE-2201R	AE-2206R	AE-2211R
Length: 24.00cm Disposable	AE-2191	AE-2196	AE-2201	AE-2206	AE-2211

Importance Note: Always mention tip sizes while preparing order for these items

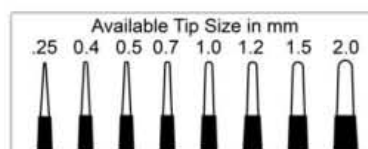

ELECTROSURGERY FORCEPS



Monopolar Dissecting Forceps – Available in 5 Different Connectors



4.8mm Male Plug



4.0mm Male Plug



4.0mm Female Plug



4.0mm Over Mold



Anatomical Plug



Length: 15.50cm Reusable	AE-2212R	AE-2217R	AE-2222R	AE-2227R	AE-2232R
Length: 15.50cm Disposable	AE-2212	AE-2217	AE-2222	AE-2227	AE-2232
Length: 18.00cm Reusable	AE-2213R	AE-2218R	AE-2223R	AE-2228R	AE-2233R
Length: 18.00cm Disposable	AE-2213	AE-2218	AE-2223	AE-2228	AE-2233
Length: 20.00cm Reusable	AE-2214R	AE-2219R	AE-2224R	AE-2229R	AE-2234R
Length: 20.00cm Disposable	AE-2214	AE-2219	AE-2224	AE-2229	AE-2234
Length: 22.00cm Reusable	AE-2215R	AE-2220R	AE-2225R	AE-2230R	AE-2235R
Length: 22.00cm Disposable	AE-2215	AE-2220	AE-2225	AE-2230	AE-2235
Length: 24.00cm Reusable	AE-2216R	AE-2221R	AE-2226R	AE-2231R	AE-2236R
Length: 24.00cm Disposable	AE-2216	AE-2221	AE-2226	AE-2231	AE-2236

Importance Note: Always mention tip sizes while preparing order for these items

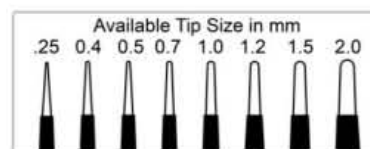

Double Isolated Premium Quality Gynecology – Forceps



Champion Forceps
AE-2237
Size:22.00cm
Length



Ring Forceps
AE-2238
Size:22.00cm
Length



Single Tooth
Tanaculum
AE-2239
Size:24.00cm
Length



Dressing Forceps
AE-2240
Size:21.00cm
Length

Dressing Forceps
AE-2241
Size:25.00cm
Length



Tissue Forceps
AE-2242
Size:21.00cm
Length

Tissue Forceps
AE-2243
Size:25.00cm
Length

Double Isolated Premium Quality Gynecology – Hooks



Emmet Hook
AE-2244
Size:18cm
AE-2245
Size:25cm



Iris Hook
AE-2246
Size:18cm
AE-2247
Size:25cm



Straight Hook
AE-2248
Size:18cm
AE-2249
Size:25cm



Two-Prong Hook
AE-2250
Size:18cm
AE-2251
Size:25cm



Three-Prong Hook
AE-2252
Size:18cm
AE-2253
Size:25cm

Monopolar Laparoscopic Complete Forceps – Available in 6 Different Tips



	Article No.	Product Description and Length	Shaft Sizes
	AE-2254	Grasping Forceps with Teeth	Ø 5x330mm
	AE-2255	Punch Grasping Forceps with Hole	Ø 5x330mm
	AE-2256	Scissor Curved	Ø 5x330mm
	AE-2257	Grasping Forceps with Punch Teeth	Ø 5x330mm
	AE-2258	Grasping Forceps with Teeth Curved Shape	Ø 5x330mm
	AE-2259	Atraumatic Grasping Forceps	Ø 5x330mm

Ø6x4





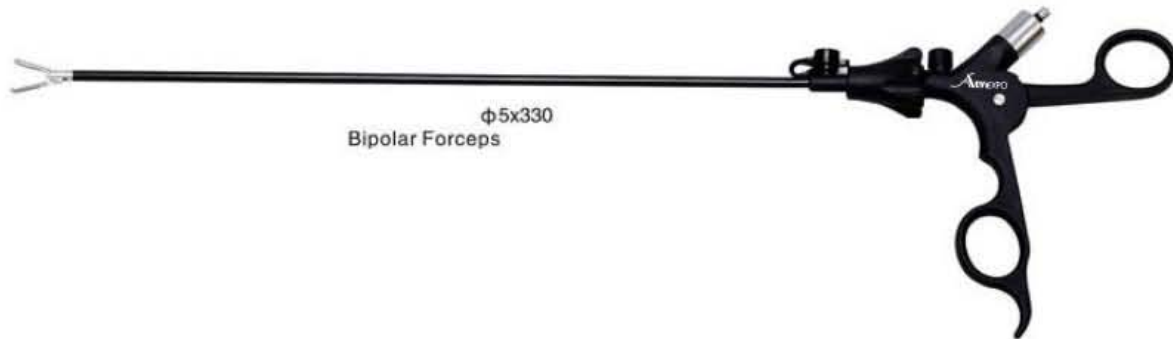

Ø4x4

Article No.	Product Description and Length	Wire Length
AE-2260	Monopolar Silicon Cable 4mm Banana Plugs For ESU Machines	3m, 5m
AE-2261	Monopolar Silicon Cable 8mm Banana Plugs For ESU Machines	3m, 5m

Bipolar Laparoscopic Complete Forceps – Available in 6 Different Tips



	Article No.	Product Description and Length	Shaft Sizes
	AE-2262	Grasping Forceps with Teeth	Ø 5x330mm
	AE-2263	Punch Grasping Forceps with Hole	Ø 5x330mm
	AE-2264	Scissor Curved	Ø 5x330mm
	AE-2265	Grasping Forceps with Punch Teeth	Ø 5x330mm
	AE-2266	Grasping Forceps with Teeth Curved Shape	Ø 5x330mm
	AE-2267	Atraumatic Grasping Forceps	Ø 5x330mm



Article No.	Product Description and Length	Wire Length
AE-2268	Bipolar Silicon Cable 4mm Banana Plugs International ESU Machines	3m, 5m
AE-2269	Bipolar Silicon Cable for ERBE Series ESU Machines	3m, 5m
AE-2270	Bipolar Silicon Cable for Martin Series ESU Machines	3m, 5m

General Laparoscopic Forceps – Available in Insulated & Non-Insulated Types

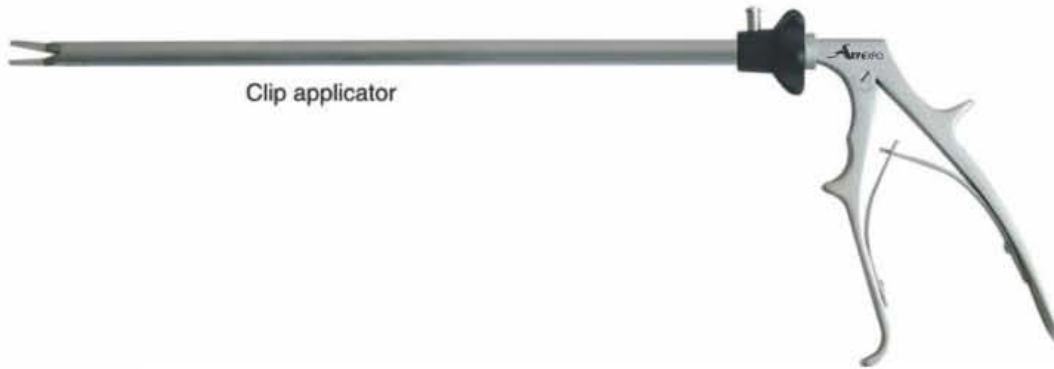

Article No.	Product Description and Length	Shaft Sizes
AE-2271	Clip Applicator	Ø 10x330mm



Article No.	Product Description and Length	Shaft Sizes
AE-2272	Needle-Holder Forceps	Ø 5x330mm



Article No.	Product Description and Length	Shaft Sizes
AE-2273	Grasping Forceps	Ø 5x330mm

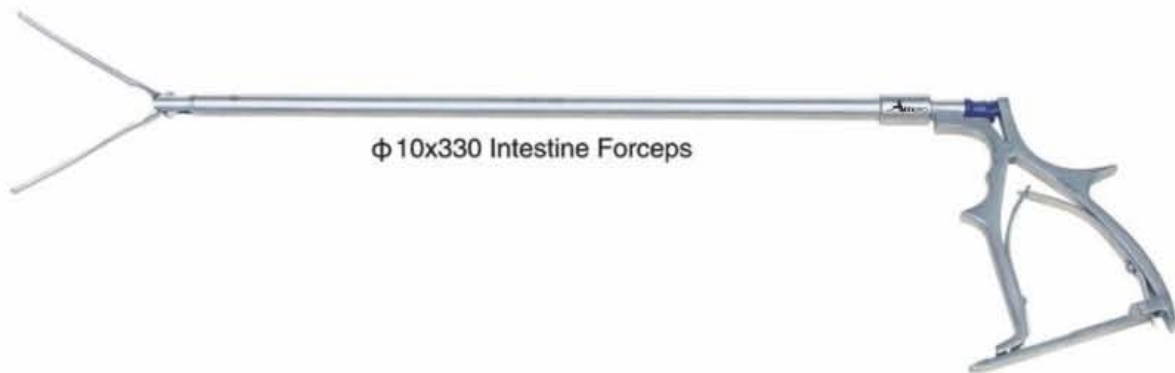

Article No.	Product Description and Length	Shaft Sizes
AE-2274	Intestine Forceps with Archer	Ø 10x330mm

General Laparoscopic Forceps – Available in Insulated & Non-Insulated Types



Article No.	Product Description and Length	Shaft Sizes
AE-2275	Straight Scissor with Rotating Clip	Ø 10x330mm



Article No.	Product Description and Length	Shaft Sizes
AE-2276	Single Action Scissor Curved	Ø 10x330mm

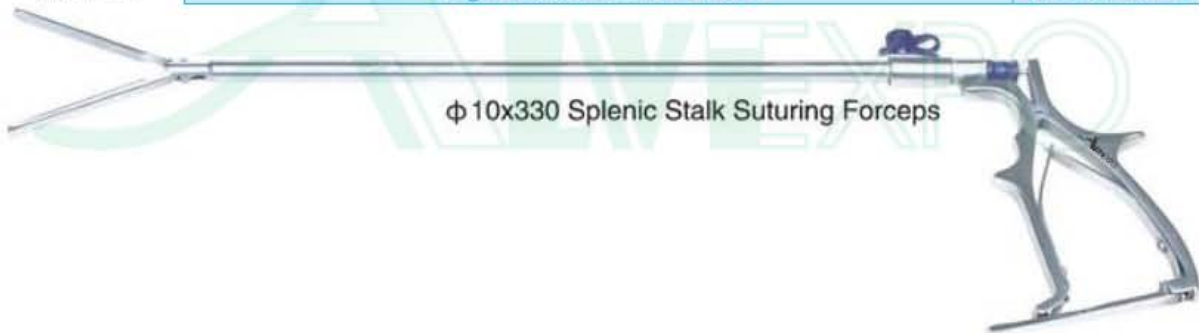

Article No.	Product Description and Length	Shaft Sizes
AE-2277	Splenic Stalk Suturing Forceps	Ø 10x330mm

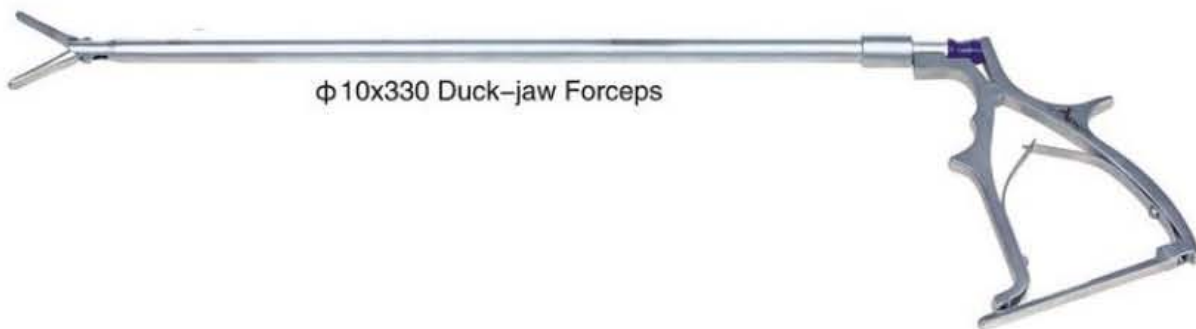

Article No.	Product Description and Length	Shaft Sizes
AE-2278	Duck-Jaw Forceps	Ø 10x330mm

General Laparoscopic Forceps – Available in Insulated & Non-Insulated Type

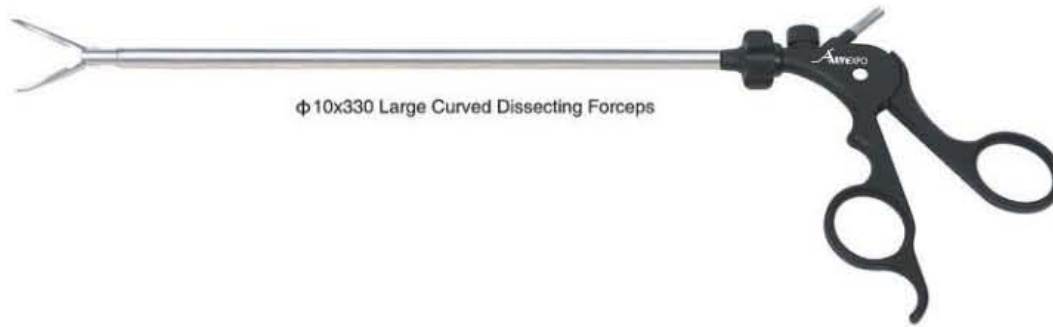

Article No.	Product Description and Length	Shaft Sizes
AE-2279	Large Curved Dissecting Forceps with 4mm Banana Plug Fitting	Ø 10x330mm

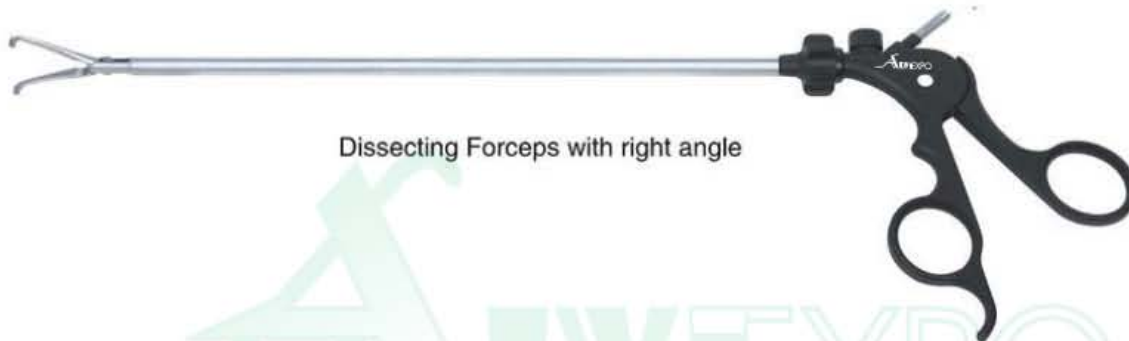

Article No.	Product Description and Length	Shaft Sizes
AE-2280	Dissecting Forceps with Right Angle with 4mm Banana Plug Fitting	Ø 10x330mm



Article No.	Product Description and Length	Shaft Sizes
AE-2281	Articulating Allis Grasper Forceps with 4mm Banana Plug Fitting	Ø 5x330mm



Article No.	Product Description and Length	Shaft Sizes
AE-2282	Articulating Atraumatic Grasper with 4mm Banana Plug Fitting	Ø 5x330mm

Disposable General Laparoscopic Forceps – Available in Plastic Handles



Article No.	Product Description and Length	Shaft Size
AE-2283	Disposable Smart Laparoscopic Hand Piece with Curved Scissor Tip	Ø 5x280mm

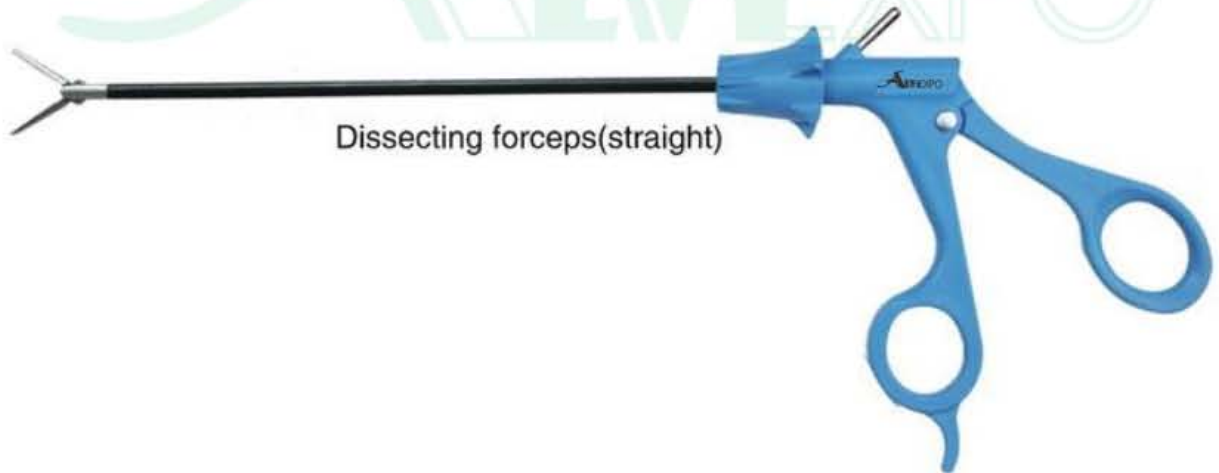

Article No.	Product Description and Length	Shaft Size
AE-2284	Disposable Standard Laparoscopic Forceps with Dissecting Tip	Ø 5x330mm

Monopolar Laparoscopic Electrode – Without Suction 4mm Banana Plug Fitting



	Article No.	Product Description and Length	Shaft Sizes
	AE-2285	Ball Electrode	Ø 5x330mm
	AE-2286	Needle Electrode	Ø 5x330mm
	AE-2287	Specula Electrode	Ø 5x330mm
	AE-2288	L Hook Electrode	Ø 5x330mm
	AE-2289	J Hook Electrode	Ø 5x330mm

Monopolar Laparoscopic Electrode – With Suction 4mm Banana Plug Fitting



	Article No.	Product Description and Length	Tip Sizes
	AE-2290	Ball Electrode	Ø 5x330mm
	AE-2291	Needle Electrode	Ø 5x330mm
	AE-2292	Specula Electrode	Ø 5x330mm
	AE-2293	L Hook Electrode	Ø 5x330mm
	AE-2294	J Hook Electrode	Ø 5x330mm



ALVIEXPO

Manufacturers & Exporters of Surgical Instruments

Industrial Estate Daska Road, Opposite Sialkot
Medical College Sialkot Pakistan

+92-332-8638800 / +92-310-7186560

alvi@skt.comsats.net.pk alviexpo@gmail.com

www.alviexpo.com

