



**DIAGNOSTIC SET
(ENT COMPLETE)
AE-001**

Consisting of Battery Handle (without Battery)
3 Ear Specula, 1 Nasel Specula,
2 Laryngeal Mirrors with Holder
1 Tongue Depressor Holder, 1 Bulb



**OTOSCOPE SET
AE-002**

Consisting of Battery Handle
(without Battery)
3 Ear Specula, 1 Nasel Specula,



**MAGILL
AE-003
17 cm, 6 3/4"**



**MAGILL
AE-004
20 cm, 8"**



**MAGILL
AE-005
25 cm, 10"**

LARYNGOSCOPE & ACCESSORIES



Laryngoskope und Zubehör
Laringoscopios y Accessories

Laryngoscopes et accessories
Laringoscopi ed accessori



**GUEDEL-NEGUS
AE-006**
Battery handle only
with for Laryngoscope
blades No. 1 to 4
complete, in case.



**MCINTOSH
AE-011**
Fiber Optic Laryngoscope set
with 4 blades
(fig. 01 to 04) in wooden/ rexin box.



Fig. 01
AE-007

Fig. 02
AE-008

Fig. 03
AE-009

Fig. 04
AE-010



**BATTERY HANDLE
AE-016**
without battery
Use with battery - Size C
(AE-007 – AE-010
AE-012 – AE-015)

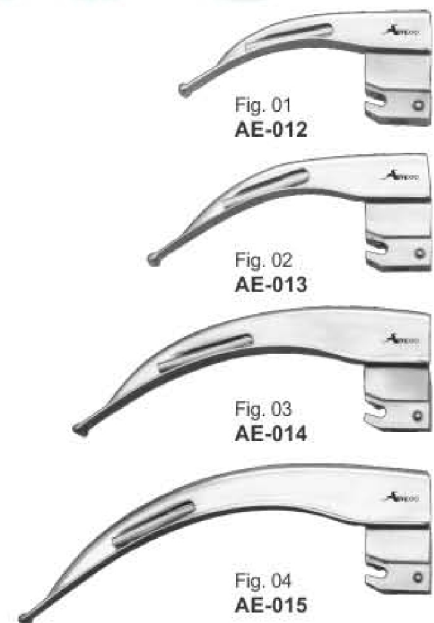

Fig. 01
AE-012

Fig. 02
AE-013

Fig. 03
AE-014

Fig. 04
AE-015

MC-INTOSH FIBER OPTIC LARYNGOSCOPE BLADE (English Pattern)

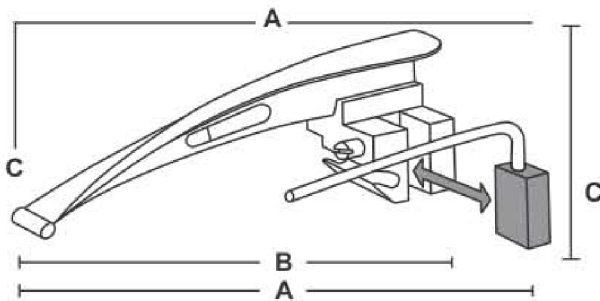

BLADE

Size	A	B	C	Working Length
0	77mm	53mm	14mm	55mm
1	95mm	72mm	43mm	70mm
2	111mm	86mm	44mm	78mm
3	133mm	109mm	44mm	108mm
4	151mm	129mm	44mm	133mm

Mc-Intosh Laryngoscope Fiber Optic

Halogen illumination. Manufactured from AISI 304 Stainless-Steel. Halogen illumination 2.5 V. The Bulb is inside the handle in order to simplify the sterilization of the blades. All blades and handles are interchangeable with other leading manufacturer. All sets can be combined as per your request, and delivered in Green plastic case.

Blades Availability:

- * Matt Finish
- * Mirror Finish
- * Sand Blast Finish
- * Pls, confirm in your order list

Mc-INTOSH FIBER OPTIC LARYNGOSCOPE SET HALOGEN ILLUMINATION

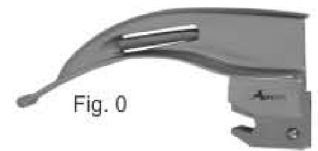

Fig. 0

AE-017 PEDIATRIC SET Set of 0,1,2 Blades Supplied in Green plastic case



Fig. 1

AE-018 STANDARD SET Set of 1,2,3 Blades Supplied in Green plastic case



Fig. 2

AE-019 ADULT SET Set of 1,2,3,4 Blades Supplied in Green plastic case

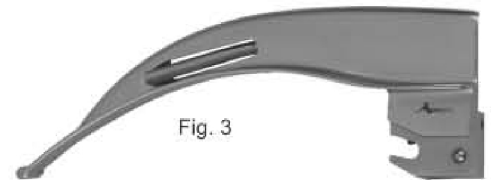

Fig. 3



Fig. 4



Laryngoscope Battery
Handle for Adult
C type 2 batteries



Mc-Intosh Fiber Optic Laryngoscope Set
Halogen Illumination
Manufactured by AISI:
304 Stainless Steel Material

LARYNGOSCOPE & ACCESSORIES



Laryngoskope und Zubehör
Laringoscopios y Accesorios

Laryngoscopes et accessories
Laringoscopi ed accessori

MC-INTOSH LARYNGOSCOPE

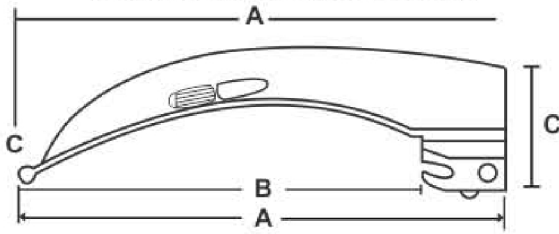

BLADE

Size	A	B	C	Working Length
0	80mm	58mm	30mm	55mm
1	97mm	76mm	36mm	70mm
2	111mm	88mm	36mm	78mm
3	133mm	112mm	36mm	108mm
4	154mm	131mm	38mm	133mm

Mc-Intosh Laryngoscope

Plastic case, Standard illumination. Manufactured from AISI 304 Stainless Steel Matt Type, Standard Illumination 2.5 V. All blades and handles are interchangeable with other leading manufacturer. All sets can be combined as per your request, and delivered in Gray plastic case.

Blades Availability:

- ★ Matt Finish
- ★ Mirror Finish
- ★ Sand Blast Finish
- ★ Pls, confirm in your order list

Conventional Laryngoscope Set

Mc-INTOSH LARYNGOSCOPE SET STANDARD ILLUMINATION

AVAILABLE SETS WITH BATTERY HANDLE

AE-020 PEDIATRIC SET
Set of 0,1,2
Blades
Supplied in Gray plastic case

AE-021 STANDARD SET
Set of 1,2,3
Blades
Supplied in Gray plastic case

AE-022 ADULT SET
Set of 1,2,3,4
Blades
Supplied in Gray plastic case



Fig. 0



Fig. 1



Fig. 2



Fig. 3



Fig. 4



Laryngoscope Battery Handle for Adult
C type 2 Batteries



With two Spare Bulbs



Mc-Intosh Laryngoscope Set
Standard Illumination
Manufactured From
Stainless Steel Material

LARYNGOSCOPE MILLER

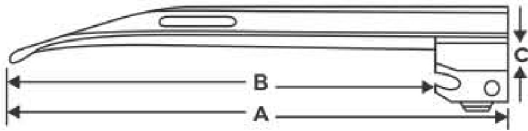

BLADE				
Size	A	B	C	Working Length
0	75mm	53mm	26mm	55mm
1	111mm	80mm	26mm	80mm
2	151mm	134mm	28mm	130mm
3	188mm	167mm	28mm	170mm
4	203mm	180mm	28mm	180mm

Mc-Intosh Laryngoscope

Plastic case, Standard illumination.
Manufactured from AISI 304 Stainless Steel.
All blades and handles are interchangeable
with other leading manufacturer. All sets
can be combined as per your request, and
delivered in Blue plastic case.

Blades Availability:

- ★ Matt Finish
- ★ Mirror Finish
- ★ Sand Blast Finish
- ★ Pls, confirm in your order list



Laryngoscope Battery
Handle for Adult C type
2 batteries



With two Spare
Bulbs

Conventional Laryngoscope Set

LARYNGOSCOPE SET OF CONVENTIONAL MILLER STANDARD ILLUMINATION

AVAILABLE SETS WITH BATTERY HANDLE

**AE-023
Pediatric Set**
Set of 3 Pcs
Blades 0,1,2
Supplied in
Blue plastic case



Fig. 1

**AE-024
Standard Set**
Set of 3 Pcs
Blades 1,2,3
Supplied in
Blue plastic case



Fig. 2

**AE-025
Adult Set**
Set of 4 Pcs
Blades 1,2,3,4
Supplied in
Blue plastic case



Fig. 3



Fig. 4



Laryngoscope Set of conventional Miller
Standard Illumination
Manufactured From Stainless Steel Material

DIAGNOSTIC SETS

Diagnostik-Bestestecke
Trousse à diagnostic

Juegos para diagnóstico
Astucci per diagnostica



Handle



Two laryngeal mirrors: n. 4 and 5



Specula

Professional Otoscope & Ophthalmology Set ENT Medical Diagnostic Set

AE-026

2.5 V Standard illumination for use with 2 batteries C type.

Including:

Otoscope Head: Luir Lock fitting.

Chrome plated.

Fix lens 4 x in plastic mount can be

removed for introduction of instruments.

Specula sizes: 2.5, 3.5 & 4.5 mm Included,

Ophthalmoscope head: Luir Lock fitting.

Lens selection wheel permits choice of corrective

lenses from 0 to - 20 and 0 to +20 diopters.

Single large circle aperture.

Bent-arm illuminator: pin contact fitting.

Nasal speculum: Chrome plated.

Two laryngeal mirrors: n. 4 and 5.

Battery handle: 28mm. For 2 cell C-batteries.

Chrome plated. For adjustment of all illumination.

Replacement bulb: 2.5 V

Diagnostic set is supplied in our new beautiful

look and quality Blue Case, which protect our quality

Products from moisturizing and damaging.

Bent-arm illuminator:
pin contact fitting.



With 2 spare Bulbs



Otoscope Head



Nasal speculum: Chrome plated.



Ophthalmoscope head



ENT Specula

DIAGNOSTIC SETS

Diagnostik-Bestestecke
Trousse à diagnostic

Juegos para diagnóstico
Astucci per diagnostica



DIAGNOSTIC PENTOSCOPE SET AE-027

2.5 V Standard illumination for use with 2 batteries type AA.

Consisting:

Universal Handle thread type fit for all Pentoscope Heads like.

- Otoscope Head.
- Ophthalmoscope Head.
- Throat Branch Head.
- Mouth Mirrors Head.

It have two exploring mirrors No. 4 & 5 mm. Its spare 06 disposable Plastic ear Canulas are with sizes 2 x 2.50 mm, 2 x 3.50 mm & 2 x 4.5 mm. On special order it can be as 2 x 1.5 mm for new born babies 2 x 2.5 mm for pediatric and 2 x 4 mm for adults, so it means total 06 canula also available in a plastic tube packing.

Sturdy adjustment mount bracket

2 spare 2.5 V bulb.

Pentoscope set battery handle is operating with two AA size batteries.

This Pentoscope set Packed in our new beautiful Blue Colour plastic case in same blue inner packing material. Spare parts also available of any item.



With 2 spare Bulbs



Mouth Mirrors Head



Standard illumination



Otoscope Head



Sturdy Adjustment Mount Bracket



Plastic ear Canulas

PERCUSSION HAMMERS



Perkussionshämmer
Martillos de percusion

Marteaux-percuteurs
Martelli percussori



NEURO-DUOFLEX
AE-028
22 cm, 8 3/4"



DEJERINE
AE-029
20 cm, 8"

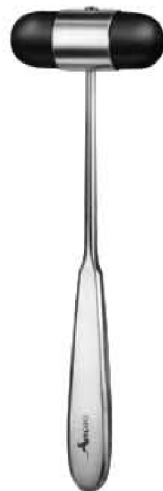

DEJERINE
AE-030
20 cm, 8"



TROEMNER
AE-031 145 g
AE-032 175 g
AE-033 235 g
24.5 cm, 9 3/4"
spare rubber



TROEMNER-SIMPLEX
AE-034
21 cm, 8 1/4"



BUCK
AE-035
18.5 cm, 7 1/4"



BUCK HAMMER
AE-036
18 cm, 7"



TAYLOR
AE-037 18 cm, 7"
AE-038 20 cm, 8"



TAYLOR
AE-039
18 cm, 7"



BABINSKY
AE-040
22 cm, 8 3/4"



BABINSKY
AE-041
22 cm, 8 3/4"



RABINER
AE-042
25.5 cm, 10"
with needle & brush



BERLINER
AE-043
20 cm, 8"

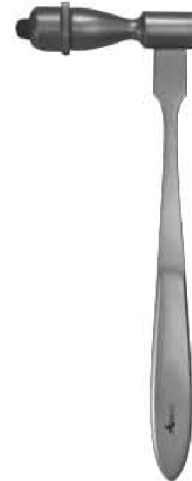

TRAUBE
AE-044
16 cm, 6 1/4"



WARTENBERG
AE-045
19 cm, 7 1/2"

Ø 1.5 mm



COUPLAND
AE-046

Ø 2.0 mm



BYRD
AE-047 1.5 mm
AE-048 2.5 mm
AE-049 3.5 mm

Ø 5 mm



DE-BAKEY
AE-050
16 cm, 5"
with finger cut-off
and stylet

Ø 4 mm



Ø 9 mm

AE-051
19 cm, 7 1/4"
cut-off

Ø 5 mm



Ø 9 mm

DE-BAKEY
AE-052
27 cm, 10 3/4"
with finger cut-off
and stylet



AE-053 Ø 4.5 mm
AE-054 Ø 5.5 mm
17.5 cm, 7"
Nasal suction tubes



LOPEZ-REINKE
AE-055
23.5 cm, 9"
tonsil dissector with
suction device



Ø 6-9 mm

FERGUSON
AE-056 Ø 4.0 mm
18 cm, 7"
insulated, with finger
cut-off and stylet, thumb
piece 90° to curved, with
Luer hub



Ø 6-9 mm

FRAZIER
AE-057 Ø 3.0 mm
AE-058 Ø 5.0 mm
18 cm, 7"
insulated, with finger
cut-off and stylet, thumb
piece 90° to curved, with
Luer hub



Ø 6-9 mm

AE-059
18 cm, 7"
Ø 5.0 mm diam., Tip
6.5 mm wide nasal
section tube, with
luer hub

DISSECTING KITS



Diagnostik-bestecke
Diagnostic Sets

Estuches de diagnostico
Combinazioni per diagnostica

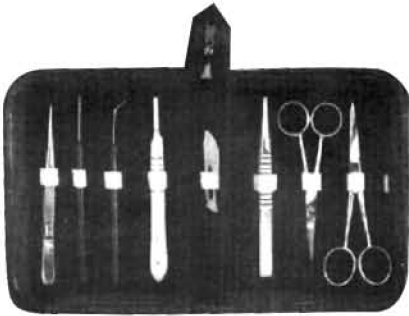

AE-060

Set of 9 Pcs.

- Dissecting Forceps 11.5cm Sharp Point.
- Teasing needle Sharp STR.
- Teasing Needle Sharp Angular.
- B.P Handle No.4.
- Blade No. 22.
- Thumb Forcep T.O.E 13cm.
- Dissecting Scissor STR 11.5cm.
- Dissecting Scissor STR 13cm.
- Zipper Case Inside Red Velvet.

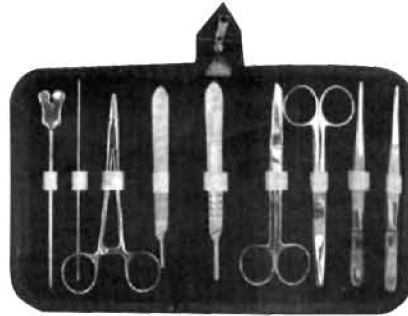

AE-061

Set of 10 Pcs.

- Grooved Director with Tongue Tie 14cm.
- Probe Double 14cm.
- Mayo Hegar Needle Holder 14cm.
- B.P Handle No.3
- B.P Handle No.4
- Dressing Scissor 14cm S/B STR.
- Dressing Scissor 14cm S/B CVD.
- Dressing Forcep 1x2 teeth 14cm.
- Dressing Forcep Serrated 14cm.
- Zipper Case Inside Red Velvet.



AE-062

Set of 10 Pcs.

- Probe Double 13cm.
- 2PCS. Scalpel S.S.
- Grooved Director With Tongue Tie 14cm
- Mayo Hegar Needle Holder 14cm.
- Dissecting Forceps 14cm 1x2 Teeth.
- Dressing Forceps 14cm Serrated.
- Dressing Scissor 14cm S/B STR.
- Dressing Scissor 14cm S/B CVD.
- Zipper Case Inside Red Velvet.



AE-063

Set of 10 Pcs.

- Blow Pipe.
- 3PCS Scalpel.
- Dissecting Forceps 14cm.
- Grooved Director With Tongue Tie 14cm
- Triple Chain Hook.
- Dressing Scissor Probe Pointed 14cm.
- Probe Double 14 cm.
- Zipper Case Inside Red Velvet.



DISSECTING SET

AE-064 Containing 9 Instruments



AE-065

C Section Set.

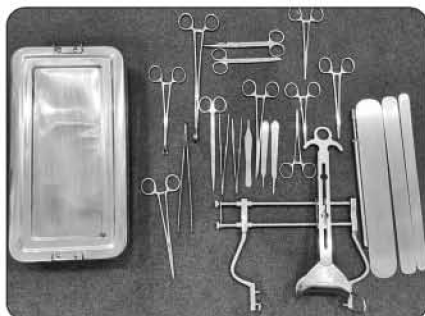

AE-066

Basic Laparotomy set



AE-067

D&C kit