

Plastic Surgery

Ethmoid Bone Forceps

	Maulbreite Jaw width Ancho de boca Largeur de mors Larghezza dei morsi			
		a = 12 cm - 4 3/4"	a = 12 cm - 4 3/4"	a = 12 cm - 4 3/4"
# 1	3,0 mm	EG-1152-00-A	EG-1152-01-A	EG-1152-02-A
# 2	3,6 mm	EG-1152-00-B	EG-1152-01-B	EG-1152-02-B
# 3	4,2 mm	EG-1152-00-C	EG-1152-01-C	EG-1152-02-C
# 4	4,8 mm	EG-1152-00-D	EG-1152-01-D	EG-1152-02-D
# 5	5,6 mm	EG-1152-00-E	EG-1152-01-E	EG-1152-02-E

Weil-Blakesley

P₁₀
EG-1152-02

Feder
Pen
Pluma
Plume
Piuma

130 mm
EG-1152-01

Federhalter
Pen holder
Porta-plumas
Porte-plume
Porta-piuma

Gubisch

Plastic Surgery

Micro Blade Holder --- Micro Blades

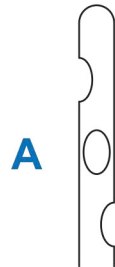

drei Löcher, diagonal
 three holes, diagonal
 tres orifi cios, diagonal
 trois trous, diagonal
 tre fori, diagonale

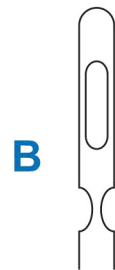

ein zentrales Loch
 zwei laterale Löcher
 one central hole
 two lateral holes
 un orifi cio central
 dos orifi cios laterales
 un trou central
 deux trous latéraux
 un foro centrale
 due fori laterali

Ø 3,0 mm Ø 4,0 mm Ø 5,0 mm Ø 6,0 mm



200 mm	300 mm	300 mm	300 mm
EG-1153-00-A	EG-1153-00-B	EG-1153-00-C	EG-1153-00-D
300 mm	300 mm		
EG-1153-00-E	EG-1153-00-F		

Ø 4,0 mm Ø 5,0 mm



300 mm	300 mm
EG-1153-01-A	EG-1153-01-B



Handles for cannulas
EG-1153-02

Plastic Surgery

Breast Dissectors



EG-1154-01-A	EG-1154-01-B
360 mm	360 mm

Breast Dissectors

EG-1154-00-A	340 mm
EG-1154-00-B	370 mm

Breast Dissectors

EG-1154-02

Plastic Surgery

Breast Retractors

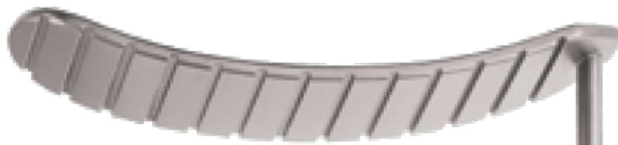
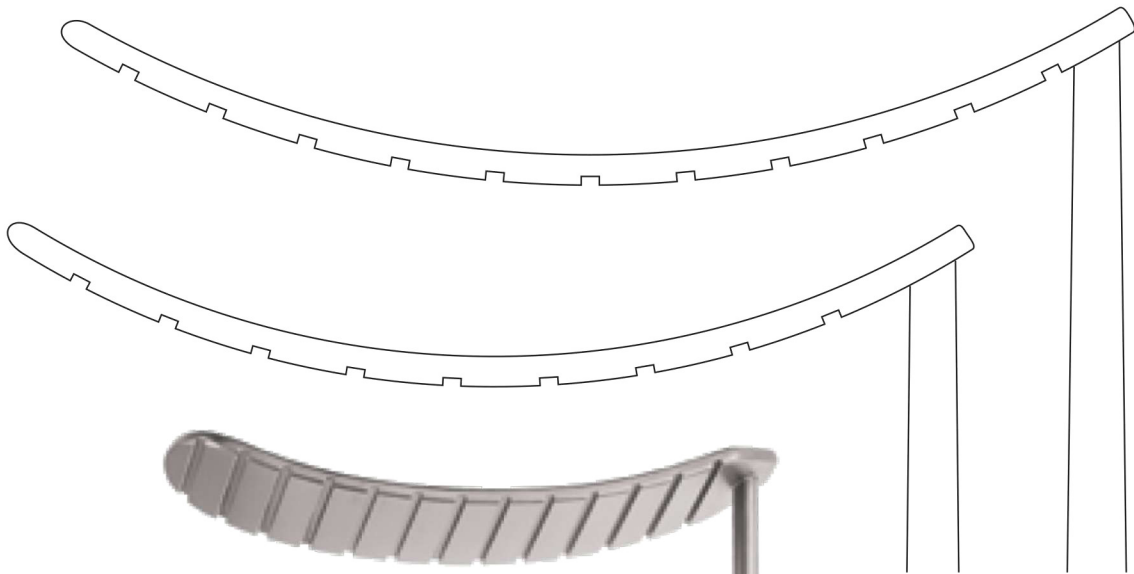

EG-1155-00-A	EG-1155-00-B
125 × 30 mm	140 × 30 mm
270 mm - 10¾"	270 mm - 10¾"

This curved retractor is especially applicable to all types of breast surgeries, axilla dissections and for sentinel lymph node biopsies, allowing a clear preparation.



Plastic Surgery

Abdominal Retractors for Lipoabdominoplasty

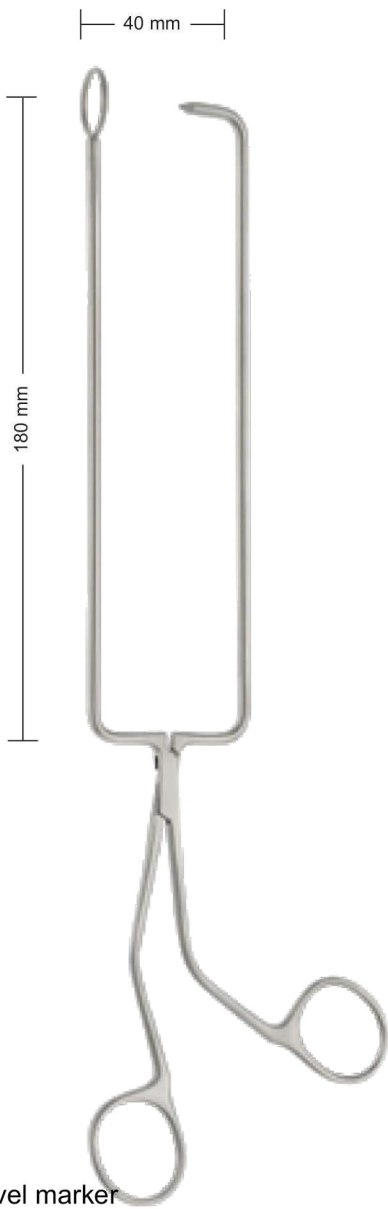

Navel marker
290 mm
EG-1156-01

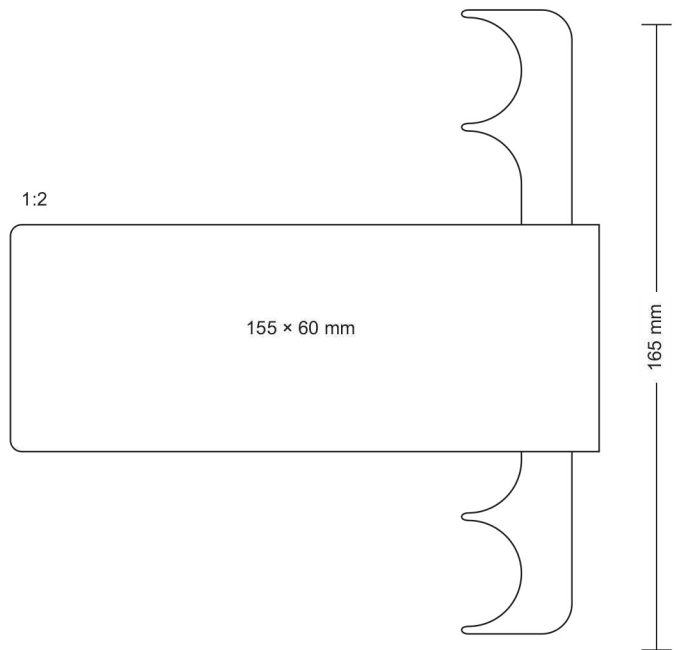

zerlegbar
dismantable
desmontable
démontable
smontabile

Saldanha-Solz
200 mm
EG-1156-00

Different Container



0.75 l	165 mm Ø x 60 mm	EG-1157-00
1.00 l	175 mm Ø x 70 mm	EG-1157-01
2.00 l	220 mm Ø x 80 mm	EG-1157-02
3.00 l	240 mm Ø x 110 mm	EG-1157-03
4.50 l	275 mm Ø x 115 mm	EG-1157-04
6.00 l	290 mm Ø x 125 mm	EG-1157-05
6.00 l	310 mm Ø x 120 mm	EG-1157-06
8.50 l	345 mm Ø x 125 mm	EG-1157-07
11.00 l	380 mm Ø x 130 mm	EG-1157-08

Schüsseln und Laborschalen, matt, 18/8 rostfrei
Bowls, tarnished, 18/8 stainless steel

Coupoles, depoli, 18/8 inoxydable
Palanganas, 18/8 inoxidable
Scodelle, inossidabile 18/8



0.05 l	40 mm Ø x 19 mm	EG-1157-09
0.07 l	61 mm Ø x 30 mm	EG-1157-10
0.14 l	80 mm Ø x 40 mm	EG-1157-11
0.35 l	116 mm Ø x 50 mm	EG-1157-12
0.45 l	128 mm Ø x 55 mm	EG-1157-13
0.70 l	147 mm Ø x 65 mm	EG-1157-14



170 mm x 95 mm x 25 mm	EG-1157-15
200 mm x 95 mm x 30 mm	EG-1157-16
250 mm x 125 mm x 35 mm	EG-1157-17
275 mm x 140 mm x 40 mm	EG-1157-18

Nierenschalen, matt, 18/8 rostfrei
Kidney bowls, tarnished, 18/8 stainless steel

Haricots, depoli, 18/8 inoxydable
Riñoneras, 18/8 inoxidable
Baccinella renifoEGe, 18/8 inossidabile



0,05 l	50mm Ø x 50 mm	EG-1157-19
--------	----------------	-------------------

Medizinbecher, graduert, matt, 18/8 rostfrei
Medicine cup, graduated, tarnished, 18/8 stainless steel

Timbale, graduée, depolie, 18/8 inoxydable
Vaso, graduado, mate, 18/8 inoxidable
Recipiente, graduato, 18/8 inossidabile

Plastic Surgery

Instruments Trays Make of Stainless Steel



Mit Deckel- und Bodenlochung mit Textil-Langzeitfiltern für Dampfsterilisation
With lid and bottom perforation with textil "LongteEG" filters for steam sterilisation
 Couvercle et boîtier perforé avec filtre en textile pour stérilisation à vapeur
Con perforación en tapa y fondo, con filtros en tejido para esterilización a vapor
 Con filtri tessili, per la sterilizzazione a vapore

Silikon-Andrückleisten zum Fixieren der Instrumente
Silicone protective strips for fixation of instruments

Tapis en silicone pour fixer les instruments
Tiras de silicon para fijar los instrumentos
 Righe di silicone per fissare gli strumenti

Silikon-Noppenstreifen zur schonenden Auflage der Instrumente
Silicon strips for a soft and protective storage of the instruments

Tapis en silicone pour la protection des instruments
Mata de silicon para proteger los instrumentos
 Stuoie di silicone per proteggere gli strumenti

1 herausnehmbare Siebplatte
1 removable tray insert
 1 tableau pour sortir
1 placa para sacar
 1 cestello

Kennzeichnungsschilder nach Wahl (Farbe und Text)
Marking plate for selection: colour and description

Plaque d'identification (texte et couleur selon demande)
Placas de identificación a opción (color y texto)
 Placche d'identificazione (colore a scelta)

280 x 195 x 55mm	265x 255 x 55mm	380x 260 x 55mm	200x 140 x 55mm	470x 250 x 55 mm
EG-1158-00-A	EG-1158-00-B	EG-1158-00-C	EG-1158-00-D	EG-1158-00-E

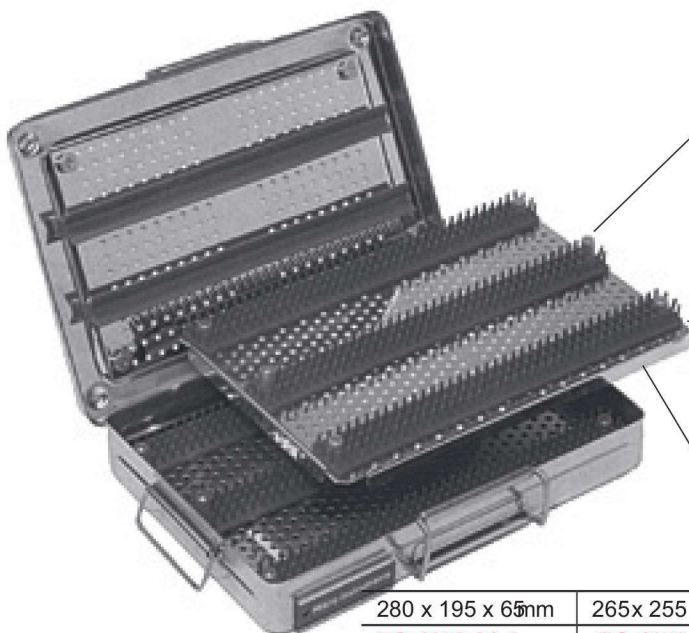

wärmeisolierende Halteknöpfe zum Herausheben
heatisolated handles

pins isolés pour sortir des tableaux
Pernos aislados para sacar las placas
 maniglia a foEGA di botone

2 herausnehmbare Siebplatten
2 removable tray inserts
 2 tableaux detachables
2 placas para sacar
 2 cestelli

Silikon-Andrückleisten an der Unterseite des Siebes
Silicone protective strips at the lower side of the tray
 Tapis de silicone à la partie inférieure des tableaux
Tiras de silicon a bajo de las placas
 Righe di silicone

280 x 195 x 65mm	265x 255 x 65mm	380x 260 x 65mm	200 x 140 x 65mm	470x 250 x 65 mm
EG-1158-01-A	EG-1158-01-B	EG-1158-01-C	EG-1158-01-D	EG-1158-01-E



Ramiraz Cobra Cannula

Stainless Steel. Designed to shield surrounding tissue
Unique cobra shaped hood to aid in tissue elevation.
Can be used with 4 mm or 5 mm endoscopes.
Single Stop-Cock for 5 mm Scope
Low Profile for 5 mm Scope Without Stop-Cock

EG-1159-01



Endoscopic Plastic Scope

Stainless Steel. Thirty degree rod lens. Steam autoclavable endoscope.

EG-1159-00-A

175 mm 5 mm Ø

EG-1159-00-B

175 mm 4 mm Ø

EG-1159-00-C

175 mm 10 mm Ø

EG-1159-00-D

330 mm 10 mm Ø

EG-1159-00-E

330 mm 10 mm Ø

Plastic Surgery

Endoscopic Plastic Instruments



Danial Forehead Cannula
Stainless Steel. Designed to shield surrounding tissue.

EG-1160-00



Fenestrated Forehead Cannula
Stainless Steel. Unique Fenestrated Hood intended for dissection and Greater Elevation. Designed to shield Surrounding Tissue

EG-1160-01-A

7 x 17 mm

EG-1160-01-B

12 x 23 mm



Inline Ergo Style Abdominal Needle Holders

EG-1160-02

320 mm



a

b

EG-1161-00

a = 120 mm b = 85 mm

Front Side



Back Side

Plastic Surgery

Gonzallo Retractors



Gonzalez Detacher
 260 mm
EG-1162-01



gonzalez straight blade
 320 mm
 20 mm wide
EG-1162-02



320 mm
 30 mm wide
EG-1162-03



Gonzalez Retractors
 180 mm
 20 mm Wide
EG-1162-04

Gonzalez Retractors
 200 mm
EG-162-05

Plastic Surgery

Gubisch Rhinoplasty Set



EG-124-11-B



EG-118-12-B



EG-113-17-A



EG-113-14-A



EG-147-12-TC



EG-148-12-B1



EG-147-12-B1



EG-150-20-A1



EG-103-15T

EG-102-07-B

Item number	Description	Quantity
EG-103-15T	Scalpel blade · figure 15 · sterile · packing unit 100 pieces	1
EG-102-07-B	Scalpel handle · no. 7 · long · 16.5 cm	1
EG-124-11-B	Delicate scissors · straight · 12 cm	1
EG-118-12-B	Operating scissors · straight · sharp/blunt · 13 cm	1
EG-113-17-A	MAYO-STILLE HM Dissecting scissors · curved · 17 cm	1
EG-113-14-A	REYNOLDS (JAMESON) Dissecting scissors · curved · 14 cm	1
EG-147-12-TC	ADSON HM Dressing forceps · 12 cm	1
EG-148-12-B1	MICRO-ADSON Tissue forceps · 1 × 2 teeth · 12 cm	2
EG-147-12-B1	ADSON-BROWN Tissue forceps · 7 × 7 teeth · 12 cm	1
EG-150-20-A1	Dressing forceps · serrated · 20 cm	1

Plastic Surgery

Daniel Rhinoplasty Set



Plastic Surgery

Daniel Rhinoplasty Set

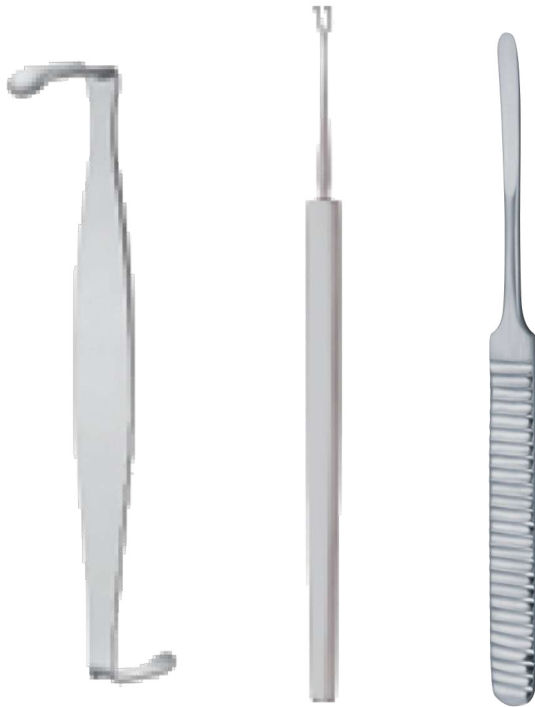

EG-191-11

EG-181-13-A

EG-1129-16-B

Item number	Description	Quantity
EG-103-15T	Scalpel blade sterile packing unit 100 pieces	1
EG-102-07-B	Scalpel handle · no. 7 · long · 16.5 cm	1
EG-113-14-A	REYNOLDS (JAMESON) Scissors · curved · 14 cm	1
EG-147-12-TC	ADSON HM Dressing forceps · 12 cm	1
EG-148-12-B1	MICRO-ADSON Tissue forceps · 1 × 2 teeth · 12 cm	2
EG-147-12-B1	ADSON-BROWN Tissue forceps · 7 × 7 teeth · 12 cm	1
EG-150-20-A1	Deuhrssen Dressing forceps · serrated · 20 cm	1
EG-152-17-C	Dressing forceps · 16 cm	1
EG-197-13	GUBISCH HM Needle holder · fine · 12.5 cm	1
EG-1100-14	CRILE-WOOD HM (DEBAKEY HM) Needle holder · fine · 15 cm	1
EG-168-12-B	MICRO-HALSTED Hemostatic forceps · curved · 12.5 cm	2
EG-1144-13	BACKHAUS Towel clamp · 13 cm	3
EG-175-25-A1	RAMPLEY Sponge forceps · straight · 24 cm	2
EG-187-16	RAGNELL Delicate retractor · double-ended · 16 cm	2
EG-191-11	CRILE Retractor · double-ended · 11 cm	1
EG-176-00	BARSKY Skin hook · 1 tooth · 15 cm	1
EG-177-16-B	JOSEPH Delicate retractor · 2 teeth · sharp · 17 cm	2
EG-181-13-A	GUTHRIE Delicate retractor · 2 teeth · sharp · 13 cm	2
EG-1129-16-B	WILLIGER Raspatory · 5 mm · 16 cm	1

Plastic Surgery

Gubisch Rhinoplasty Set



EG-1123-20-D



EG-1121-20-A



EG-1140-20



EG-173-16-B



EG-1137-15-A



EG-1137-15-B



EG-1137-00



EG-1137-01 TO 10



EG-1140-21



EG-1125-14



EG-1135-00

Item number	Description	Quantity
EG-1121-20-A	GUBISCH Osteotome · with aluminium handle · 2 mm · 18.5 cm	1
EG-1121-20-B	GUBISCH Osteotome · with aluminium handle · 3 mm · 18.5 cm	1
EG-1123-20-D	FANOUS-GUBISCH Osteotome · with thorn · 4 mm · 19.5 cm	1
EG-1140-20	CAPLAN Nasal septum scissors · angled · 20 cm	1
EG-173-16-B	AIACH-GUBISCH Forceps · 16 cm	1
EG-173-16-C	AIACH-GUBISCH Forceps · 16 cm	1
EG-1137-15-A	Handle for nasal rasps · 14 cm	1
EG-1137-15-B	Handle for nasal rasps · double-ended · 14 cm	1
EG-1137-00	Wrench · for nasal rasps	1
EG-1137-02	Rasps insert HM · figure 2	1
EG-1137-05	Rasps insert HM · figure 5	1
EG-1137-01	Rasps insert HM · figure 1	1
EG-1137-03	Rasps insert HM · figure 3	1
EG-1137-04	Rasps insert HM · figure 4	1
EG-1137-06	Rasps insert HM · figure 6	1
EG-1137-07	Rasps insert HM · figure 7	1
EG-1137-08	Rasps insert HM · figure 8	1
EG-1137-09	Rasps insert HM · figure 9	1
EG-1137-10	Rasps insert HM · figure 10	1
EG-1140-01	Protective guard	1
EG-1140-21	GUBISCH-RUBIN HM Septal morselizar · 20 cm	1
EG-1125-14	LINDEMANN Cutting burr · shank-Ø 2.35 mm · 45 mm	1
EG-1125-14	LINDEMANN Cutting burr · shank-Ø 2.35 mm · 44.5 mm · Ø 1.4 mm	1
EG-1125-14	LINDEMANN Cutting burr · shank-Ø 2.35 mm · 70 mm · Ø 1.4 mm	1
EG-1135-00	BUCHWALD Tongue spatula · 18/23 mm · 18 cm	1

Plastic Surgery

Gubisch Rhinoplasty Set



EG-1135-01



EG-1125-07

EG-182-16-A3



EG-1134-13-B1



EG-1130-16



EG-1141-16



EG-1141-31



EG-179-10



EG-1120-19-A



EG-1132-16



EG-1152-00-C



EG-1151-00-D



EG-1136-17-A

Item number	Description	Quantity
EG-1135-01	CASTROVIEJO Caliper · measuring range 20 mm · 8 cm	1
EG-182-16-A3	DESMARRES Lid retractor · figure 2 · 14 cm	1
EG-1125-07	Cutting burr · barrel style · Ø 5 mm · shank Ø 2.35 mm · 7 cm	1
EG-1134-13-B1	KILLIAN Nasal speculum · figure 4 · 90 mm · dismantable · 14 cm	1
EG-1152-00-C	WEIL-BLAKESLEY Nasal forceps · straight · 4.2 mm · 12 cm	1
EG-1130-16	FREER Mucosa knife · 16 cm	1
EG-1132-16	COTTLE Nasal speculum · 50 mm · 13 cm	1
EG-1141-16	HARALDSSON Suction elevator · Ø 3 mm · 18.5 cm	1
EG-1141-31	DANIEL Spina nasalis awl · 16 cm	1
EG-1151-00-D	COTTLE Cartilage crusher	1
EG-179-10	GUBISCH-KILNER Alar retractor · 10 mm · 8 cm	1
EG-1136-17-A	GUBISCH-AUFRICHT Nasal retractor · 17 cm · 30 × 6/10 mm	1
EG-1136-17-B	GUBISCH-AUFRICHT Nasal retractor · 17 cm · 50 × 6/12 mm	1
EG-1120-19-A	COTTLE-GUBISCH Chisel · graduated · hollow cut · 5 mm · 18 cm	1
EG-1120-19-B	COTTLE-GUBISCH Chisel · graduated · hollow cut · 12 mm · 18 cm	1

Plastic Surgery

Gubisch Rhinoplasty Set



EG-3151-08



EG-152-17-C



EG-197-13



EG-197-15-TC



EG-168-12-A



EG-171-15-A



EG-1129-16-B



EG-1144-13



EG-176-00



EG-177-16-B



EG-181-13



EG-1130-20-A



EG-1129-19-C



EG-1126-15-A

EG-1115-26



EG-1152-01



EG-2287-09

Item number	Description	Quantity
EG-158-23	NELSON Tissue grasping forceps · 15 cm	1
EG-152-17-C	GRUENWALD Bayonet forceps · 16 cm	1
EG-197-13	GUBISCH HM Needle holder · extra-fi ne · 12.5 cm	1
EG-197-15-TC	CRILE-WOOD HM Needle holder · fi ne · 15 cm	1
EG-168-12-A	MICRO-HALSTED Hemostatic forceps · straight · 12.5 cm	1
EG-168-12-B	MICRO-HALSTED Hemostatic forceps · curved · 12..5 cm	1
EG-171-15-A	LERICHE Hemostatic forceps · straight · 15 cm	1
EG-170-14-A1	PEAN Hemostatic forceps · straight · 14 cm	2
EG-1144-13	BACKHAUS Towel clamp · 13 cm	1
EG-176-15-A	Dressing forceps · curved · 17.5 cm	1
EG-175-15-B	GROSS Dressing forceps · curved · 20 cm	1
EG-170-00	BARSKY Skin hook · 1 tooth · 15 cm	2
EG-177-16-B	JOSEPH Delicate retractor · 2 teeth · 17 cm	1
EG-181-13	GUTHRIE Delicate retractor · 2 teeth · sharp · 13 cm	1
EG-1130-20-A	LANGENBECK Elevator · thin · 7 mm · 20 cm	1
EG-1129-19-C	FREER Raspatory · sharp/sharp · 5 mm · 19 cm	1
EG-1129-16-B	WILLIGER Raspatory · 5 mm · 16 cm	1
EG-1126-15-A	McKENTY Raspatory · 3 mm · 15 cm	1
EG-1126-15-B	McKENTY Raspatory · 4 mm · 15 cm	1
EG-1115-26	Mallet · made of Novotex plastic · Ø 45 mm · 240 g · 26 cm	1
EG-1152-01	GUBISCH Pen holder · 13 cm	1
EG-1152-02	Pen · for pen holder 44.90.70 · packing unit 10 pieces	1
EG-2287-09	Round bowl · Ø 40 mm · height 20 mm · 0.02 l	1
EG-2287-10	Round bowl · Ø 60 mm · height 30 mm · 0.06 l	1
EG-2287-11	Round bowl · Ø 80 mm · height 40 mm · 0.16 l	1
EG-2287-12	Round bowl · Ø 110 mm · height 55 mm · 0.40 l	1

Plastic Surgery

Daniel Rhinoplasty Set



EG-1126-15-A



EG-1115-26



EG-106-04



EG-1157-10



EG-1157-19



EG-1135-01



EG-1132-16



EG-1141-16



EG-1126-15-A

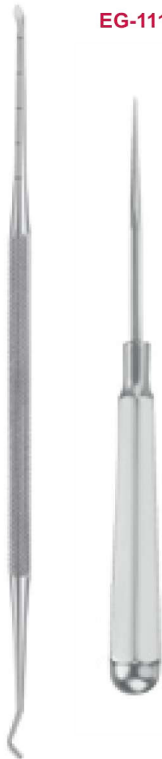

EG-1126-15-A



EG-1126-15-A



EG-1151-00-D



EG-193-11

EG-179-10



EG-1121-20-A



EG-1120-17



EG-1123-20-D

Item number	Description	Quantity
EG-1126-15-A	McKENTY Raspatory · 3 mm · 15 cm	1
EG-1115-26	Mallet · made of Novotex plastic · Ø 45 mm · 240 g · 26 cm	1
EG-179-00-A	Ruler · graduated in mm and inches · 15 cm	1
EG-153-10	Round bowl · Ø 60 mm · height 30 mm · 0.06 l	1
EG-153-12	Round bowl · Ø 110 mm · height 55 mm · 0.40 l	1
EG-153-19	Medicine cup · graduated · 50 cc	1
EG-1135-01	CASTROVIEJO Caliper · measuring range 20 mm · 8 cm	1
EG-1132-16	COTTLE Nasal specula · 50 mm · 13 cm	1
EG-1141-16	HARALDSSON Suction elevator · Ø 3mm · 18.5 cm	1
EG-1125-20	DANIEL-CAKIR Subperichondrial/subperiosteal elevator · 20 cm	1
EG-1127-21	COTTLE-DANIEL Septal elevator · 21 cm	1
EG-1141-31	DANIEL Spina nasalis awl · 16 cm	1
EG-1151-00-D	GUBISCH Cartilage crusher · 65 × 30 mm	1
EG-179-10	GUBISCH-KILNER Alar retractor · 10 mm · 8 cm	1
EG-193-11	AUFRICHT-DANIEL Nasal retractor · 11 cm	1
EG-1121-20-A	GUBISCH Osteotome · straight · 2 mm · 18.5 cm	1
EG-1121-20-B	GUBISCH Osteotome · straight · 3 mm · 18.5 cm	1
EG-1120-17	CAKIR Osteotome · straight · without guide	1
EG-1123-20-D	FANOUS-GUBISCH Osteotome · with guide · 3 mm · 19.5 cm	1

Plastic Surgery

Gubisch Rhinoplasty Set



EG-124-11-A



EG-117-14-A-SU



EG-110-03-B



EG-114-16-B



EG-137-18



EG-136-13

Item number	Description	Quantity
EG-124-11-A	SC Plus iris scissors straight · 11.5 cm	1
EG-117-14-A-SU	MAYO Dissecting scissors · supercut plus · straight · 14 cm	1
EG-117-17-B-SU	MAYO Dissecting scissors · supercut plus · curved · 17 cm	1
EG-110-03-B	METZENBAUM Dissecting scissors · supercut plus · curved · 18 cm	1
EG-114-16-B	KELLY Dissecting scissors · supercut plus · curved · 16 cm	1
EG-137-18	HEYMANN Rhinoplasty scissors · supercut · 18 cm	1
EG-136-13	FOMON Rhinoplasty scissors · supercut plus · angled downwards · 13 cm	1

Plastic Surgery

Face and Forehead Lift Instruments Set



EG-148-12-B1



EG-147-12-B1



EG-151-20-A



EG-103-15T

EG-102-07-B



EG-1144-13-A



EG-1153-00-A



EG-1153-02



EG-197-13



EG-198-15-TC



EG-179-01-A



EG-177-16-B



EG-190-18-C



EG-189-19



EG-192-21-E

Plastic Surgery

Face and Forehead Lift Instruments Set

Item number	Description	Quantity
EG-103-15T	Scalpel blade · figure 15 · sterile · packing unit 100 pieces · sterile	1
EG-102-07-B	Scalpel handle · no. 7 · long · 16.5 cm	1
EG-148-12-B1	MICRO-ADSON Tissue forceps · 1 × 2 teeth · 12 cm	1
EG-147-12-B1	ADSON-BROWN Tissue forceps · 7 × 7 teeth · 12 cm	1
EG-151-20-A	SELECT Tissue forceps · 1 × 2 teeth · 20 cm	1
EG-1153-00-A	Liposuction cannula · Ø 3.0 mm · three holes · diagonal · 20 cm	1
EG-1153-02	Handle for cannula · with hole · tube connection · rotatable · 13 cm	1
EG-197-17	GUBISCH HM Needle holder · extra-fine · 12.5 cm	1
EG-198-15-TC	BABY CRILE-WOOD HM Needle holder · fine · 15 cm	1
EG-1144-13-A	BACKHAUS Towel clamp · 8.5 cm	6
EG-179-01-A	GILLIES Delicate retractor · 1 tooth · 19 cm	1
EG-177-16-B	JOSEPH Delicate retractor · 2 teeth · 17 cm	1
EG-190-18-C	FARABEUF-BABY Retractor · double-ended · 10/12 mm · 12 cm	1
EG-189-19	WALTER Retractor · double-ended · 19 cm	1
EG-192-21-E	LANGENBECK-KOCHER Retractor · 15 × 80 mm · 21 cm	2
EG-1153-00-A	SOLZ Racket retractor · 45 × 100 mm · 12.5 cm	2
EG-1153-00-A	DEMARTEL Scalp flap forceps · 14 cm	1

Blepharoplasty Set



EG-102-07-B



EG-128-11-A



EG-147-12-A



EG-148-15-A1



EG-1102-12



EG-164-15-A1



EG-179-01-A



EG-177-16



EG-103-15T



EG-182-16-A1



EG-182-16-C2



EG-117-14-B-SU



EG-1144-13-A

Item number	Description	Quantity
EG-103-15T	Scalpel blade · fi gure 15 · sterile · packing unit 100 pieces	1
EG-102-07-B	Scalpel handle · no. 3 · 12.5 cm	1
EG-128-11-A	STEVENS Delicate scissors · straight · sharp · 11.5 cm	1
EG-128-11-B	STEVENS Delicate scissors · curved · sharp · 11.5 cm	1
EG-147-12-A	ADSON Dressing forceps · serrated · 12 cm	1
EG-148-15-A1	ADSON Dressing forceps · serrated · 12cm	1
EG-1102-12	NEIVERT Needle holder · smooth · 12.5 cm	1
EG-164-15-A1	HALSTED-MOSQUITO Hemostatic forceps · straight · 12.5 cm	1
EG-164-15-B1	HALSTED-MOSQUITO Hemostatic forceps · curved · 12.5 cm	1
EG-1144-13-A	BACKHAUS Towel clamp · 8.5 cm	4
EG-179-01-A	GILLIES Delicate retractor · 1 tooth · 19 cm	1
EG-177-16	JOSEPH Delicate retractor · 2 teeth · 17 cm	1
EG-182-16-A1	JOSEPH Delicate retractor · 2 teeth · blunt · 16 cm	1
EG-182-16-C2	DESMARRES Lid retractor · fi gure 1 · 9 × 12 mm · 13 cm	1
EG-117-14-B-SU	MAYO Dissecting scissors · supercut · straight · 14 cm	1

Plastic Surgery

Daniel Rhinoplasty Set



Item number	Description	Quantity
EG-1137-15-B	Handle for nasal rasps · double-ended · 14 cm	1
EG-1137-00	Wrench · for nasal rasp	1
EG-1137-05	HM Nasal rasps · figure 5	1
EG-1137-06	HM Nasal rasps · figure 6	1
EG-117-17-A-SU	MAYO Dissecting scissors · supercut plus · straight · 17 cm	1
EG-136-15	DANIEL Dissecting scissors · black line · straight · 15 cm	1
EG-138-15-A	JOSEPH-DANIEL Dissecting scissors · black line · curved · blunt · 15 cm	1
EG-138-15-B	JOSEPH-DANIEL Dissecting scissors · black line · curved · sharp · 15 cm	1
EG-128-09	CONVERSE-DANIEL Dissecting scissors · black line · blunt · 9.5 cm	1

Plastic Surgery

Face and Forehead Lift Instruments Sets



EG-163-55



EG-124-11-B



EG-117-14-B-SU



EG-140-20-A-SU

Item number	Description	Quantity
EG-163-55	Tissue and Intestinal Holding Forceps · 16 cm	1
EG-124-11-B	Iris scissors · supercut · curved · 12.5 cm	1
EG-117-14-B-SU	MAYO Dissecting scissors · supercut · straight · 14 cm	1
EG-140-20-A-SU	SOLZ Dissecting scissors · supercut · curved · 20 cm	1
EG-140-20-B-SU	SOLZ Dissecting scissors · supercut · curved · 20 cm	1

Plastic Surgery

Mammoplasty Instruments Set



EG-124-13-B



EG-110-04-B



EG-148-13-B



EG-152-17-C



EG-198-15-TC



EG-190-18-C



EG-192-21-E



EG-103-15T



EG-102-07-B



EG-1154-00-A



EG-1154-01-A



EG-1155-00-A



EG-1157-12



EG-106-00-A



EG-140-20-A-SU

Item number	Description	Quantity
EG-103-15T	Scalpel blade · fi gure 15 · sterile · packing unit 100 pieces	1
EG-102-07-B	Scalpel handle · no. 7 · long · 16.5 cm	1
EG-124-13-B	JABALEY Delicate scissors · standard · curved · 13 cm	1
EG-110-04-B	METZENBAUM Dissecting scissors · curved · 20 cm	1
EG-148-13-B	MICRO-ADSON Tissue forceps · 1 × 2 teeth · 12 cm	1
EG-152-17-C	GRUENWALD Bayonet forceps · 19.5 cm	1
EG-198-15	BABY CRILE-WOOD Needle holder · fi ne · 15 cm	1
EG-198-15-TC	BABY CRILE-WOOD HM Needle holder · fi ne · 15 cm	1
EG-190-18-C	FARABEUF-BABY Retractor · double-ended · 10/12 mm · 12 cm	1
EG-192-21-E	LANGENBECK-KOCHER Retractor · 15 × 80 mm · 21 cm	1
EG-1154-00-A	SOLZ Non-traumatical breast dissector · 34 cm	1
EG-1154-00-B	SOLZ Non-traumatical breast dissector · 37 cm	1
EG-1154-01-A	SOLZ Hook dissector · right angled · 36 cm	1
EG-1154-01-B	SOLZ Hook dissector · left angled · 36 cm	1
EG-106-00-B	SOLZ Areola marker · blunt · Ø 36 mm	1
EG-106-00-C	SOLZ Areola marker · blunt · Ø 40 mm	1
EG-106-00-D	SOLZ Areola marker · blunt · Ø 42 mm	1
EG-106-00-E	SOLZ Areola marker · blunt · Ø 45 mm	1
EG-1155-00-A	MARX Breast retractor · 125 × 30 mm · 27 cm	1
EG-1155-00-B	MARX Breast retractor · 140 × 30 mm · 27 cm	1
EG-157-12	Bowl for marking colour · 0.06 l · Ø 6 cm	1
EG-140-20-A-SU	SOLZ Dissecting scissors · supercut · curved · 20 cm	1
EG-140-20-B-SU	SOLZ Dissecting scissors · supercut · curved · 20 cm	1

Plastic Surgery

Daniel Gubisch Rib Harvest Set



EG-103-10T



EG-102-03-A



EG-118-12-B



EG-146-15-A



EG-147-12-B1



EG-153-15-A



EG-1100-18-A-TC



EG-186-19-A



EG-1157-00



EG-190A-17-A



EG-190A-17-B



EG-190A-17-C



EG-178-17-A



EG-190A-18-A



EG-190A-18-B

Item number	Description	Quantity
EG-103-10T	Scalpel blade · figure 10 · sterile · packing unit 100 pieces	1
EG-102-03-A	Scalpel handle · no. 3 · standard · 12.5 cm	1
EG-118-12-B	Operating scissors · straight · sharp/blunt · 14.5 cm	1
EG-146-15-A	Tissue forceps · straight · slim · 1 x 2 teeth · 14.5 cm	1
EG-147-12-B1	ADSON-BROWN Tissue forceps · straight · 7 x 7 teeth · 12 cm	1
EG-153-15-A	Russian tissue forceps · 15 cm	1
EG-1100-18-A-TC	MAYO-HEGAR HM Needle holder · 18 cm	1
EG-186-19-A	STRANDELL-STILLE Retractor · 6 x 15 mm · 17 cm	2
EG-190A-18-A	PARKER-LANGENBECK (US AEGY) Retractor · double-ended · 21 cm · set/2	1
EG-190A-18-B	PARKER-LANGENBECK (US AEGY) Retractor · double-ended · serrated · 21 cm · set/2	1
EG-190A-17-A	DANIEL-GUBISCH Raspatory · 6 mm · sharp · slight curved · 17.5 cm	1
EG-190A-17-B	DANIEL-GUBISCH Raspatory · 6 mm · sharp · medium curved · 17 cm	1
EG-190A-17-C	DANIEL-GUBISCH Raspatory · 6 mm · sharp · strong curved · 16 cm	1
EG-157-00	Round bowl · Ø 60 mm · height 30 mm · 60 ml	1
EG-157-01	Round bowl · Ø 80 mm · height 40 mm · 160 ml	1
EG-157-02	Round bowl · Ø 110 mm · height 55 mm · 400 ml	1
EG-178-17-A	DANIEL-GUBISCH Rib raspatory · right · 5 mm · sharp · 17 cm	1
EG-178-17-B	DANIEL-GUBISCH Rib raspatory · left · 5 mm · sharp · 17 cm	1

Plastic Surgery

Nagata Harvesting of Coastal Cartilages



Item number	Description	Quantity
EG-146-15-B	McINDOE Dressing forceps · 15 cm	1
EG-146-15-A	GILLIES Tissue forceps · 1 × 2 teeth · 15 cm	1
EG-186-16-B	SENN-MILLER Delicate retractor · double-ended · blunt · 16 cm	2
EG-181-17-B	JACKSON Delicate retractor · double-ended · blunt · 18 cm	2
EG-177-15-B	JOSEPH Delicate retractor · 16 cm	1
EG-192-21-B	LANGENBECK Retractor · 10 × 40 mm · 21 cm	2
EG-179-24	COHEN Elevator · double-ended · 5 mm · 24 cm	1
EG-182-20	PENNINGTON Septum elevator · double-ended · 20 cm	1
EG-178-18	DINGMAN Raspatory · double-ended · 18 cm	1
EG-117-14-B-SU	MAYO Delicate scissors · supercut · curved · 14 cm	1

Plastic Surgery

Daniel Gubisch Rib Harvesting Set



EG-153-15-A **EG-186-19-A** **EG-190A-18-A** **EG-190A-18-B** **EG-190A-17-A** **EG-190A-17-B** **EG-190A-17-C** **EG-178-17-A** **EG-181-21**

Item number	Description	Quantity
EG-153-15-A	Russian tissue forceps · 15 cm	1
EG-186-19-A	STRANDELL-STILLE Retractor · 6 x 15 mm · 17 cm	2
EG-190A-18-A	PARKER-LANGENBECK (US AEGY) Retractor · double-ended · 21 cm · set/2	1
EG-190A-18-B	PARKER-LANGENBECK (US AEGY) Retractor · double-ended · serrated · 21 cm · set/2	1
EG-190A-17-A	DANIEL-GUBISCH Raspatory · 6 mm · sharp · slight curved · 17.5 cm	1
EG-190A-17-B	DANIEL-GUBISCH Raspatory · 6 mm · sharp · medium curved · 17 cm	1
EG-190A-17-C	DANIEL-GUBISCH Raspatory · 6 mm · sharp · strong curved · 16 cm	1
EG-178-17-A	DANIEL-GUBISCH Rib raspatory · right · 5 mm · sharp · 17 cm	1
EG-181-21	DANIEL-GUBISCH Raspatory · double-ended · 4 mm · sharp/abrasive · 21.5 cm	1

Plastic Surgery

Abdominoplasty Set



EG-103-15T

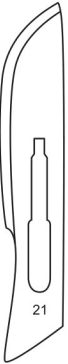

EG-103-21T



EG-102-04



EG-102-07-B



EG-120-13



EG-148-15-A1



EG-147-12-C1



EG-140-20-A-SU



EG-151-21-A



EG-197-12



EG-1100-16-A-TC



EG-1156-00



EG-1144-13-A



EG-177-16-D



EG-190-18-C



EG-1156-01



EG-128-11-B1-SU



EG-117-14-B-SU



EG-130-23-B-SU

Item number	Description	Quantity
EG-103-15T	Scalpel blade · figure 15 · sterile · packing unit 100 pieces	1
EG-103-21T	Scalpel blade · figure 21 · sterile · packing unit 100 pieces	1
EG-102-07-B	Scalpel handle · no. 7 · long · 16.5 cm	1
EG-102-04	Scalpel handle · no. 4L · 21 cm	1
EG-120-13	RAGNELL (KILNER) Delicate dissecting scissors · curved · 13 cm	1
EG-148-15-A1	ADSON Tissue forceps · 1 × 2 teeth · 15 cm	1
EG-147-12-C1	ADSON-BROWN Tissue forceps · 9 × 9 teeth · 12 cm	1
EG-151-21-A	POTTS-SMITH Tissue forceps · 1 × 2 teeth · 21 cm	1
EG-151-25-A	ADSON Tissue forceps · 1 × 2 teeth · 25 cm	1
EG-197-12	WRIGHT (DERF) HM Needle holder · fine · 12.5 cm	2
EG-1100-16-A-TC	MAYO-HEGAR HM Needle holder · fine · 15 cm	2
EG-1100-24-A-TC	MAYO-HEGAR HM Needle holder · fine · 23 cm	2
EG-1144-13-A	BACKHAUS Towel clamp · 8.5 cm	6
EG-177-16-D	JOSEPH Delicate retractor · 2 teeth · 10 mm · sharp · 17 cm	2
EG-190-18-C	FARABEUF-BABY Retractor · double-ended · 10/12 mm · 12 cm	1
EG-1156-00	SALDANHA-SOLZ Abdominal retractor · 37 cm	1
EG-1156-01	SOLZ Navel marker · dismantable · 29 cm	1
EG-128-11-B1-SU	STEVENS Delicate scissors · supercut · curved · 11.5 cm	1
EG-117-14-B-SU	MAYO Dissecting scissors · supercut · straight · 14 cm	1
EG-130-23-B-SU	GORNEY Dissecting scissors · supercut · curved · 23 cm	1
EG-140-20-A-SU	SOLZ Dissecting scissors · supercut · curved · 20 cm	1
EG-140-20-B-SU	SOLZ Dissecting scissors · supercut · curved · 20 cm	1

Plastic Surgery

Nagata Articular Reconstruction with Coastal Cartilages



EG-147-12-A



EG-148-15-A1



EG-146-15-A



EG-146-15-B



EG-1104-11



EG-199-17A-TC



EG-139-12



EG-169-12-A



EG-164-15-B1

Item number	Description	Quantity
EG-147-12-A	ADSON Dressing forceps · serrated · 12 cm	2
EG-148-15-A1	ADSON Tissue forceps · 1 × 2 teeth · 12 cm	2
EG-146-15-B	McINDOE Dressing forceps · serrated · 15 cm	1
EG-146-15-A	GILLIES Tissue forceps · 1 × 2 teeth · 15 cm	1
EG-1104-11	NAGATA HM Needle holder · smooth · 11.5 cm	2
EG-199-17A-TC	MATHIEU HM Needle holder · regular · 17 cm	2
EG-139-12	UNIVERSAL HM Wire cutting scissors · serrated cutting edge · 12 cm	2
EG-169-12-A	NIRO HM Wire twisting forceps · 15 cm	2
EG-164-15-B1	HALSTED-MOSQUITO Hemostatic forceps · curved · 12.5 cm	2

Plastic Surgery

Nagata Articular Reconstruction with Coastal Cartilages



EG-1124-16



EG-1125-00



EG-178-00-A



EG-178-00-B



EG-125-10-A

Item number	Description	Quantity
EG-1124-16	NAGATA Septum elevator · blunt · double-ended · 16 cm	1
EG-1125-00	NAGATA Septum elevator · blunt · double-ended · 17 cm	1
EG-178-00-A	DOYEN Rip raspatory · right · 17 cm	1
EG-178-00-B	DOYEN Rip raspatory · left · 17 cm	1
EG-125-10-A	Delicate dissecting scissors · supercut · straight · 12 cm	2

Plastic Surgery

Kasten Preparation of Skin Graft



EG-145-15-A EG-146-15-A



EG-1100-24-A-TC



EG-1103-18-A-TC



EG-164-14-B1

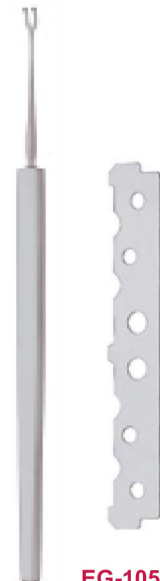

EG-181-13-B

EG-105-03



EG-125-10-B-SU



EG-122-18-A-SU

Item number	Description	Quantity
EG-145-15-A	Dressing forceps · 14.5 cm	1
EG-146-15-A	Tissue forceps · 1 × 2 teeth · 14.5 cm	1
EG-1100-24-A-TC	MAYO-HEGAR HM Needle holder · noEGal · 20 cm	1
EG-1103-18-A-TC	MICRO-SLIM HM Needle holder · fi ne · 18 cm	1
EG-164-14-B1	HALSTED-MOSQUITO Hemostatic forceps · curved · 14 cm	4
EG-181-13-B	GUTHRIE Delicate retractor · 2 teeth · sharp · 13 cm	1
EG-105-03	Spare blade · packing unit 10 pieces · 6.5 cm	1
EG-125-10-B-SU	Delicate dissecting scissors · supercut plus · curved · 12 cm	1
EG-122-18-A-SU	METZENBAUM Dissecting scissors · supercut plus · curved · 18 cm	1

Plastic Surgery

Checking Sets

Wir bieten Krankenhäusern den Service von Siebsichtungen an. Leistungsumfang der Siebsichtung:

- Erfassung des gesamten Instrumentariums nach Quantität und Wert
- Standardisierung der Siebe respektive Ergänzung fehlender Instrumente
- Austausch oder Reparatur defekter Instrumente
- Erstellung von Übersichts- und Packlisten

the set checking includes:

We offer a set checking service for hospitals. Our performance of

- Record of all instruments according to quantity and value
- Standardization of the sets and completion of missing instruments respectively
- Exchange or repair of defective instruments
- Compilation of summary or packing lists

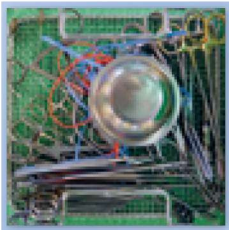

Nosotros ofrecemos para hospitales un servicio de revisión del instrumental quirúrgico. Contenido del servicio:

- Registro de todos los instrumentos según cantidad y valor
- Estandarizar los set instrumentales y completar los instrumentos faltantes
- Cambio o reparación de instrumentos defectos
- Elaboración de listas de contenido y empaque



Nous offrons aux hôpitaux un service de contrôle des boîtes. Le contrôle des boîtes contient:

- Enregistrement et chiffrage de l'instrumentation complète selon quantité et valeur
- Standardisation des boîtes ou complément d'instruments manquants
- Echange ou réparation des instruments défectueux
- Mise en place de listes de contenu et d'emballage

Offriamo un servizio di verifica dei set chirurgici per gli ospedali. Interventi nella verifica dei set chirurgici:

- Raccolta dello strumentario secondo quantità e valore
- Standardizzazione dei set attraverso l'aggiunta di strumenti mancanti
- Sostituzione o riparazione degli strumenti difettosi
- Elaborazione di un elenco del contenuto e dell'imballaggio