

LAMINECTOMY RONGEURS



Laminektomieztangen
Pinzas Para Laminectomía

Pinces Pour Laminectomie
Pinze Per Laminectomia

120 mm

AE-1264
3.0 mm

AE-1265
3.6 mm

AE-1266
4.2 mm

AE-1267
4.8 mm

AE-1268
5.8 mm

WEIL - BLAKESLEY

AE-1269
small
4 x 9 mm bite

AE-1270
Medium
5 x 10 mm bite

AE-1271
large
6 x 11 mm bite

WILDE INTERVERTEBRAL DISC RONGEUR
12.5 cm, 5" shaft
fenestrated jaws straight

DECKER INTERVERTEBRAL DISC RONGEUR
AE-1272
15 cm, 6" shaft
2 x 6 mm bite straight

Working length 14 mm

MICRO GRASPING FORCEPS
AE-1273
serrated, straight

MICRO ALLIGATOR SCISSORS
AE-1274
straight

AE-1275
Ø1.0 mm
Straight

AE-1276
Ø2.0 mm
Straight

AE-1277
Ø3.0 mm
Straight

AE-1278
Ø1.0 mm
angled up

AE-1279
Ø2.0 mm
curved to right

AE-1280
Ø3.0 mm
curved to left

MIRCO CUP FORCEPS

LAMINECTOMY RONGEURS

Laminektomieztangen
Pinzas Para Laminectomía

Pinces Pour Laminectomie
Pinze Per Laminectomia



AE-1281
Grasping Forceps
Ø 3 mm



AE-1282
Cup Forceps
Ø 2 mm



AE-1283
Alligator Scissors
Ø 2 mm

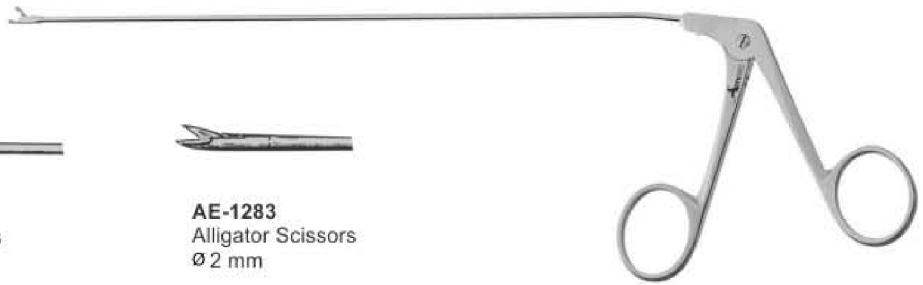

MICRO ALLIGATOR FORCEPS
with tubular shaft
18 cm, 7"

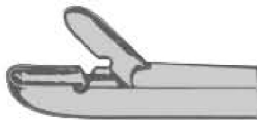
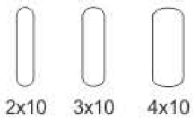

Straight Shaft	180 mm
Bite 2 x 10 mm	AE-1284
Bite 3 x 10 mm	AE-1285
Bite 4 x 10 mm	AE-1286



Angled - up Shaft	180 mm
Bite 2 x 10 mm	AE-1287
Bite 3 x 10 mm	AE-1288
Bite 4 x 10 mm	AE-1289

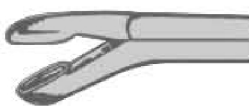

Angled - down Shaft	180 mm
Bite 2 x 10 mm	AE-1290
Bite 3 x 10 mm	AE-1291
Bite 4 x 10 mm	AE-1292

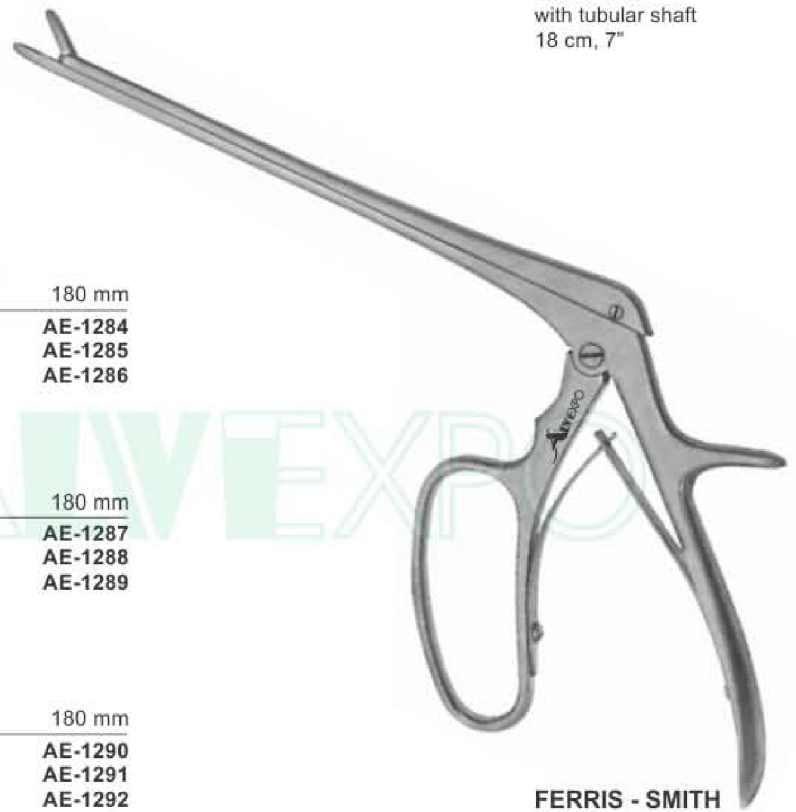

FERRIS - SMITH

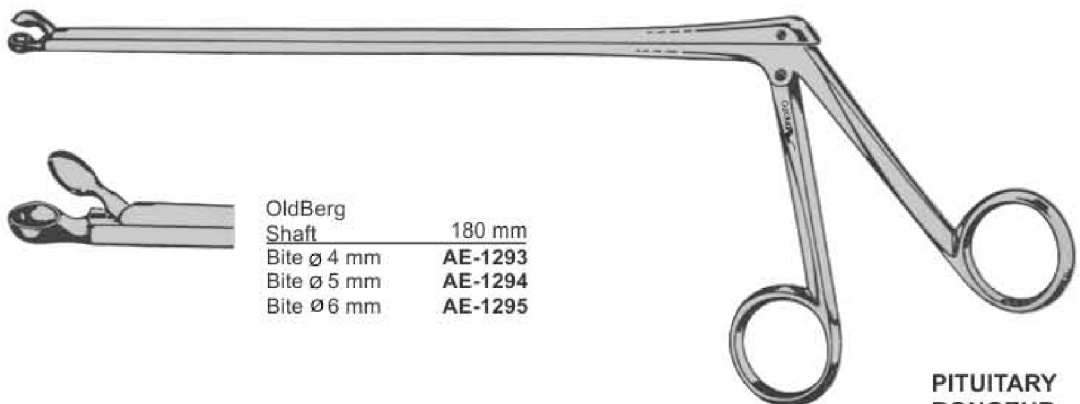

OldBerg Shaft	180 mm
Bite Ø 4 mm	AE-1293
Bite Ø 5 mm	AE-1294
Bite Ø 6 mm	AE-1295

PITUITARY RONGEUR

LAMINECTOMY PUNCHES



Laminektomiestanzen
Pinzas Cortantes Para Laminectomía

Pinces Emporte-pièces à Laminectomie
Pinze Taglienti Per Laminectomia

2.0 mm 3.0 mm 3.5 mm

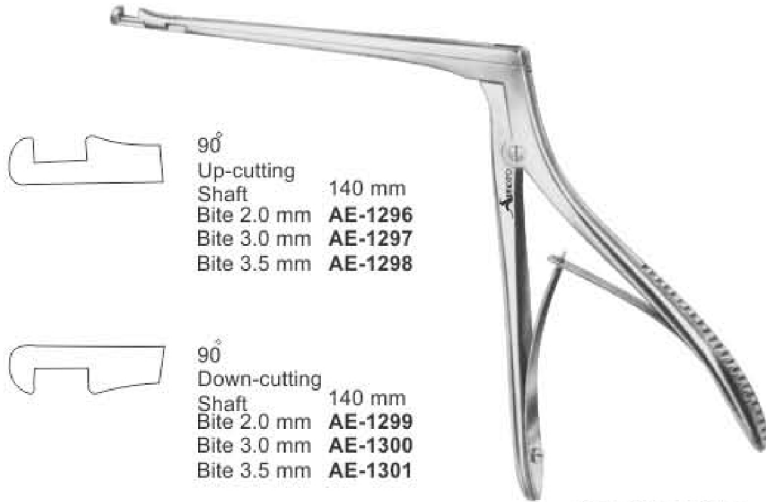

90°
Up-cutting
Shaft 140 mm
Bite 2.0 mm AE-1296
Bite 3.0 mm AE-1297
Bite 3.5 mm AE-1298

90°
Down-cutting
Shaft 140 mm
Bite 2.0 mm AE-1299
Bite 3.0 mm AE-1300
Bite 3.5 mm AE-1301

HAJEK-KOFLER

1.0 mm
2.5 mm
4.0 mm

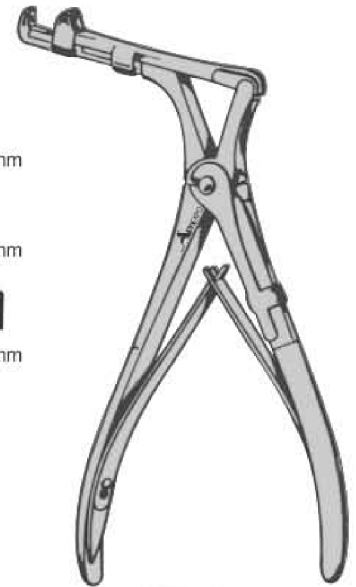

CITELLI
AE-1302 1.0 mm
AE-1303 2.5 mm
AE-1304 4.0 mm

160 mm, 6 1/4"



HAJEK-KOFLER
AE-1305
3.5 mm

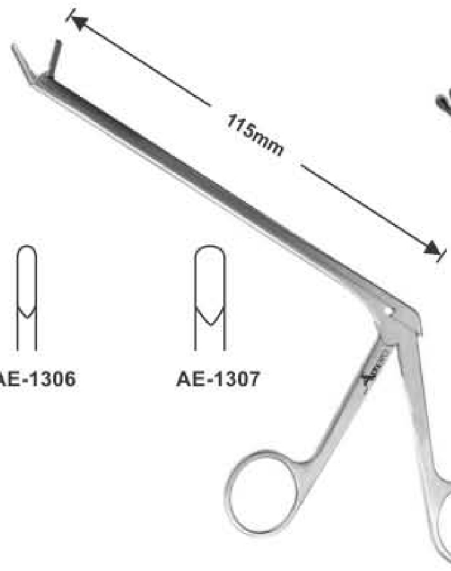

AE-1306
AE-1307

SPURLING-LOVE
AE-1306 28cm
AE-1307 28cm

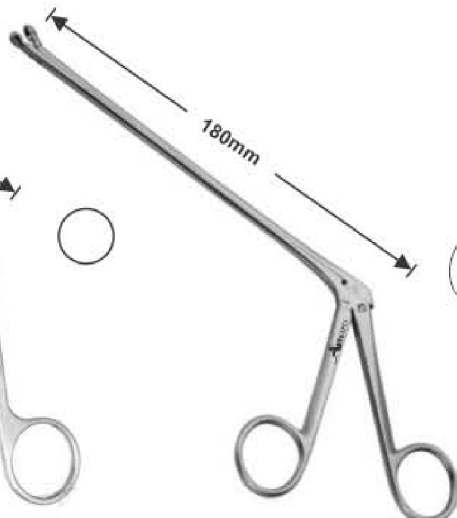

OLDBERG
AE-1308 25cm

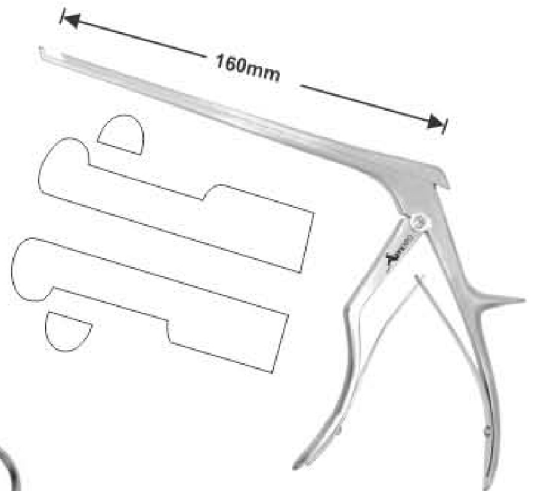

COLCLOUGH
AE-1309 27cm UP CUTTING
AE-1310 27cm DOWN CUTTING





LOVE-KERRISON
LAMINECTOMY PUNCH





Forward 90° Regular Footplate

	2 mm bite forward	
	AE-1311	150 mm
	AE-1312	200 mm

	3 mm bite forward	
	AE-1313	150 mm
	AE-1314	200 mm

	4 mm bite forward	
	AE-1315	150 mm
	AE-1316	200 mm

	5 mm bite forward	
	AE-1317	150 mm
	AE-1318	200 mm

	6 mm bite forward	
	AE-1319	150 mm
	AE-1320	200 mm



Up 40° Regular footplate

	2 mm bite up	
	AE-1321	150 mm
	AE-1322	200 mm

	3 mm bite up	
	AE-1323	150 mm
	AE-1324	200 mm

	4 mm bite up	
	AE-1325	150 mm
	AE-1326	200 mm

	5 mm bite up	
	AE-1327	150 mm
	AE-1328	200 mm

	6 mm bite up	
	AE-1329	200 mm



Down 90° Regular footplate

	3 mm bite down	
	AE-1330	150 mm
	AE-1331	200 mm

	4 mm bite down	
	AE-1332	150 mm
	AE-1333	200 mm

	5 mm bite down	
	AE-1334	150 mm
	AE-1335	200 mm

ALLIGATOR EAR FORCEPS



Alligator-ohrfaßzangen
Pincas crocodiles à oreilles

Pinze alligatore per orecchi
Pinzas de boca de cocodrilo para el oído



HARTMANN-WULLSTEIN
AE-1336



HARTMANN-WULLSTEIN
AE-1337



HARTMANN
AE-1338
AE-1339



HARTMANN
AE-1340
AE-1341



HARTMANN-NOYES
AE-1342



DUCKBILL
AE-1343



WEINGÄRTNER
AE-1344



HARTMANN
AE-1345 = 2.0 mm
AE-1346 = 2.5 mm
AE-1347 = 3.0 mm



HARTMANN
AE-1348 = 2.0 mm
AE-1349 = 2.5 mm
AE-1350 = 3.0 mm



STRÜMPEL
AE-1351



HARTMAN
AE-1352



HARTMANN
AE-1353



HARTMANN-HOFFMANN
AE-1354

NASAL SPECULUM

Nasenspekula
Especulos Nasaes

Spéculums Nasaux
Specoli Nasali



VIENNA NASAL SPECULUM
AE-1355 - Infant
AE-1356 - Child
AE-1357 - Adult
14 cm, 5 1/2"

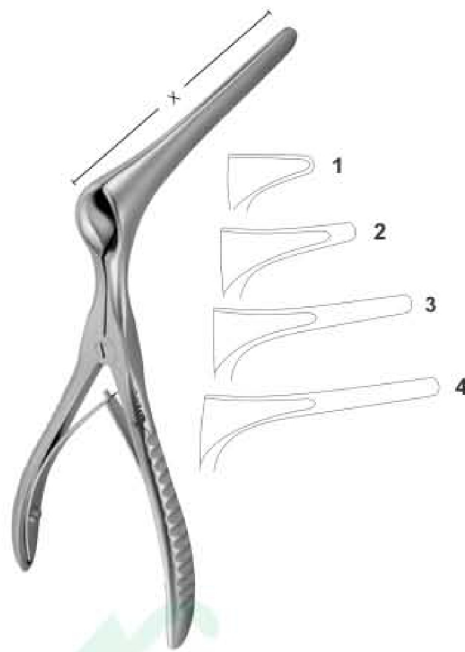

KILLIAN NASAL SPECULUM
AE-1358 35 mm 2" Small blade
AE-1359 50 mm 3" Medium blade
AE-1360 75 mm
AE-1361 90 mm
13 cm, 5 1/4"



THUDICHUM (Golfsmith)



AE-1362
6.5 cm, 2 1/2"

AE-1363
6.5 cm, 2 1/2"

AE-1364
6.5 cm, 2 1/2"

AE-1365
6.5 cm, 2 1/2"

AE-1366
6.5 cm, 2 1/2"

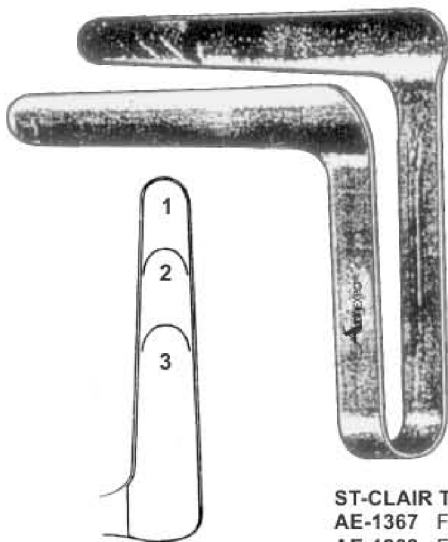

ST-CLAIR THOMSON
AE-1367 Fig 1
AE-1368 Fig 2
AE-1369 Fig 3

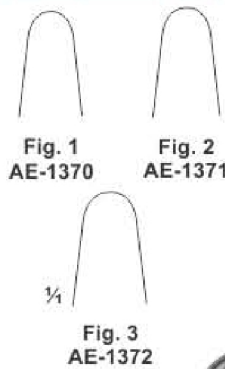

Fig. 1
AE-1370

Fig. 2
AE-1371

1/4
Fig. 3
AE-1372



VOLTOLINI (Duplay)



YANKAUER
AE-1373
19cm

SEPTUM FORCEPS, TONSIL PUNCHES



Nasendpolyenzangen, Tonsillenzangen
Pinzas Para Pólipos Nasaes, Pinzas Para Amígdalas

Pinces À Polypos Nasaux, Pinces Pour Amygdalas
Pinze Per Polipi Nasali, Pinze Per Tonsille

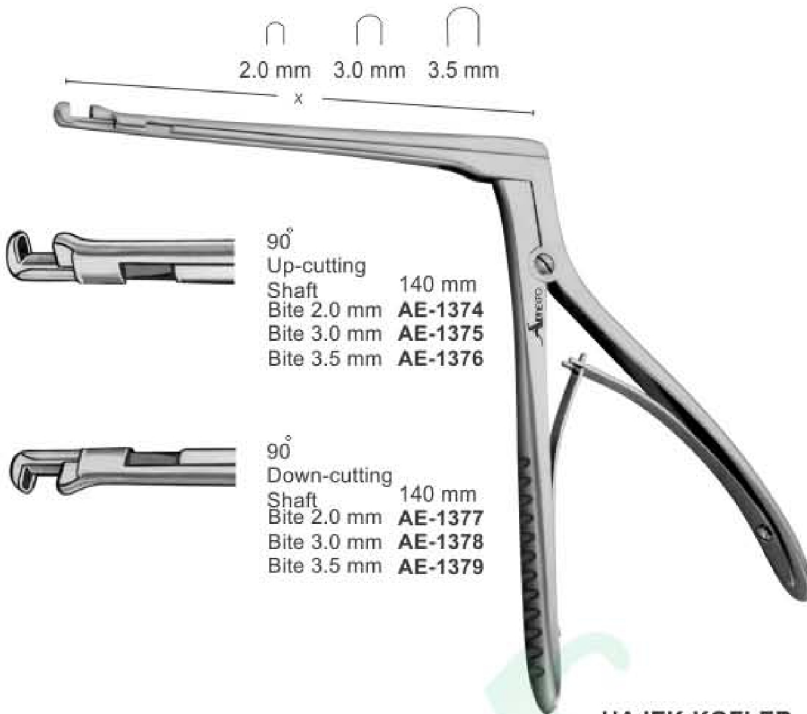

¼
AE-1380
up cutting
3 x 3 mm

AE-1381
up cutting
4 x 4 mm

AE-1382
up cutting
5 x 5 mm

AE-1383
up cutting
6 x 6 mm



KERRISON
9 cm, 3 ½"

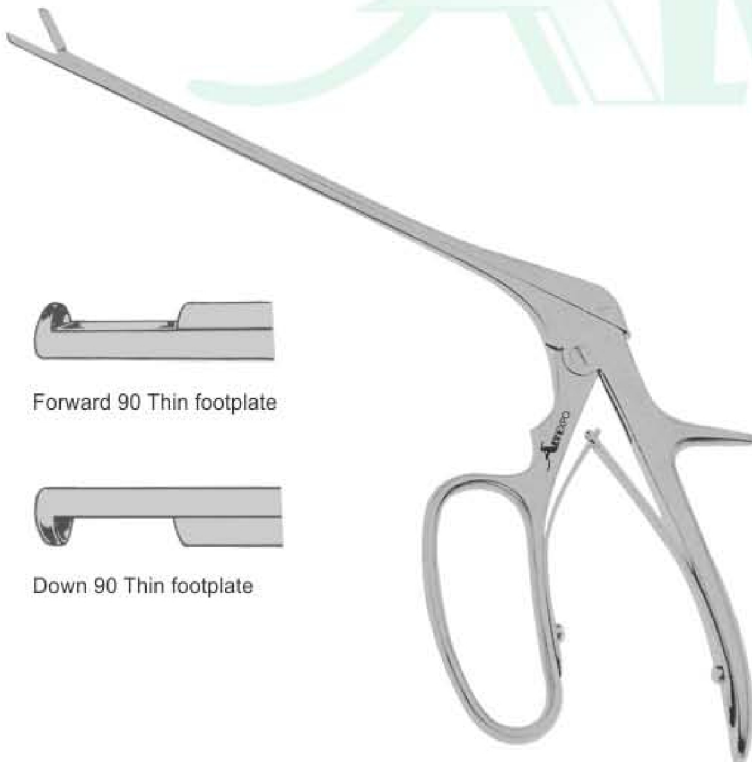

FERRIS - SMITH
AE-1384

AE-1385
19 cm, 7 ½"
Double Action
5 x 15mm tip



JANSEN-MIDDLETON

INTESTINAL & TISSUE GRASPING FORCEPS

Darm-und Gewebefasszangen
Pinzas Para Intestinos y Tejidos

Pinces Pour Saisir Intestins et Tissus
Pinze Per Afferrare Intestino e Tessuti



ALLIS
AE-1386
20 cm, 8"

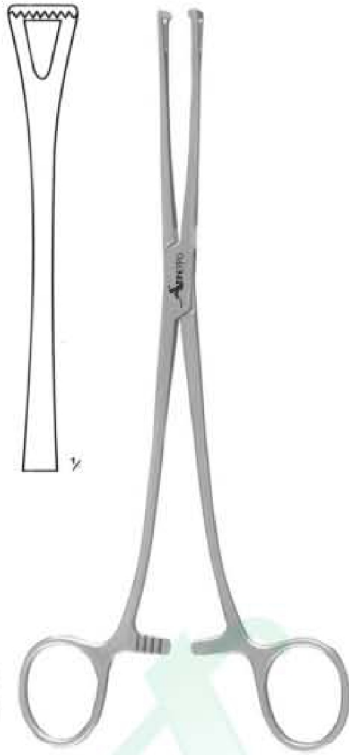

LOCKWOOD
AE-1387
20 cm, 8"



ALLIS ADAIR
AE-1388
15.5 cm



LOCKWOOD
AE-1389
20cm 8"



JUDD-ALLIS
AE-1390
3 x 4 teeth
19.5 cm, 7 3/4"



LITTLEWOOD
AE-1391
19 cm, 7 1/2"



STILLE
AE-1392
20 cm, 8"



LANE
AE-1393 12.5 cm
AE-1394 15.0 cm
AE-1395 19.0 cm

POLYOUS GRASPING FORCEPS, ANASTOMOSIS



Polypenfasszange, Darm-anastomosenklemmen

Pince Pour Saisir Polypes, Pincés-clamps Pour Anastomose Intestinale

Pinza Para Coger Pólipos, Clamps Para Anastomosis Intestinales

Pinze Per Afferrare Polipi, Pinze Per Anastomosi Intestinali

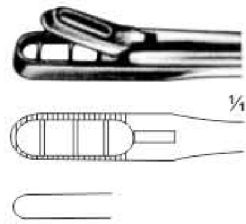
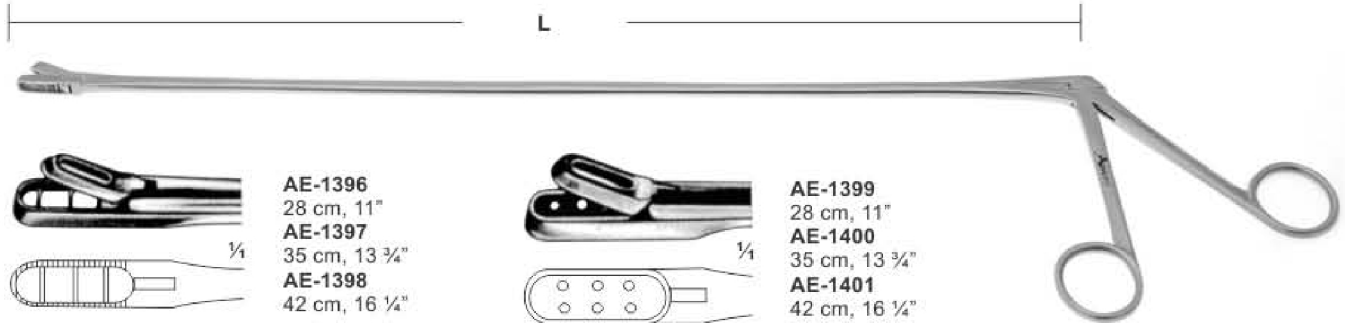

AE-1396
28 cm, 11"
AE-1397
35 cm, 13 3/4"
AE-1398
42 cm, 16 1/4"

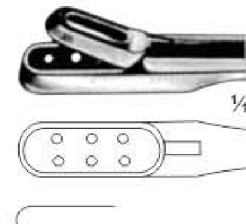

AE-1399
28 cm, 11"
AE-1400
35 cm, 13 3/4"
AE-1401
42 cm, 16 1/4"

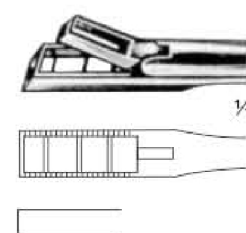

AE-1402
28 cm, 11"
AE-1403
35 cm, 13 3/4"
AE-1404
42 cm, 16 1/4"

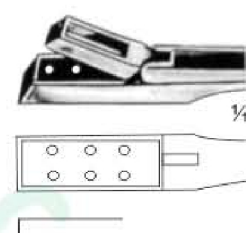

AE-1405
28 cm, 11"
AE-1406
35 cm, 13 3/4"
AE-1407
42 cm, 16 1/4"

YEOMANN

PILE FORCEPS

COTTON CARRIER

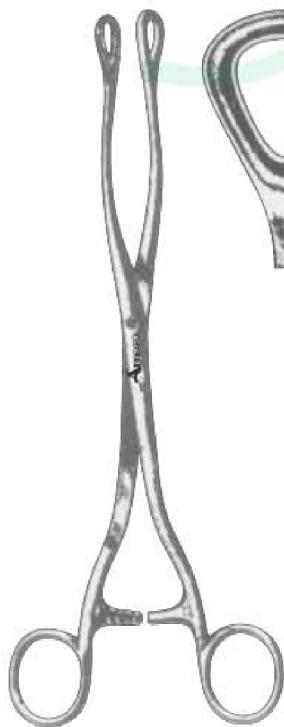

LURE
AE-1408 24.5cm

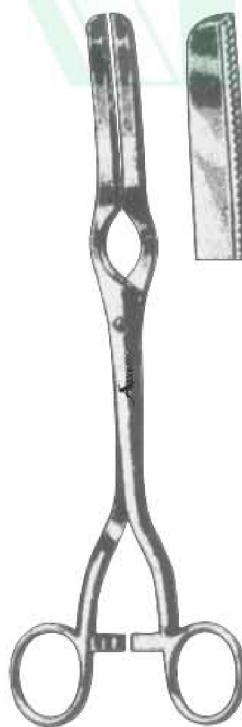

JARVIS
AE-1409 23cm

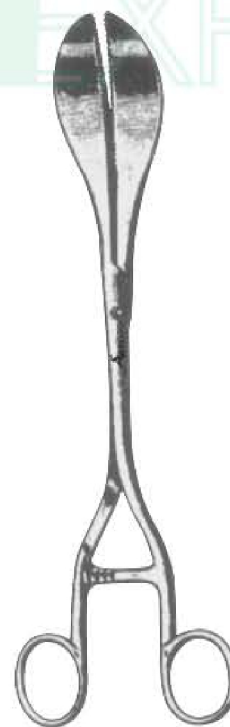

LANGENBECK
AE-1410 45cm



AE-1411 45cm