

Plastic Surgery

Trachea and Nose Retractors



1:2
Kilner

150 mm – 6"
EG-176-15



1:2
Gillies



1:1



1:1

	Fig. 1	Fig. 2
180 mm – 7"	EG-176-18-A	EG-176-18-B



150 mm	EG-176-01	Single Hook
150 mm	EG-176-02	2 mm Single Hook
150 mm	EG-176-03	5 mm Double Hook
150 mm	EG-176-04	8 mm Double Hook
150 mm	EG-176-05	11 mm Double Hook
150 mm	EG-176-06	13 mm Double Hook with Ball Ends

Tebbetts Self Retaining Skin Hook



1:2

Lange
220 mm – 8³/₄"
EG-176-22



1:2
Cottle

160 mm – 6¹/₄"
EG-176-16



1:2
Fomon

170 mm – 6³/₄"
EG-176-17



150 mm – 6"
EG-176-00

3 mm



Plastic Surgery

Trachea and Nose Retractors



Cottle

150 mm – 6 "



1:1

EG-177-15-A



1:1

EG-177-15-B



1:1

EG-177-15-C



Joseph

150 mm – 6 "

EG-177-15-D



Mandibular

185 mm

EG-177-18-A



Joseph

160 mm – 6 1/4 "

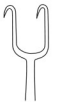

2 mm

EG-177-16-A



5 mm

EG-177-16-B



7 mm

EG-177-16-C



10 mm

EG-177-16-D



Crile 1:2

200 mm – 8 "



1:1

Fig. 1

EG-177-20-A

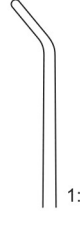

1:1

Fig. 2

EG-177-20-B

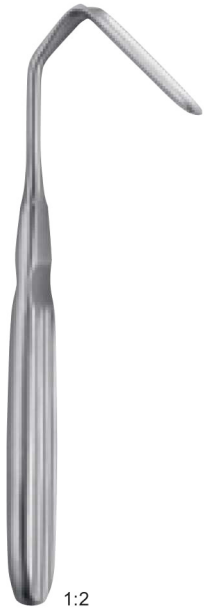

1:2
Aufricht
190 mm – 7½"
EG-178-19-A



1:2
Aufricht
190 mm – 7½"
EG-178-19-B



1:2
Converse
120 mm – 4"
EG-178-12



Aufricht
EG-178-13

Nasenhaken
Nasal hook
Crochet pour le nez
Gancho para la nariz
Uncino nasale

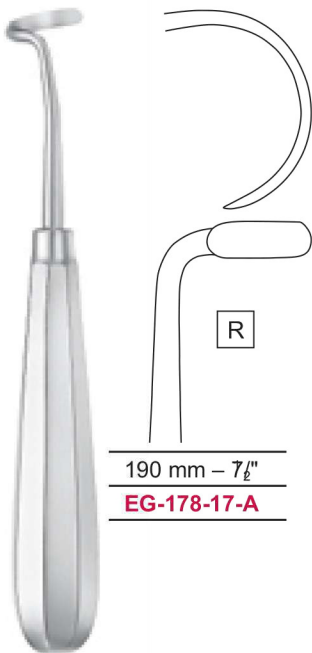

190 mm – 7½"
EG-178-17-A

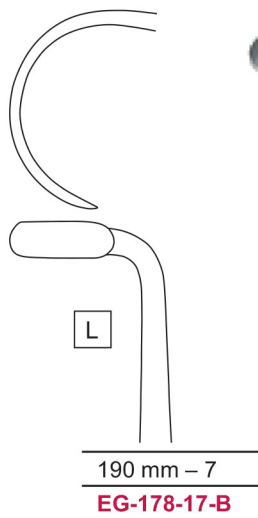

190 mm – 7"
EG-178-17-B



1/2"

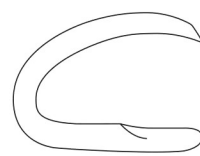

170 mm
EG-178-00-A

R

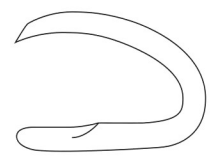

170 mm
EG-178-00-B

L

Plastic Surgery

Trachea and Nose Retractors

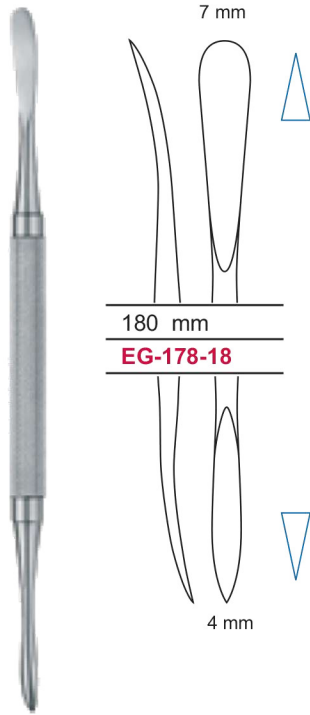

180 mm
EG-178-18

Dingman



1:2
Kilner
100 mm – 4 "
EG-179-10



1:2
Martinez Kilner
110 mm – 4 1/4 "
EG-179-11
6 mm



1:2
Cottle
EG-179-12

Daumenhaken
Thumb hook
Crochet pour le doigt
Gancho para el dedo
Uncino da fi ssare sul pollice



Gillies	3 mm	5 mm
	190 mm	190 mm
	EG-179-01-A	EG-179-01-B



Cohen

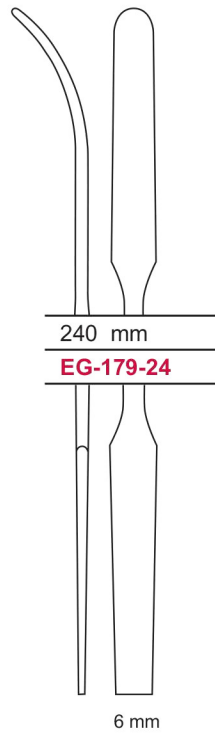

240 mm
EG-179-24



130 mm
EG-179-13



C
Cottle-Neivert
200 mm – 8 "
EG-180-20



1:2
Fomon
160 mm – 6 1/4 "
EG-180-16-A



1:2
Cottle
150 mm – 6 1/4 "

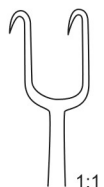

1:1
EG-180-15-A



1:1
EG-180-15-B

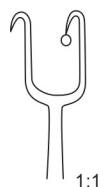

1:1
EG-180-15-C

1:2

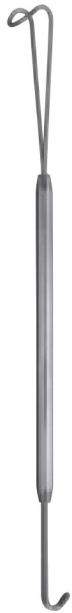

1:2
Neivert
160 mm – 6 1/4 "
EG-180-16-B



1:2
Cottle
150 mm – 6 " **EG-180-15-A1** **EG-180-15-B1**



1:2



1:2
Iterson
160 mm – 6



1:1
EG-180-16-C

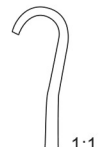

1:1
EG-180-16-D

Plastic Surgery

Trachea Retractors



1:2

Jackson

150 mm – 6"

EG-181-15



1:2

Lukens

170 mm – 6²/₃"

EG-181-17-A



1:2

Jackson

170 mm – 6²/₃"

EG-181-17-B



1,5 × 2 mm



2 × 3 mm



Guthre

130 mm – 5¹/₈"

EG-181-13-A

130 mm – 5¹/₈"

EG-181-13-B



1:2

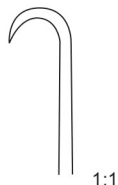

1:1

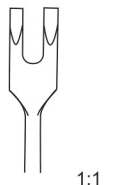

1:1

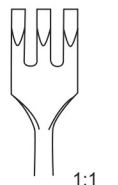

1:1

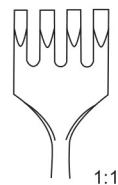

1:1

160 mm – 6¹/₄"

EG-181-16-A

EG-181-16-B

EG-181-16-C

EG-181-16-D

scharf
sharp

pointu
agudo
acuto

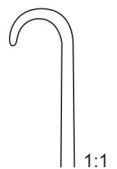

1:1

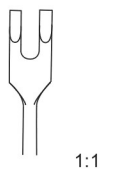

1:1

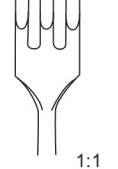

1:1

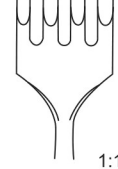

1:1

160 mm – 6¹/₄"

EG-181-16-A1

EG-181-16-B1

EG-181-16-C1

EG-181-16-D1

stumpf
blunt
mousse
romo



Daniel-Gubisch

215 mm

EG-181-21

Trachea Retractors

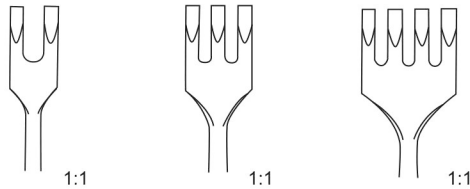

160 mm – 6 $\frac{1}{4}$ "	EG-182-16-A	EG-182-16-B	EG-182-16-C
----------------------------	--------------------	--------------------	--------------------

fl exibel, scharf
fl exible, sharp
 fl exible, pointu
fl exible, agudo
 fl essibile, acuto

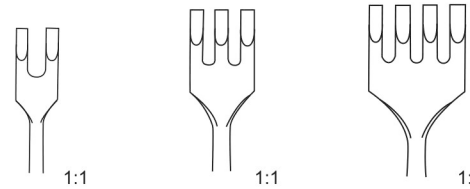

160 mm – 6 $\frac{1}{4}$ "	EG-182-16-A1	EG-182-16-B1	EG-182-16-C1
----------------------------	---------------------	---------------------	---------------------

fl exibel, stumpf
fl exible, blunt
 fl exible, mousse
fl exible, romo
 fl essibile, smusso



Desmarres	x = 8 mm	x = 10 mm	x = 12 mm
160 mm – 6 $\frac{1}{4}$ "	EG-182-16-A2	EG-182-16-B2	EG-182-16-C2

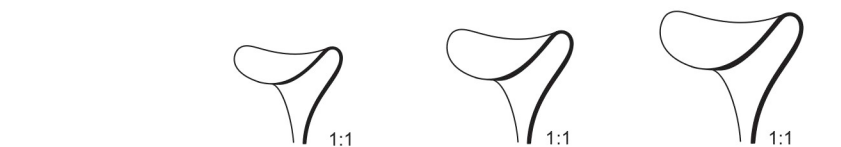

	x = 14 mm	x = 16 mm	x = 18 mm
160 mm – 6 $\frac{1}{4}$ "	EG-182-16-A3	EG-182-16-B3	EG-182-16-C3

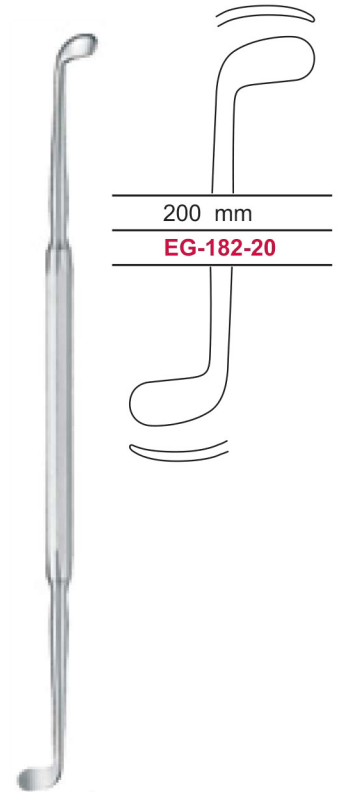

200 mm
EG-182-20

Pennington



(Rollet)
 Knapp

160 mm – 6 $\frac{1}{4}$ "
EG-182-16-A0
 fl exibel, scharf
fl exible, sharp

Mamoplasty Retractors

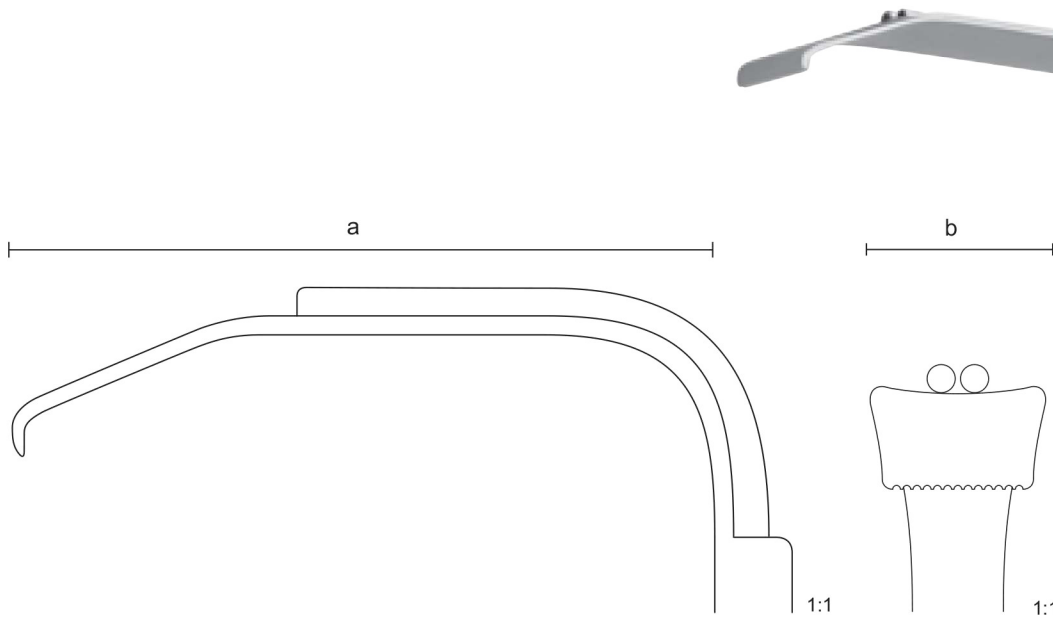

a	b	185 mm – 7 $\frac{1}{4}$ "	185 mm – 7 $\frac{1}{4}$ "
90 mm	24 mm	EG-183-09-A	EG-183-09-B
115 mm	24 mm	EG-183-11-A	EG-183-11-B
150 mm	25 mm	EG-183-25-A	EG-183-25-B
150 mm	36 mm	EG-183-36-A	EG-183-36-B
190 mm	30 mm	EG-183-19-A	EG-183-19-B

gezahnt und Kaltlichtbeleuchtung
toothed with fiber optic illumination

dentelée avec illumination à lumière froide
dentada con iluminación de luz fría
dentata con illuminazione a luce fredda

mit Spühlrohr
with irrigation tube

avec tube de lavage
con tubo lavador
con tubo di lavaggio

ohne Spühlrohr
without irrigation tube

sans tube de lavage
sin tubo lavador
senza tubo di lavaggio

a	b	185 mm – 7 $\frac{1}{4}$ "	185 mm – 7 $\frac{1}{4}$ "
90 mm	24 mm	EG-183-09-A1	EG-183-09-B1
115 mm	24 mm	EG-183-11-A1	EG-183-11-B1
150 mm	25 mm	EG-183-25-A1	EG-183-25-B1
150 mm	36 mm	EG-183-36-A1	EG-183-36-B1
190 mm	30 mm	EG-183-19-A1	EG-183-19-B1

ohne Zähne mit Kaltlichtbeleuchtung
non-toothed with fiber optic illumination

sans denture avec illumination à lumière froide
sin dentada con iluminación de luz fría
no dentata con illuminazione a luce fredda

mit Spühlrohr
with irrigation tube

avec tube de lavage
con tubo lavador
con tubo di lavaggio

ohne Spühlrohr
without irrigation tube

sans tube de lavage
sin tubo lavador
senza tubo di lavaggio



Mamaplasty Retractors

EG-184-00

Ferreira

a	b	185mm – 7 $\frac{1}{4}$ "	
90mm	24 mm	EG-184-09-A	EG-184-09-B
115mm	24 mm	EG-184-11-A	EG-184-11-B
150mm	25 mm	EG-184-25-A	EG-184-25-B
150 mm	36 mm	EG-184-15-A	EG-184-15-B
190mm	30 mm	EG-184-19-A	EG-184-19-B

MacCollum -
Dingman

315mm – 12 $\frac{1}{2}$ "

EG-184-31

1:2

Wundhaken
Retractors

Ecarteurs
Retractoros
Divaricatori

ohne Zahnung
non- toothed
sans denture
sin dentada
no dentata

Gezahnt
toothed
denture
dentada
dentata

Mamaplasty Retractors



330 mm – 13 "	EG-185-33-A	EG-185-33-B	EG-185-33-C
420 mm – 16½ "	EG-185-42-A	EG-185-42-B	EG-185-42-C
abgewinkelt <i>angled</i>	starr <i>rigid</i>	biegsam <i>malleable</i>	Schaft isoliert <i>Shaft insulated</i>
angulé <i>angulado</i> angolato	rigide <i>rigido</i>	maléable <i>maleable</i> flessibile	Tige isolée <i>Tija aislada</i> Asta isolata













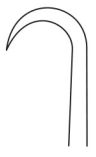

330 mm – 13 "	EG-185-33-A1	EG-185-33-B1	EG-185-33-C1
420 mm – 16½ "	EG-185-42-A1	EG-185-42-B1	EG-185-42-C1
	starr <i>rigid</i>	biegsam <i>malleable</i>	Schaftisoliert <i>Shaftinsulated</i>
	rigide <i>rigido</i>	maléable <i>maleable</i> flessibile	Tige isolée <i>Tija aislada</i> Asta isolata

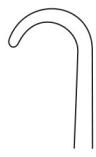

	x = 25mm	x = 33 mm
315 mm – 12½ "	EG-185-31-A	EG-185-31-B
halbstarr <i>semi rigid</i>		
semi rigide <i>semi rigido</i>		

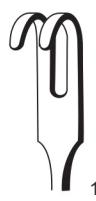





1:2

 1:1	 1:1	 1:1	 1:1	 1:1	 1:1
Volkmann					
215 mm – 8 $\frac{1}{2}$ "	EG-186-21-A	EG-186-21-B	EG-186-21-C	EG-186-21-D	EG-186-21-E
scharf <i>sharp</i> pointu <i>agudo</i> acuto					
 1:1	 1:1	 1:1	 1:1	 1:1	 1:1
215 mm – 8 $\frac{1}{2}$ "	EG-186-21-A1	EG-186-21-B1	EG-186-21-C1	EG-186-21-D1	EG-186-21-E1
stumpf <i>blunt</i> mousse <i>romo</i> smusso					

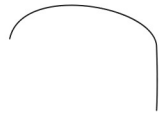

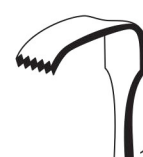

1:2

 1:1	 1:1	 1:1
Strandell-Stille		
190 mm – 7 $\frac{1}{2}$ "	EG-186-19-A	EG-186-19-B
	Fig. 1	Fig. 2
gezahnt <i>saw edge</i> dentelé <i>dentado</i> dentato		

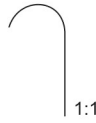

1:2

 1:1	 1:1	 1:1
Senn-Mueller		
160 mm – 6 $\frac{1}{4}$ "	EG-186-16-A	EG-186-16-B
scharf <i>sharp</i> pointu <i>agudo</i> acuto		stumpf <i>blunt</i> mousse <i>romo</i> smusso

Plastic Surgery

Self-Retaining Retractors Wound Spreader



Meyerding

	18 mm x 7 mm	10 mm x 3 mm
180 mm – 7 "	RM-187-18-A	RM-187-18-B

	16 mm x 5 mm	7 mm x 4 mm
180 mm – 7 "	RM-187-18-A1	RM-187-18-B1

	10 mm x 4 mm	7 mm x 4 mm
180 mm – 7 "	RM-187-18-A2	RM-187-18-B2

Ragnell-Davis

140 mm – 5 1/2 "	RM-187-14
------------------	------------------

15 mm x 5,5 mm



Alm

	4 x 4	4 x 4	4 x 4
70 mm – 2 3/4 "	RM-187-07-A	RM-187-07-B	RM-187-07-C
100 mm – 4 "	RM-187-10-A	RM-187-10-B	RM-187-10-C

scharf	halbscharf	stumpf
sharp	semi sharp	blunt
pointu	semi pointu	mousse
agudo	semi agudo	romo
acuto	semi acuto	smusso



Holtzheimer

	4 x 4	4 x 4
100 mm – 4 "	RM-187-10-A1	RM-187-10-B1

scharf	stumpf
sharp	blunt
pointu	mousse
agudo	romo
acuto	smusso

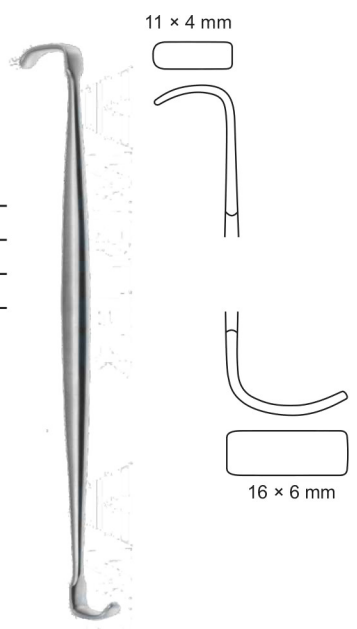

RAGNELL

160 mm – 6 1/2 "	RM-187-16
------------------	------------------

Retractors



Freeman

	x = 22 mm
100 mm – 4 "	EG-188-10-A

scharf
sharp
pointu
agudo
acuto



Freeman

	x = 38 mm
100 mm – 4 "	EG-188-10-B

scharf
sharp
pointu
agudo
acuto



Gorney

	x = 38 mm
75 mm – 3 "	EG-188-07

scharf
sharp
pointu
agudo
acuto

Retractors



1:2



1:1

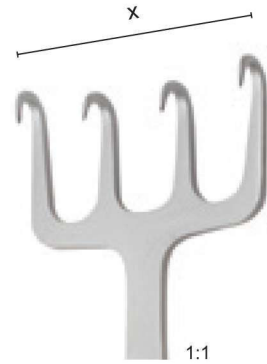

1:1

Freeman

	x = 22mm	x = 38 mm
180 mm - 7"	EG-189-18-A	EG-189-18-B

scharf
sharp
pointu
agudo
acuto

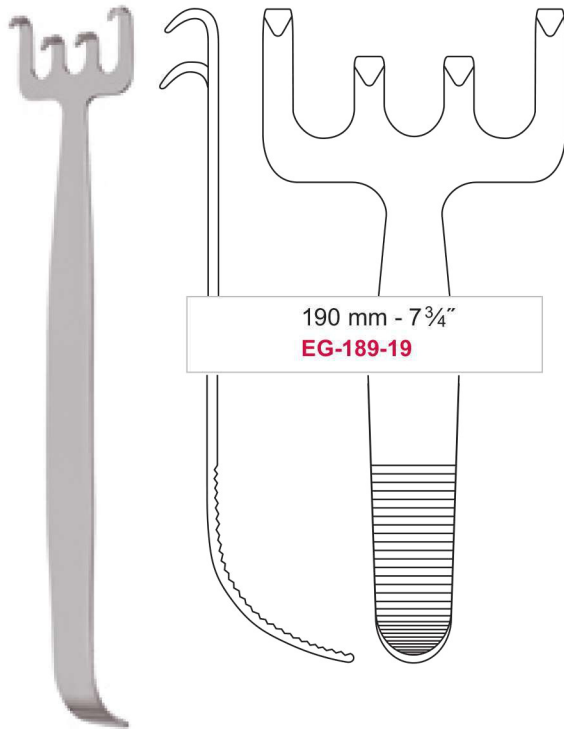

Walter

190 mm - 7 3/4"
EG-189-19



1:2

Yancoskie

	x = 150 mm
180 mm – 7 "	EG-190-18-A

scharf
sharp
pointu
agudo
acuto



Farabeuf-Baby

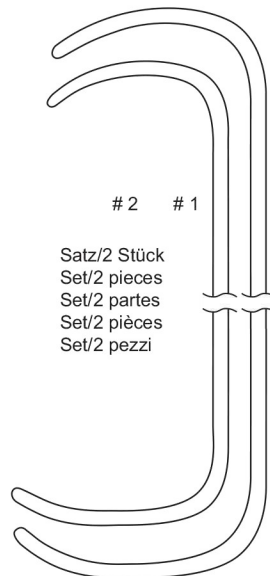

2 # 1
Satz/2 Stück
Set/2 pieces
Set/2 partes
Set/2 pièces
Set/2 pezzi

acuto

B = 17 × 32 mm	
# 1	# 2
A = 10 × 25 mm	A = 10 × 30 mm
	B = 17 × 35 mm
120 mm	
EG-190-18-C	

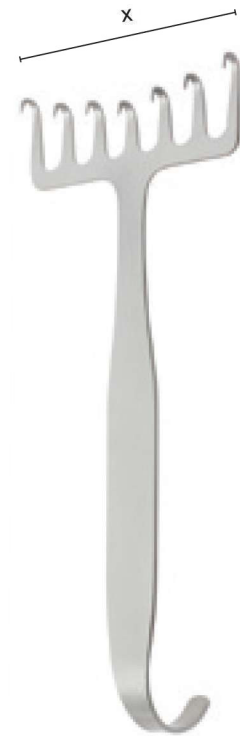

1:2

Coronal lift

	x = 70 mm
180 mm – 7 "	EG-190-18-B

scharf
sharp
pointu
agudo

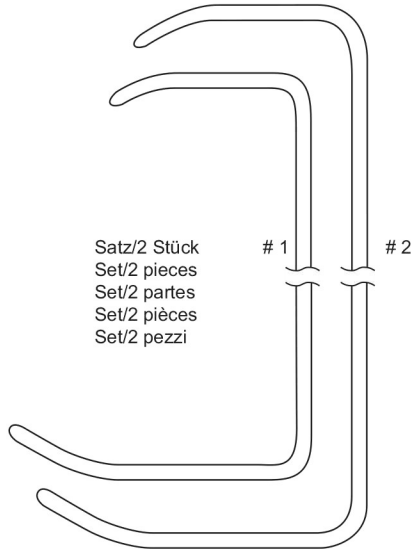

Satz/2 Stück
Set/2 pieces
Set/2 partes
Set/2 pièces
Set/2 pezzi

1

2

# 1	# 2
A = 15 × 23 mm	A = 15 × 28 mm
B = 15 × 37 mm	B = 15 × 40 mm
210 mm	
EG-190A-18-A	

Parker-Langenbeck

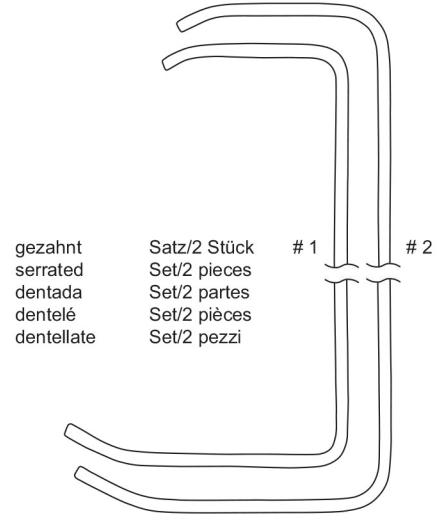

gezahnt
serrated
dentada
dentelée
dentellate

Satz/2 Stück
Set/2 pieces
Set/2 partes
Set/2 pièces
Set/2 pezzi

1

2

# 1	# 2
A = 15 × 24 mm	A = 15 × 28 mm
B = 15 × 36 mm	B = 15 × 40 mm
210 mm	
EG-190A-18-B	

Parker-Langenbeck



175 mm

EG-190A-17-A

Daniel-Gubisch

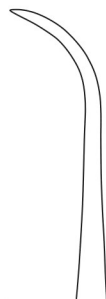

175 mm

EG-190A-17-B

Daniel-Gubisch

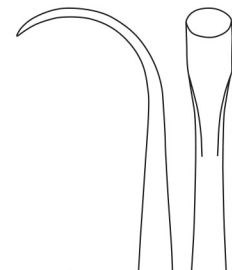

160 mm

EG-190A-17-C

Daniel-Gubisch

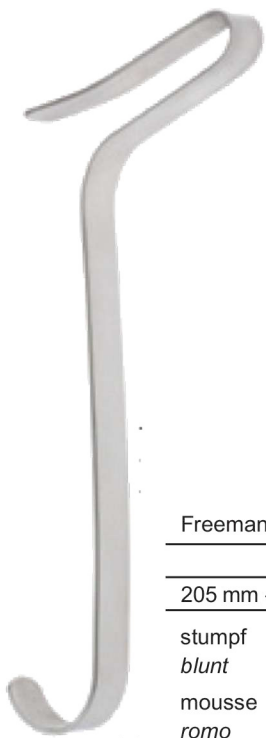

1:2

Freeman

	$x = 12\text{mm}$	$x = 25\text{mm}$
205 mm – 8"	EG-191-20-A	EG-191-20-B

stumpf
blunt
mousse
romo
smusso



1:1



1:1



1:2

Ferreira

	$x = 23\text{mm} / y = 120\text{mm}$
100 mm – 4"	EG-191-10

stumpf
blunt
mousse
romo
smusso

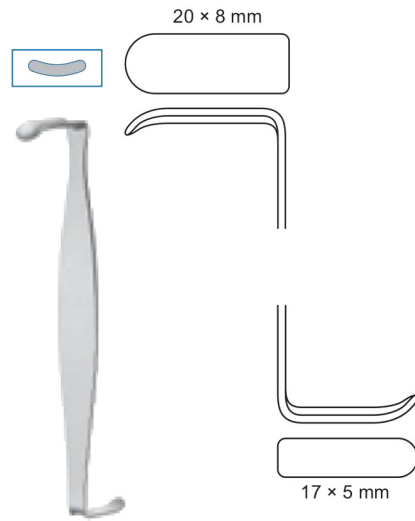

Coronal lift

	$x = 70\text{mm}$
11 cm – 4 $\frac{3}{8}$ "	EG-191-11

scharf
sharp
pointu
agudo
acuto

Plastic Surgery

Soft Tissue Retractors for Maxillo Facial Surgery

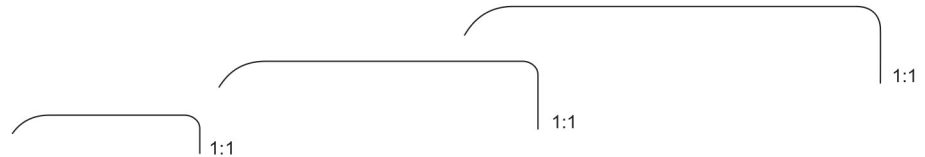

Obwegeser

	7 mm x 25 mm	10 mm x 42 mm	12 mm x 55 mm
215 mm – 8 ₂ "	EG-192-21-A	EG-192-21-B	EG-192-21-C



1:3

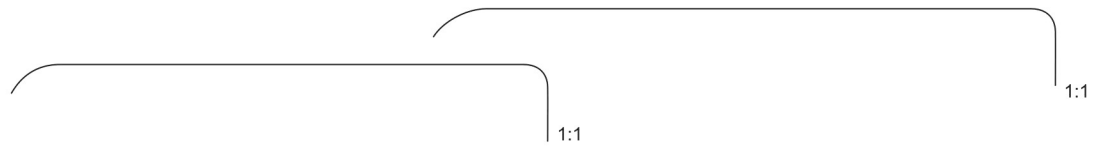

	14 mm x 70 mm	16 mm x 80 mm
215 mm – 8 ₂ "	EG-192-21-D	EG-192-21-E

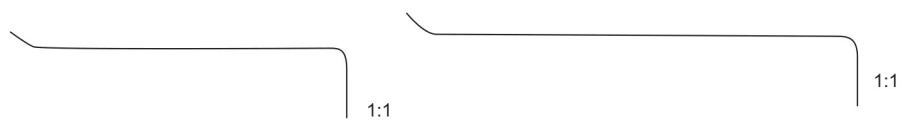

Obwegeser

	13 mm x 42 mm	12 mm x 60 mm
220 mm – 8 ₄ "	EG-192-22-A	EG-192-22-B

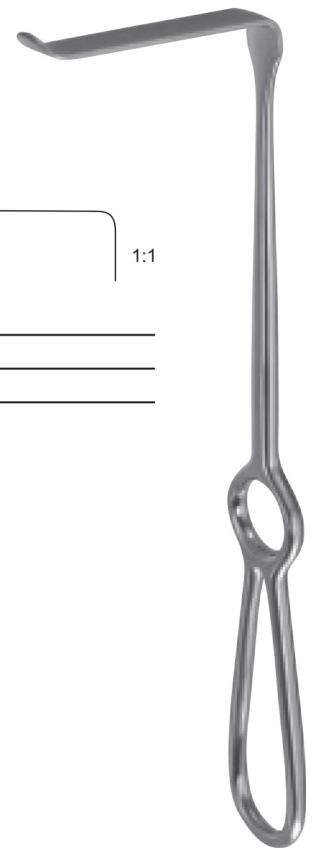

1:2

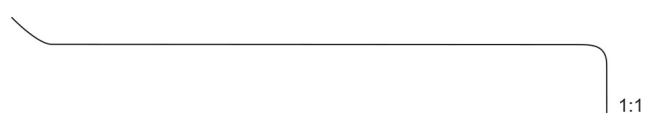

	16 mm x 80 mm
220 mm – 8 ₄ "	EG-192-22-C

Plastic Surgery

Soft Tissue Retractors for Maxillo



1:2

Obwegeser

	44 mm x 9,5 mm	70 mm x 11,5 mm
220 mm – 8 1/2"	EG-193-22-A	EG-193-22-B

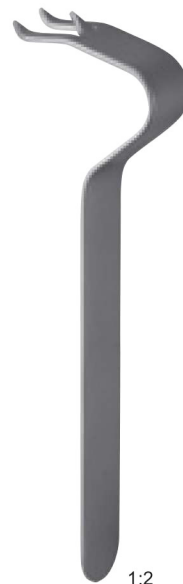

1:2

Obwegeser
155 mm – 6"

EG-193-15



50 x 10 mm



Aufricht Daniel

110 mm – 6"

EG-193-11



1:2

Obwegeser

	8 mm	10 mm
	EG-193-16-A	EG-193-16-B

biegsam
160 mm – 6 1/4"

malléable
flexible
flessibile