

Plastic Surgery

Needle Holder



Derf
125 mm – 5 "
EG-197-12



Gubisch
125 mm – 5 "
EG-197-13



Crile-Murray
150 mm – 6 "
EG-197-15



Crile-Wood		
150 mm – 6 "	EG-197-15-A	EG-197-15-TC
180 mm – 7 "	EG-197-18	EG-197-18-TC
200 mm – 8 "	EG-197-20	EG-197-20-TC



Hegar-Baumgartner

140 mm – 5 $\frac{1}{4}$ "	EG-198-14
140 mm – 5 $\frac{1}{4}$ "	EG-198-14-TC



Baby-Crile-Wood

150 mm – 6"	EG-198-15-TC
	EG-198-15

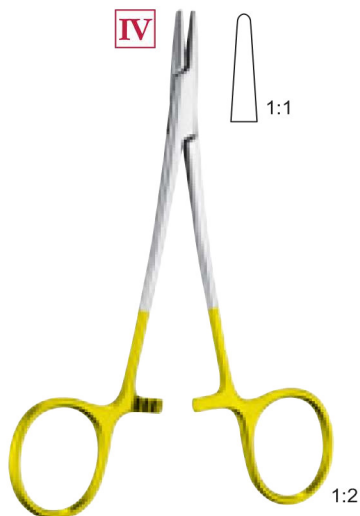

Webster

130 mm – 5"	EG-198-13
130 mm – 5"	EG-198-13-TC

glatt
smooth
lisse
liso
liscio



Ma thie u- Ols en

140 mm – 5 $\frac{1}{2}$ "	EG-198-14-A	EG-198-14-A-TC
170 mm – 6 $\frac{1}{4}$ "	EG-198-17	EG-198-17-TC
200 mm – 8"	EG-198-20	EG-198-20-TC

Plastic Surgery

Needle Holder



1:2

IV



1:1

II

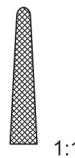

1:1

Halsey

130 mm – 5"	EG-199-13-A	EG-199-13-B
130 mm – 5"	EG-199-13-A-TC	EG-199-13-B-TC

glatt
smooth

lisse
liso
liscio

gerieft
serrated

strié
estriada
zigrinato



Methieu HM

140 mm	EG-199-14A-TC
170 mm	EG-199-17A-TC
200 mm	EG-199-20A-TC
240 mm	EG-199-24A-TC



II

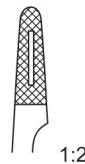

1:2

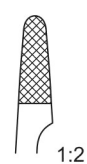

1:2

Olsen-Hegar

120 mm – 4 ₄ "	EG-199-12	EG-199-12-TC
140 mm – 5 ₂ "	EG-199-14	EG-199-14-TC
170 mm – 6 ₄ "	EG-199-17	EG-199-17-TC
190 mm – 7 ₂ "	EG-199-19	EG-199-19-TC

Needle Holder

I

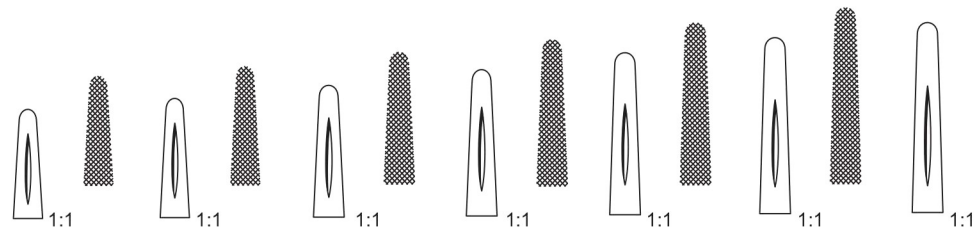

Mayo-Hegar

140 mm – 5 1/2"	160 mm – 6 1/4"	180 mm – 7"	200 mm – 8"	240 mm – 9 1/2"	260 mm – 10 1/4"	300 mm – 12"
RM-1100-14	RM-1100-16	RM-1100-18	RM-1100-20	RM-1100-24	RM-1100-26	RM-1100-30

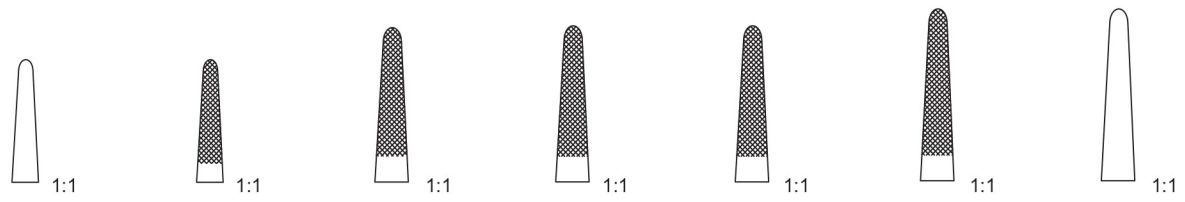

Mayo-Hegar

140 mm – 5 1/2"	160 mm – 6 1/4"	180 mm – 7"	200 mm – 8"	240 mm – 9 1/2"	260 mm – 10 1/4"	300 mm – 12"
RM-1100-14-A-TC	RM-1100-16-A-TC	RM-1100-18-A-TC	RM-1100-20-A-TC	RM-1100-24-A-TC	RM-1100-26-A-TC	RM-1100-30-A-TC

Needle Holder

II

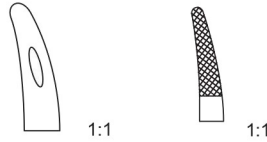

Gillies

160 mm – 6¼"

EG-1101-16-A

EG-1101-16-B

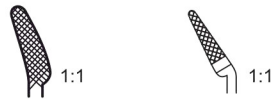

Gillies

145 mm – 5¾"

EG-1101-14-A

EG-1101-14-B



Foster-Gillies

120 mm – 4¼"



EG-1101-12-A

gerade, gerieft
straight, serrated
droit, strié
recta, estriada
retto, zigrinato



EG-1101-12-B

gerade, glatt
straight, smooth
droit, lisse
recta, lisa
retto, liscio



EG-1101-12-C

gebogen, gerieft
curved, serrated
courbe, strié
curva, estriada
curvo, zigrinato







EG-1101-12-D

gebogen, glatt
curved, smooth
courbe, lisse
curva, lisa
curvo, liscio

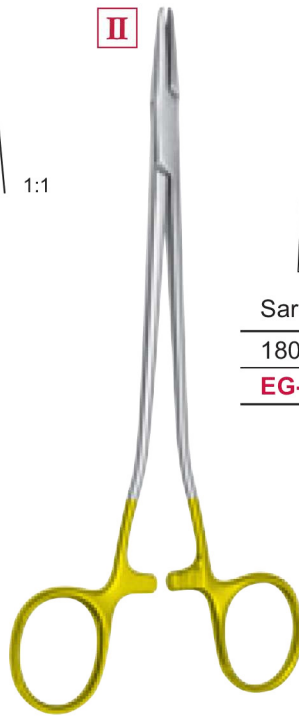
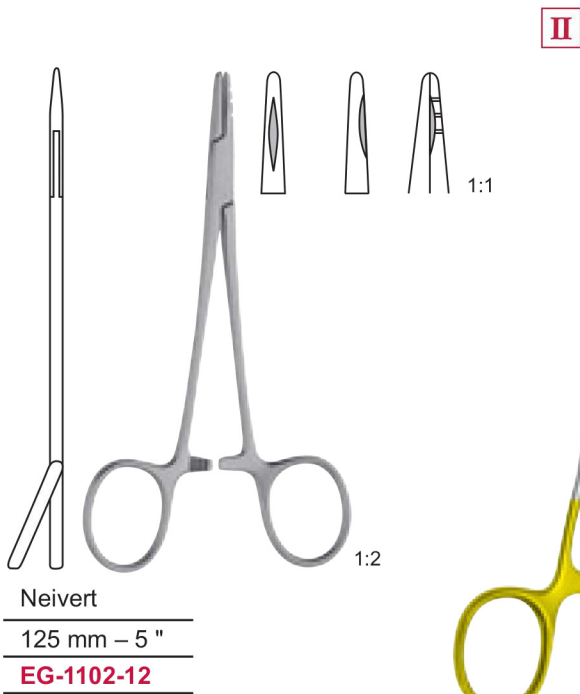

Plastic Surgery

Needle Holder



 1:1	 1:1	 1:1
Sarot		
180 mm – 7 "	200 mm – 8 "	260 mm – 10¼"
EG-1102-18-A-TC	EG-1102-20-A-TC	EG-1102-26-TC



 1:1	
Heaney	
160 mm – 6¼"	EG-1102-16-TC
180 mm – 7 "	EG-1102-18-B-TC
200 mm – 8 "	EG-1102-20-B-TC

Needle Holder

II

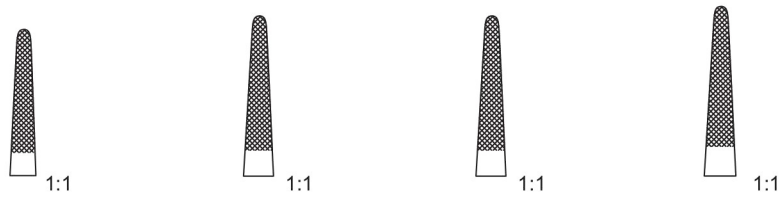
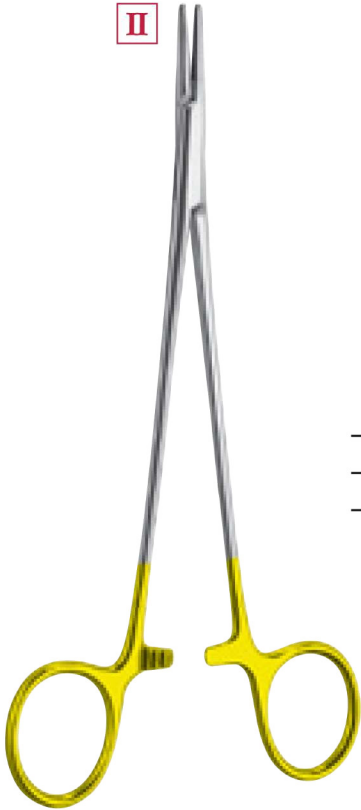

De Bakey

180 mm – 7 "	200 mm – 8 "	230 mm – 9 "	260 mm – 10 ₄ "
EG-1103-18-A-TC	EG-1103-20-A-TC	EG-1103-23-A-TC	EG-1103-26-TC

III

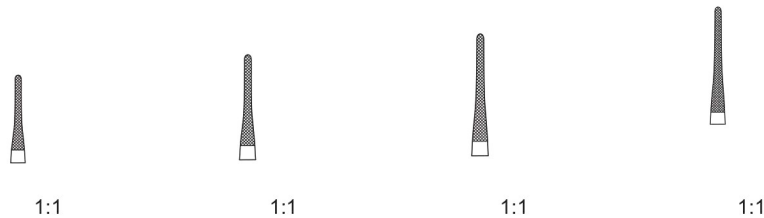

Vascular

140 mm – 5 ₂ "	180 mm – 7 "	200 mm – 8 "	230 mm – 9 "
EG-1103-14-TC	EG-1103-18-B-TC	EG-1103-20-B-TC	EG-1103-23-B-TC

Needle Holder



1:1



1:1



1:1

130 mm – 5 "	150 mm – 5 ³ / ₄ "	170 mm – 6 ³ / ₄ "
EG-1104-13	EG-1104-15	EG-1104-17

mit Spezialbeschichtung im Maul
with special coated jaw
 mors avec couche special
boca con capa especial
 morso "diamant dust"



1:1



1:1



1:1

180 mm – 7 "	200 mm – 8 "	230 mm – 9 "
EG-1104-18	EG-1104-20	EG-1104-23

mit Spezialbeschichtung im Maul
with special coated jaw
 mors avec couche special
boca con capa especial
 morso "diamant dust"



Nagata HM	
115 mm	130 mm
EG-1104-11	EG-1104-13-A

II



Lichtenberg

170 mm – 6 $\frac{1}{4}$ "	EG-1105-17-TC		EG-1105-17
200 mm – 8"		EG-1105-20-TC	EG-1105-20

III



Diethrich

160 mm – 6 $\frac{1}{4}$ "	EG-1105-16-TC
180 mm – 7"	EG-1105-16-A-TC
200 mm – 8"	EG-1105-20-A-TC
230 mm – 9"	EG-1105-23-TC
250 mm – 9 $\frac{1}{4}$ "	EG-1105-25-TC

II



III



Ryder

130 mm – 5"	EG-1105-13-A-TC	EG-1105-13-B-TC	EG-1105-13-C-TC
150 mm – 6"	EG-1105-15-A-TC	EG-1105-15-B-TC	EG-1105-15-C-TC
180 mm – 7"	EG-1105-18-A1-TC	EG-1105-18-B1-TC	EG-1105-18-C1-TC
200 mm – 8"	EG-1105-20-A1-TC	EG-1105-20-B1-TC	EG-1105-20-C1-TC
230 mm – 9"	EG-1105-23-A-TC	EG-1105-23-B-TC	EG-1105-23-E-TC
260 mm – 10 $\frac{1}{4}$ "	EG-1105-26-A-TC	EG-1105-26-B-TC	EG-1105-26-F-TC

Mini-Ryder



mit Spezialbeschichtung im Maul
with special coated jaw

Mors avec couche special
Boca con capa especial
Morso "diamant dust"



Best Quality Steel as required by our reliable and valued customers. Our skilled craftsman give life to the metal and give it the shape that will go through series of complicated process. The measurement and shape are checked according to sample. All instruments are inspected for every process they have been gone through.

Needle Holder

IV



Castroviejo-
Jacobson



140 mm – 5 ₂ "	EG-1106-14-A	EG-1106-14-A-TC	EG-1106-14-B	EG-1106-14-B-TC
150 mm – 6"	EG-1106-15-A	EG-1106-15-A-TC	EG-1106-15-B	EG-1106-15-B-TC
180 mm – 7"	EG-1106-18-A	EG-1106-18-A-TC	EG-1106-18-B	EG-1106-18-B-TC
210 mm – 8 ₄ "	EG-1106-21-A	EG-1106-21-A-TC	EG-1106-21-B	EG-1106-21-B-TC

glattes Maul
smooth jaws
mors lisse
boca lisa
morso liscio

gerade, ohne Sperre
straight, without ratchet
droit, sans crémaillère
recta, sin cremallera
retto, senza cremagliera

gerade, mit Sperre
straight, with ratchet
droit, avec crémaillère
recta, con cremallera
retto, con cremagliera



140 mm – 5 ₂ "	EG-1106-14-A1	EG-1106-14-A1-TC	EG-1106-14-B1	EG-1106-14-B1-TC
150 mm – 6"	EG-1106-15-A1	EG-1106-15-A1-TC	EG-1106-15-B1	EG-1106-15-B1-TC
180 mm – 7"	EG-1106-18-A1	EG-1106-18-A1-TC	EG-1106-18-B1	EG-1106-18-B1-TC
210 mm – 8 ₄ "	EG-1106-21-A1	EG-1106-21-A1-TC	EG-1106-21-B1	EG-1106-21-B1-TC

glattes Maul
smooth jaws
mors lisse
boca lisa
morso liscio

gebogen, ohne Sperre
curved, without ratchet
courbe, sans crémaillère
curva, sin cremallera
curvo, senza cremagliera

gebogen, mit Sperre
curved, with ratchet
courbe, avec crémaillère
curva, con cremallera
curvo, con cremagliera



1:2

Barraquer



145 mm – 5 ₄ "	EG-1106-14-A2	EG-1106-14-B2
---------------------------	----------------------	----------------------

gerade
straight
droit
recta
retto

gebogen
curved
courbe
curva
curvo

Plastic Surgery

Micro Blade Holder --- Micro Blades



Castroviejo

x = 11.0 mm x 0.75 mm				
140 mm - 5 1/2"	EG-1107-14-A	EG-1107-14-B	EG-1107-14-C	EG-1107-14-D
ohne Sperre, feines Maul <i>without ratchet, fine jaws</i>	gerade <i>straight</i>	gebogen <i>curved</i>	gerade, diamantiert <i>straight, diamond coated</i>	gebogen, diamantiert <i>curved, diamond coated</i>
sans crémaillère, mors fine <i>sin cremallera, boca fina</i>	droit <i>recta</i>	courbe <i>curva</i>	droit, diamanté <i>recta, diamantada</i>	courbe, diamanté <i>curva, diamantada</i>
senza cremagliera, morso fino	retto	curvo	retto, diamantato	curvo, diamantato







1:1

x = 11.0 mm x 0.75 mm				
140 mm - 5 1/2"	EG-1107-14-A1	EG-1107-14-B1	EG-1107-14-C1	EG-1107-14-D1
mit Sperre, feines Maul <i>with ratchet, fine jaws</i>	gerade <i>straight</i>	gebogen <i>curved</i>	gerade, diamantiert <i>straight, coated</i>	gebogen, <i>curved, coated</i>
avec crémaillère, mors fine <i>con cremallera, boca fina</i>	droit <i>recta</i>	courbe <i>curva</i>	droit, diamanté <i>recta, diamantada</i>	courbe, diamanté <i>curva, diamantada</i>
con cremagliera, morso fino	retto	curvo	retto, diamantato	curvo, diamantato





Micro Needle Holder

EG-1108-18-A

EG-1108-18-D

Jacobson	 1:1	 1:1	 1:1	 1:1
	x = 1mm	x = 1mm	x = 1mm	x = 1 mm
180 mm – 7 "		EG-1108-18-B	EG-1108-18-C	
ohne Sperre <i>without ratchet</i>	gerade <i>straight</i>	gebogen <i>curved</i>	gerade, diamantiert <i>straight, diamond coated</i>	gebogen, diamantiert <i>curved, diamond coated</i>
sans crémaillère <i>sin cremallera</i>	droit <i>recta</i>	courbe <i>curva</i>	droit, diamanté <i>recta, diamantada</i>	courbe, diamanté <i>curva, diamantada</i>
senza cremagliera	retto	curvo	retto, diamantato	curvo, diamantato

	x = 1mm	x = 1mm	x = 1mm	x = 1 mm
180 mm – 7 "	EG-1108-18-A1	EG-1108-18-B1	EG-1108-18-C1	EG-1108-18-D1
mit Sperre <i>with ratchet</i>	gerade <i>straight</i>	gebogen <i>curved</i>	gerade, diamantiert <i>straight, diamond coated</i>	gebogen, diamantiert <i>curved, diamond coated</i>
avec crémaillère <i>con cremallera</i>	droit <i>recta</i>	courbe <i>curva</i>	droit, diamanté <i>recta, diamantada</i>	courbe, diamanté <i>curva, diamantada</i>
con cremagliera	retto	curvo	retto, diamantato	curvo, diamantato

	 1:1	 1:1	 1:1	 1:1
	x = 1mm	x = 1mm	x = 1mm	x = 1 mm
180 mm – 7 "	EG-1108-18-A-TC	EG-1108-18-B-TC	EG-1108-18-C-TC	EG-1108-18-D-TC
Sperre <i>ratchet</i>	gerade, glatt <i>straight, smooth</i>	gebogen, glatt <i>curved, smooth</i>	gerade, gerieft <i>straight, serrated</i>	gebogen, gerieft <i>curved, serrated</i>
sans crémaillère <i>sin cremallera</i>	droit, lisse <i>recta, liso</i>	courbe, lisse <i>curva, lisa</i>	droit, strié <i>recta, estriada</i>	courbe, strié <i>curva, estriada</i>
senza cremagliera	retto, liscio	curvo, liscio	retto, zigrinato	curvo, zigrinato





180 mm – 7 "	EG-1108-18-A1-TC	EG-1108-18-B1-TC	EG-1108-18-C1-TC	EG-1108-18-D1-TC
1 mm				
mit Sperre <i>ratchet</i>	glatt <i>straight, smooth</i>	gebogen, glatt <i>curved, smooth</i>	gerade, <i>straight,</i>	gebogen, gerieft <i>curved, serrated</i>
avec crémaillère <i>con cremallera</i>	droit, lisse <i>recta, liso</i>	courbe, lisse <i>curva, lisa</i>	droit, strié <i>recta, estriada</i>	courbe, strié <i>curva, estriada</i>
	retto, liscio	curvo, liscio	retto, zigrinato	curvo, zigrinato



1:1

Plastic Surgery

Micro Needle Holder with Rounded Handle

Barraquer	 1:1	 1:1	 1:1	 1:1	
140 mm – 5 $\frac{1}{2}$ "	8 mm Ø	EG-1109-14-A	EG-1109-14-B	EG-1109-14-C	EG-1109-14-D
ohne Sperre, sehr feines Maul <i>without ratchet, extra delicate jaws</i>	gerade <i>straight</i>	gebogen <i>curved</i>	gerade, diamantiert <i>straight, diamond coated</i>	gebogen, <i>curved, diamond coated</i>	
sans crémaillère, mors très fine <i>sin cremallera, boca muy fina</i>	droit <i>recta</i>	courbe <i>curva</i>	droit, diamanté <i>recta, diamantada</i>	courbe, diamanté <i>curva, diamantada</i>	
senza cremagliera, morso molto finoretto	retto	curvo	retto, diamantato	curvo, diamantato	



140 mm – 5 $\frac{1}{2}$ "	8 mm Ø	EG-1109-14-A1	EG-1109-14-B1	EG-1109-14-C1	EG-1109-14-D1
mit Sperre, sehr feines Maul <i>with ratchet, extra delicate jaws</i>	gerade <i>straight</i>	gebogen <i>curved</i>	gerade, diamantiert <i>straight, diamond coated</i>	gebogen, <i>curved, diamond coated</i>	
avec crémaillère, mors très fine <i>con cremallera, boca muy fina</i>	droit <i>recta</i>	courbe <i>curva</i>	droit, diamanté <i>recta, diamantada</i>	courbe, diamanté <i>curva, diamantada</i>	
con cremagliera, morso molto fino	retto	curvo	retto, diamantato	curvo, diamantato	

Plastic Surgery

Micro Needle Holder with Rounded



110 mm – 4 1/4 "	8 mm Ø	EG-1110-11-A	EG-1110-11-B
125 mm – 5 "	7mm Ø	EG-1110-12-A	EG-1110-12-B
130mm – 5 "	8mm Ø	EG-1110-13-A	EG-1110-13-B
130mm – 5 "	10mm Ø	EG-1110-13-A1	EG-1110-13-B1
150mm – 6 "	8mm Ø	EG-1110-15-A	EG-1110-15-B
180 mm – 7 "	8mm Ø	EG-1110-18-A	EG-1110-18-B
180mm – 7 "	10mm Ø	EG-1110-18-A1	EG-1110-18-B1

ohne Sperre
without ratchet
sans crémaillère
sin cremallera
senza cremagliera

gerade
straight
droit
recta
retto

gebogen
curved
courbe
curva
curvo

110 mm – 4 1/4 "	8 mm Ø	EG-1110-11-C	EG-1110-11-D
125mm – 5 "	7mm Ø	EG-1110-12-C	EG-1110-12-D
130mm – 5 "	8mm Ø	EG-1110-13-C	EG-1110-13-D
130mm – 5 "	10mm Ø	EG-1110-13-C1	EG-1110-13-D1
150mm – 6 "	8mm Ø	EG-1110-15-C	EG-1110-15-D
180mm – 7 "	8mm Ø	EG-1110-18-C	EG-1110-18-D
180mm – 7 "	10mm Ø	EG-1110-18-C1	EG-1110-18-D1

mit Sperre
with ratchet
avec crémaillère
con cremallera
con cremagliera





gerade
straight
droit
recta
retto

gebogen
curved
courbe
curva
curvo





Plastic Surgery

Micro Needle Holder with Rounded



Yasargil	 1:1	 1:1	 1:1	 1:1
	x = 1mm	x = 1mm	x = 1mm	x = 1 mm
210 mm – 8 ₄ "	EG-1111-21-A	EG-1111-21-B	EG-1111-21-C	EG-1111-21-D
ohne Sperre without ratchet	gerade <i>straight</i>	gebogen <i>curved</i>	diamantiert <i>straight, diamond coated</i>	gebogen, <i>curved, diamond coated</i>
sans crémaillère	droit	courbe	droit, diamanté	courbe, diamanté
sin cremallera	recta	curva	recta, diamantado	curva, diamantado
senza cremagliera	retto	curvo	retto, diamantato	curvo, diamantato

	x = 1mm	x = 1mm	x = 1mm	x = 1 mm
210 mm – 8 ₄ "	EG-1111-21-A1	EG-1111-21-B1	EG-1111-21-C1	EG-1111-21-D1
mit Sperre with ratchet	gerade <i>straight</i>	gebogen <i>curved</i>	diamantiert <i>straight, diamond coated</i>	gebogen, <i>curved, diamond coated</i>
avec crémaillère	droit	courbe	droit, diamanté	courbe, diamanté
con cremallera	recta	curva	recta, diamantada	curva, diamantada
con cremagliera	retto	curvo	retto, diamantato	curvo, diamantato

	 1:1	 1:1	 1:1	 1:1
	x = 1mm	x = 1mm	x = 1mm	x = 1 mm
210 mm – 8 ₄ "	EG-1111-21-A-TC	EG-1111-21-B-TC	EG-1111-21-C-TC	EG-1111-21-D-TC

without ratchet *straight, smooth* *curved, smooth* *straight, serrated* *curved, serrated*

	x = 1mm	x = 1mm	x = 1mm	x = 1 mm
210 mm – 8 ₄ "	EG-1111-21-A1-TC	EG-1111-21-B1-TC	EG-1111-21-C1-TC	EG-1111-21-D1-TC

without ratchet *straight, smooth* *curved, smooth* *straight, serrated* *curved, serrated*

Plastic Surgery

Micro Needle Holder with Rounded



	0.4 x 0.6mm	0.4 x 0.6mm	0.6 x 0.6mm	0.6 x 0.6 mm
200 mm – 8 "	EG-1113-20-A	EG-1113-20-B	EG-1113-20-C	EG-1113-20-D

Titan, mit Sperre
Titanium, with ratchet
 Titane, avec crémaillère
Titanio, con cremallera
 Titanio, con cremagliera

Plastic Surgery

Micro Needle Holder with Rounded

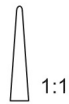

1:1

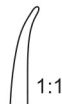

1:1

	0.3 mm x 0.4 mm	0.3 mm x 0.4 mm
180 mm – 7"	EG-1114-14-A	EG-1114-14-B

Titan, mit Sperre
Titanium, with ratchet
 Titane, avec crémaillère
Titanio, con cremallera
 Titanio, con cremagliera

1:2



1:1

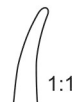

1:1

	0.8 mm x 0.8 mm	0.8 mm x 0.8 mm
185 mm – 7 ¹ / ₄ "	EG-1114-18-A	EG-1114-18-B

Titan, mit Sperre
Titanium, with ratchet
 Titane, avec crémaillère
Titanio, con cremallera
 Titanio, con cremagliera

1:2